



medisana
International



DENTAL INSTRUMENTS Catalogue

DEPARTMENT #	NAME	FROM PAGE#	TO PAGE#
01	ROOT ELEVATORS.	01	18
02	DRESSING FORCEPS.	19	38
03	PERIOSTEAL ELEVATORS.	39	46
04	EXTRACTING FORCEPS.	47	105
05	PERIODONTAL INSTRUMENTS.	106	114
06	SCALERS.	115	132
07	EXCAVATORS.	133	143
08	PROBES AND EXPLORERS.	144	150
09	ENDODONTIC AND NEVER INSTRUMENTS.	151	154
10	CEMENT SPATULAS.	155	159
11	AMALGAM INSTRUMENTS.	160	168
12	BONE CURETTES.	169	176
13	FILLING INSTRUMENTS.	177	206
14	BONE RONGEUR FORCEPS.	207	216
15	MOUTH GAGS AND TONGUE RETRACTORS.	217	222
16	DISSECTING SCISSORS.	223	234
17	TISSUE RETRACTORS.	235	244
18	ARTERY FORCEPS.	245	253
19	NEEDLE HOLDERS.	254	265
20	INSTRUMENTS BOXES.	266	272
21	RUBBER DAM INSTRUMENTS.	273	280
22	CROWN INSTRUMENTS.	281	287
23	AMALGAM CARRIERS.	288	295
24	MOUTH MIRRORS HANDLES.	296	300
25	SCALPLE HANDLES.	301	304
26	HAMMERS.	305	308
27	CARVING INSTRUMENTS.	309	318
28	WAX KNIVES.	319	331
29	IMPRESSION TRAYS.	332	350
30	TRAYS AND BOWLS.	351	359
31	ORTHODONTICS PLIERS.	360	375
32	SISSORS.	376	382

Department

01

ROOT ELEVATORS
WURZELHEBER
ELEVADORES PARA RAICES

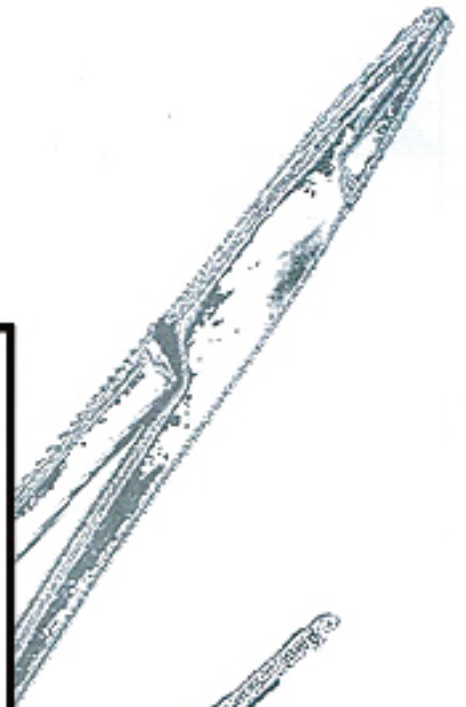
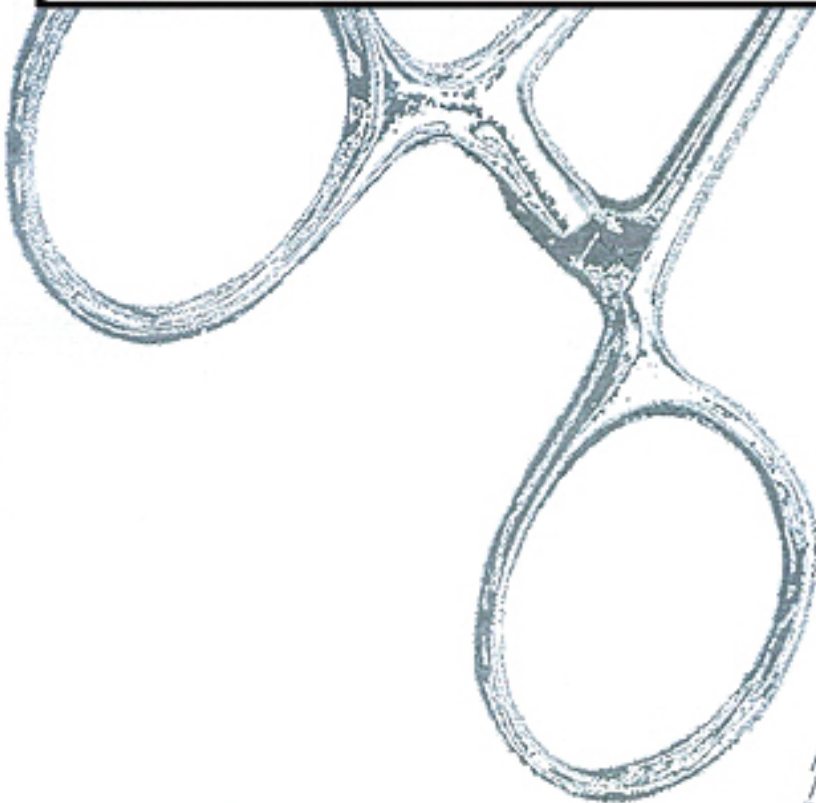
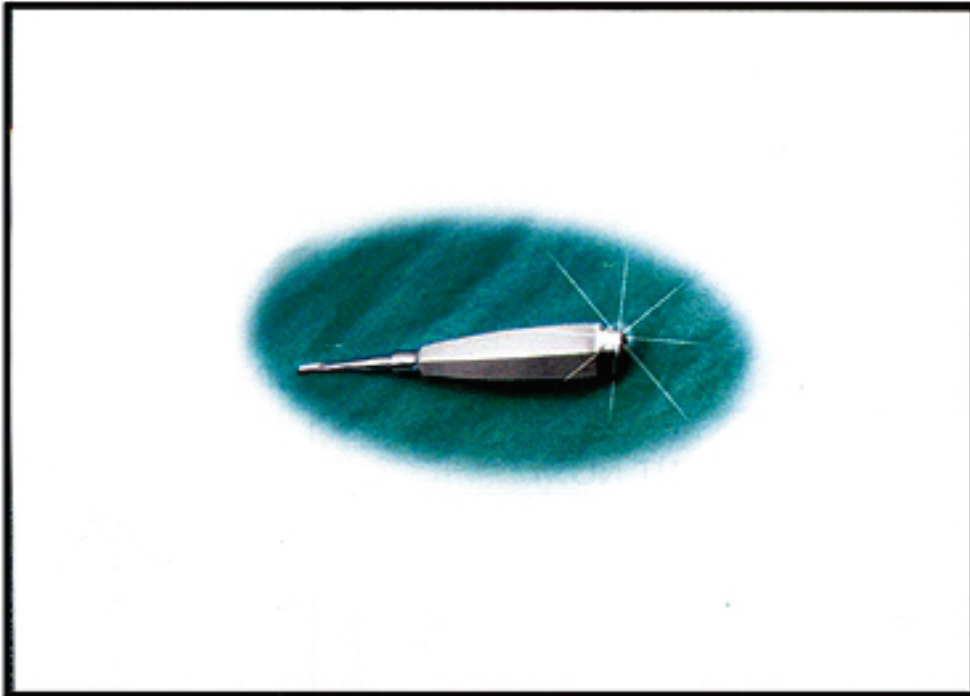

DEPARTMENT NO. 1

FROM
PAGE#

1

TO
PAGE#

18

INSTRUMENTS CATEGORY

ROOT ELEVATORS
WURZELHEBER
ELEVADORES PARA RAICES



01-001-00



01-002-00

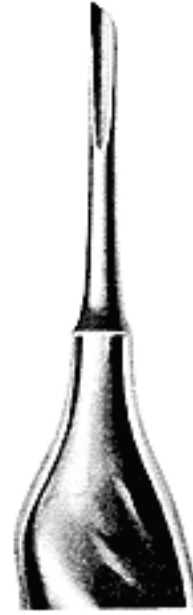

01-003-00



01-004-00



01-005-00

ROOT ELEVATORS
WURZELHEBER
ELEVADORES PARA RAICES



9

01-006-09



8

01-006-08



7

01-006-07



6

01-006-06



14

01-006-14



13

01-006-13



12

01-006-12



11

01-006-11



6

01-006-06
Bein



1
01-007-01
Bein



2
01-007-02



3
01-007-03



4
01-007-04



5
01-007-05



6
01-007-06



7
01-007-07



8
01-007-08



9
01-007-09



10
01-007-10



11
01-007-11



12
01-007-12

ROOT ELEVATORS
WURZELHEBER
ELEVADORES PARA RAICES

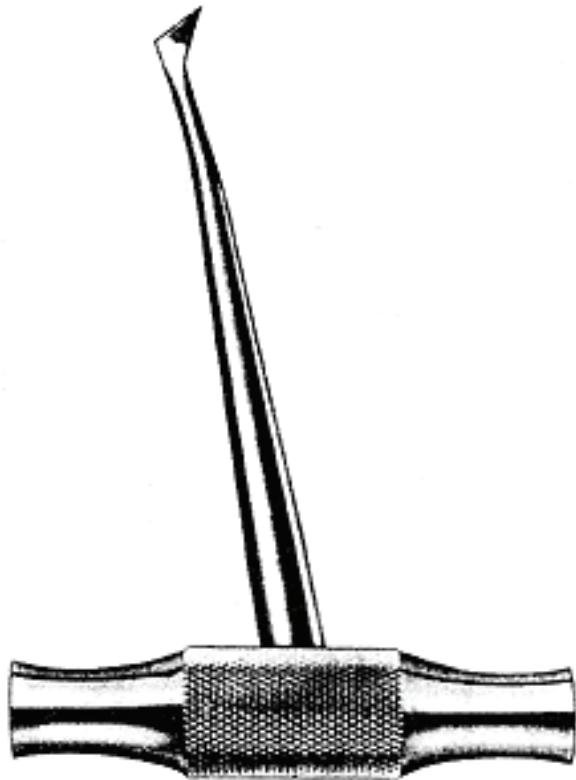

01-058-00
Barry

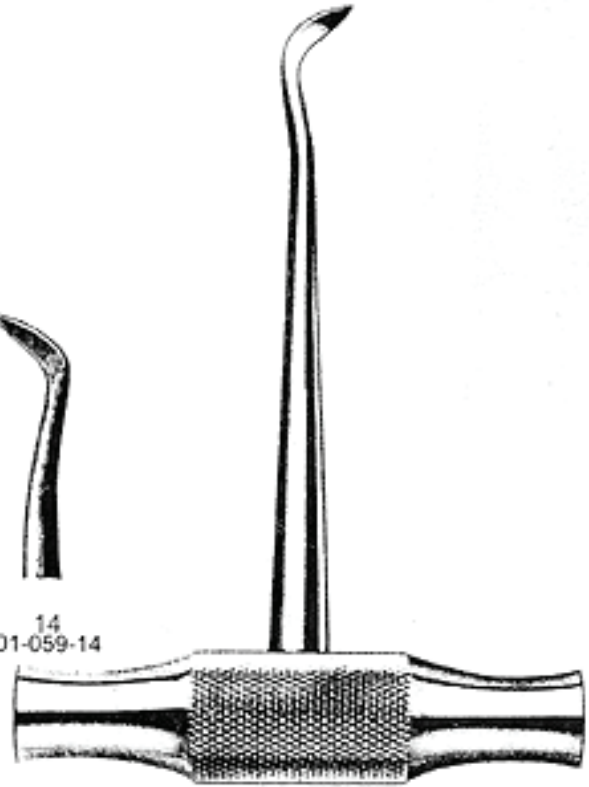
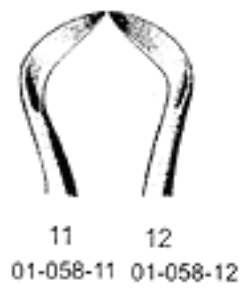

01-059-00
Winter



01-110-00
 Ratzow

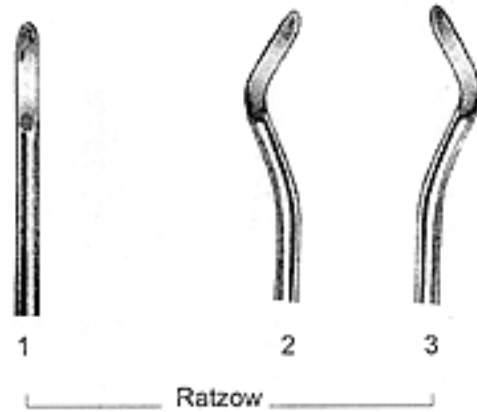

01-110-01 01-110-02 01-110-03



01-111-00
 4.5mm
 Hylin

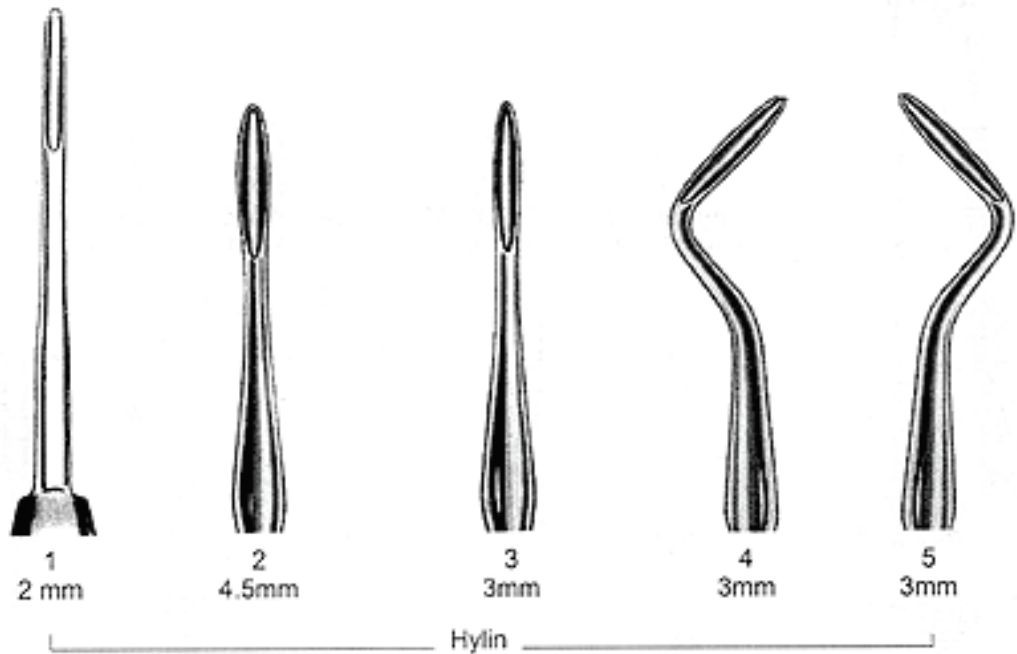

01-111-01 01-111-02 01-111-03 01-111-04 01-111-05

ROOT ELEVATORS
WURZELHEBER
ELEVADORES PARA RAICES

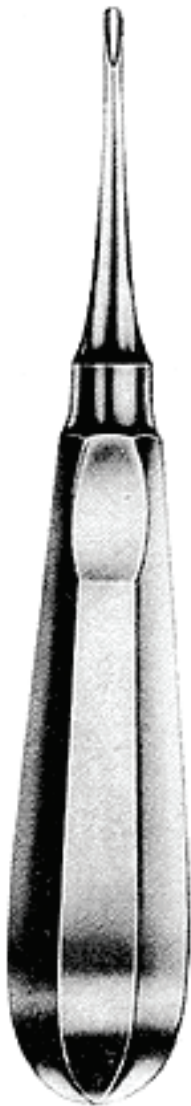

1
01-112-01
Apical 301

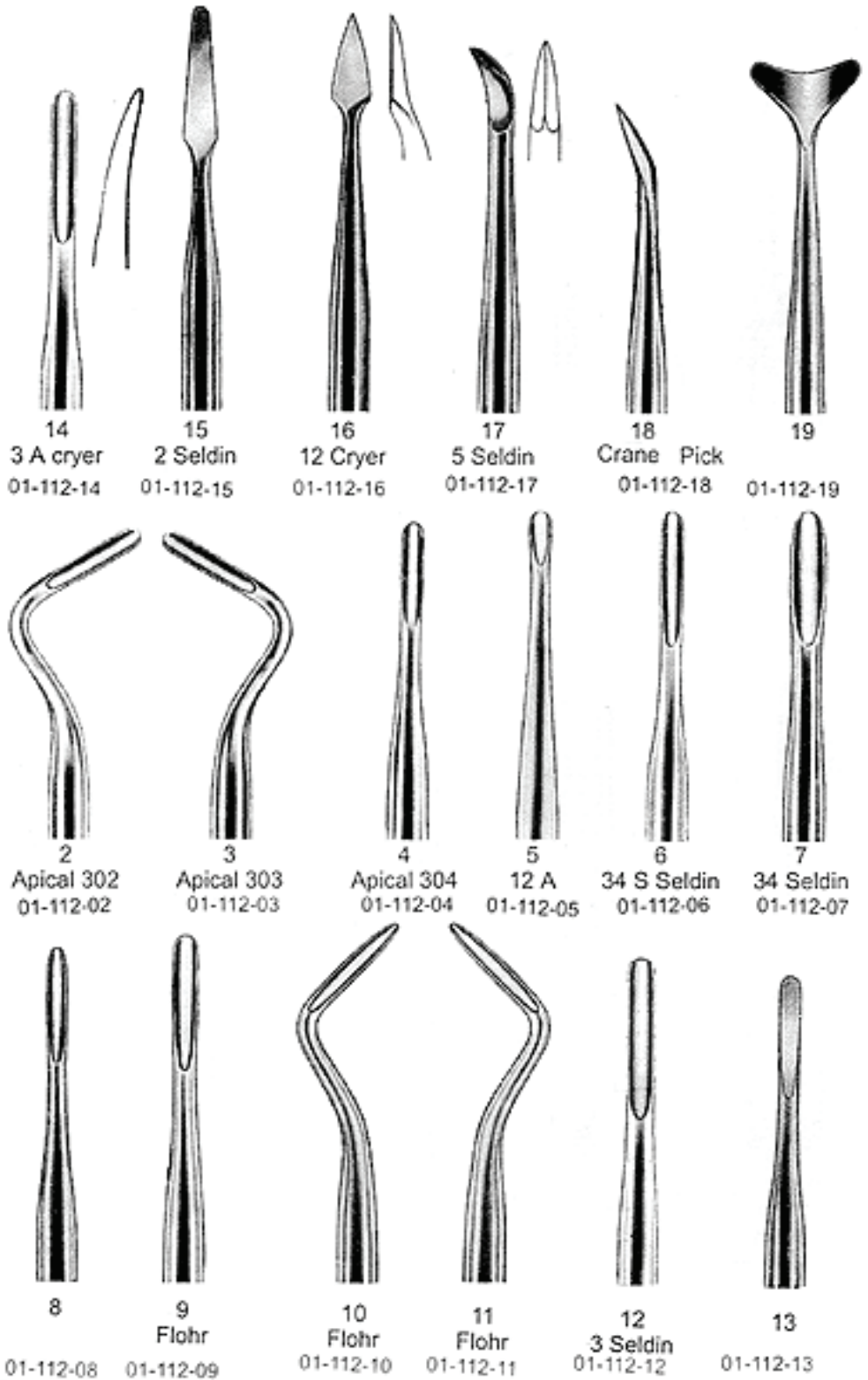

14
3 A cryer
01-112-14

15
2 Seldin
01-112-15

16
12 Cryer
01-112-16

17
5 Seldin
01-112-17

18
Crane Pick
01-112-18

19
01-112-19

2
Apical 302
01-112-02

3
Apical 303
01-112-03

4
Apical 304
01-112-04

5
12 A
01-112-05

6
34 S Seldin
01-112-06

7
34 Seldin
01-112-07

8
01-112-08

9
Flohr
01-112-09

10
Flohr
01-112-10

11
Flohr
01-112-11

12
3 Seldin
01-112-12

13
01-112-13



1
 01-113-01
 Flohr



8
 Heidbrink
 01-113-08



9
 Heidbrink
 01-113-09



10
 Heidbrink
 01-113-10



11
 01-113-11



12
 01-113-12



2
 Flohr
 01-113-02



3
 Flohr
 01-113-03



4
 Flohr
 01-113-04



5
 Flohr
 01-113-05



6
 Friedman
 01-113-06

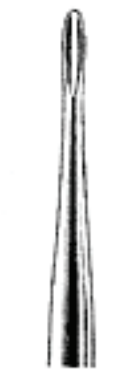

14
 01-113-14



15
 01-113-15



16
 01-113-16



17
 01-113-17



18
 01-113-18

ROOT ELEVATORS
WURZELHEBER
ELEVADORES PARA RAICES

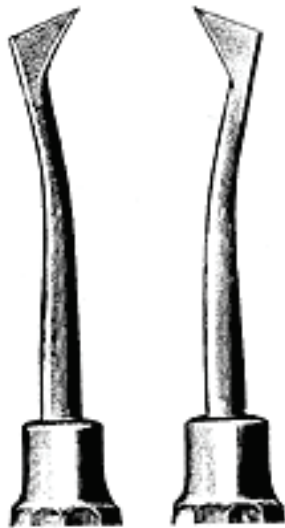

23 24
Cryer
01-114-23 01-114-24



81
01-114-81

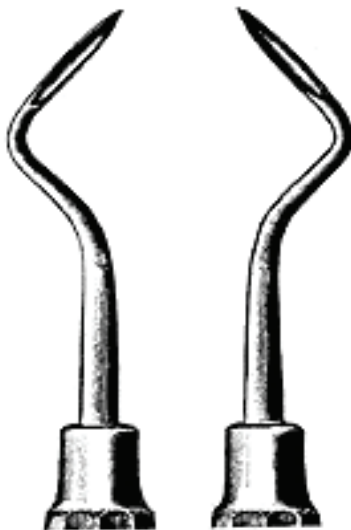

4 5
Apical
01-114-04 01-114-05



6
01-114-06



81
01-114-00



ROOT ELEVATORS
 WURZELHEBER
 ELEVADORES PARA RAICES

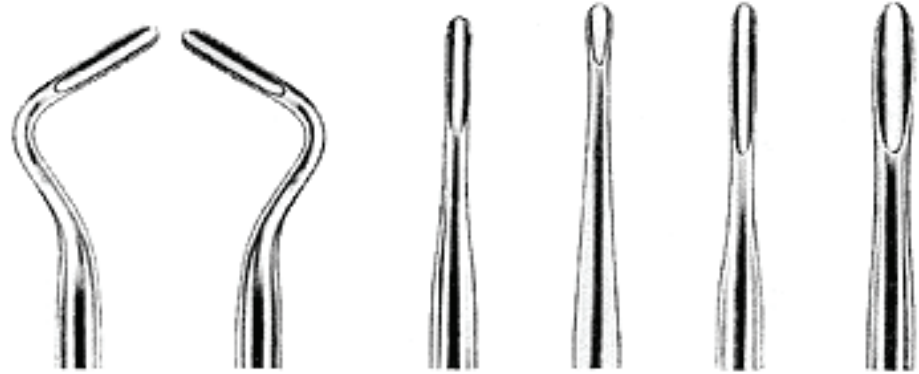

2 Apical 302 01-115-02 3 Apical 303 01-115-03 4 Apical 304 01-115-04 5 12A 01-115-05 6 34S Seldin 01-115-06 7 34 Seldin 01-115-07

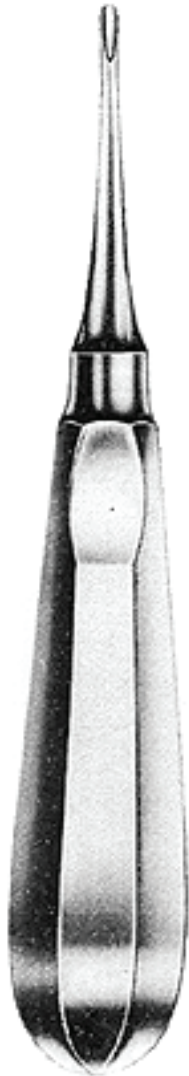

1 01-115-01
 Apical 301



14 3A Cryer 01-115-14



15 2 Seldin 01-115-15



16 12 Cryer 01-115-16



17 5 Seldin 01-115-17



18 Crane Pick 01-115-18



19 01-115-19



8 01-115-08



9 Flohr 01-115-09



10 Flohr 01-115-10



11 Flohr 01-115-11



12 3 Seldin 01-115-12



13 01-115-13

ROOT ELEVATORS
WURZELHEBER
ELEVADORES PARA RAICES



20
01-116-20



21
01-116-21

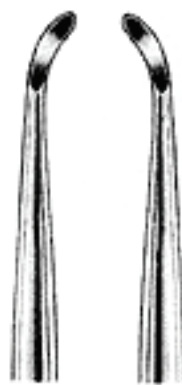

22 Miller 1
01-116-22



23 Miller 2
01-116-23



24 Miller 3
01-116-24



25 Miller 4
01-116-25

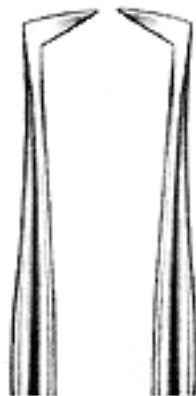

26 01-116-26



27 01-116-27



28 01-116-28



29 01-116-29



30 01-116-30



31 01-116-31

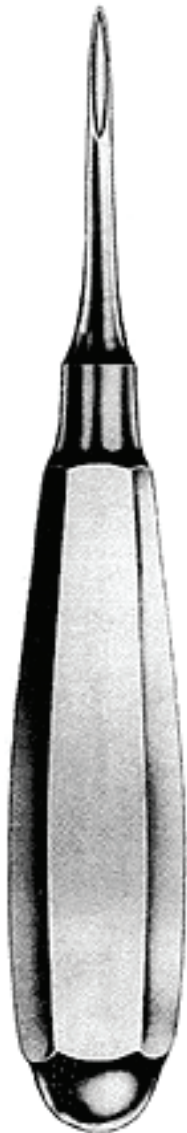

20
01-117-20
Flohr



27
27 Cryer
01-117-27



28
28 Cryer
01-117-28



27S
27S Cryer
01-117-27s



28S
28S Cryer
01-117-28s



29
344
01-117-29



30
345
01-117-30



21
1L Seldin
01-117-21



22
1R Seldin
01-117-22



23
4L Seldin
01-117-23



24
4R Seldin
01-117-24



25
01-117-25



26
01-117-26



31
01-117-31



32
01-117-32



33
Miller 1
01-117-33



34
Miller 2
01-117-34



35
Miller 3
01-117-35



36
Miller 4
01-117-36

ROOT ELEVATORS
WURZELHEBER
ELEVADORES PARA RAICES



01-168-00



1 2
01-168-01 01-168-02



01-169-00



1
01-169-01



2
01-169-02



3
01-169-03



1
01-170-01



2
01-170-02



01-170-00



01-171-00
 Schlemmer
 1-2



1
 01-171-01



2
 01-171-02



01-172-00
 Thomson
 1-6



1
 01-172-01



2
 01-172-02



3
 01-172-03



4
 01-172-04



5
 01-172-05



6
 01-172-06

ROOT ELEVATORS
WURZELHEBER
ELEVADORES PARA RAICES



1
01-223-01
Chompret



2
01-223-02



3
01-223-03



4
01-223-04



1
01-224-01
Heidbrink



2 3
01-224-02 01-224-03
Heidbrink



1
01-225-01



2
01-225-02



3
01-225-03

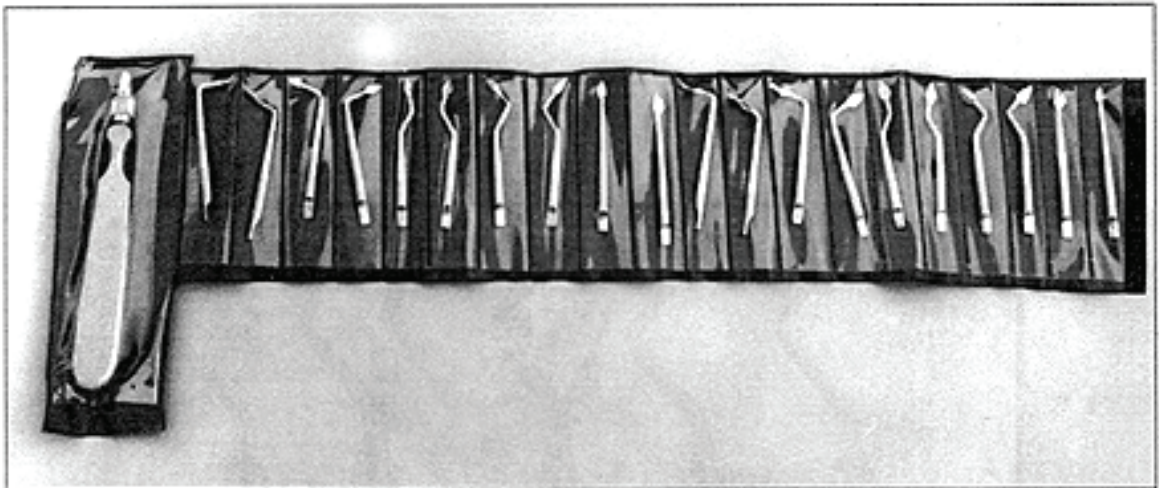

01-226-00
Elevators set with 20 detachable points

ROOT ELEVATORS
WURZELHEBER
ELEVADORES PARA RAICES

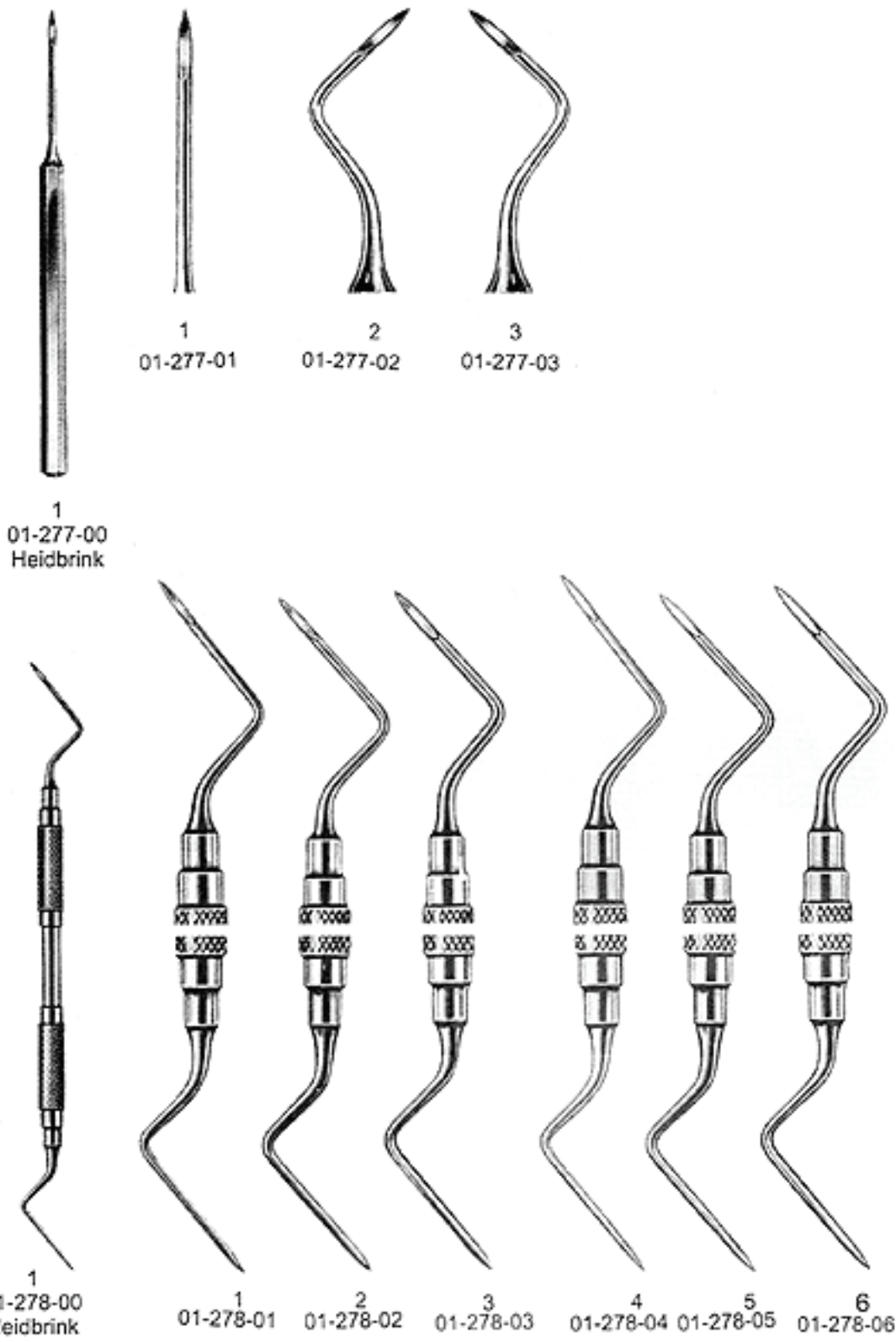

Department

02

TWEEZER
ZHAN PINZETTEN
PINZAS

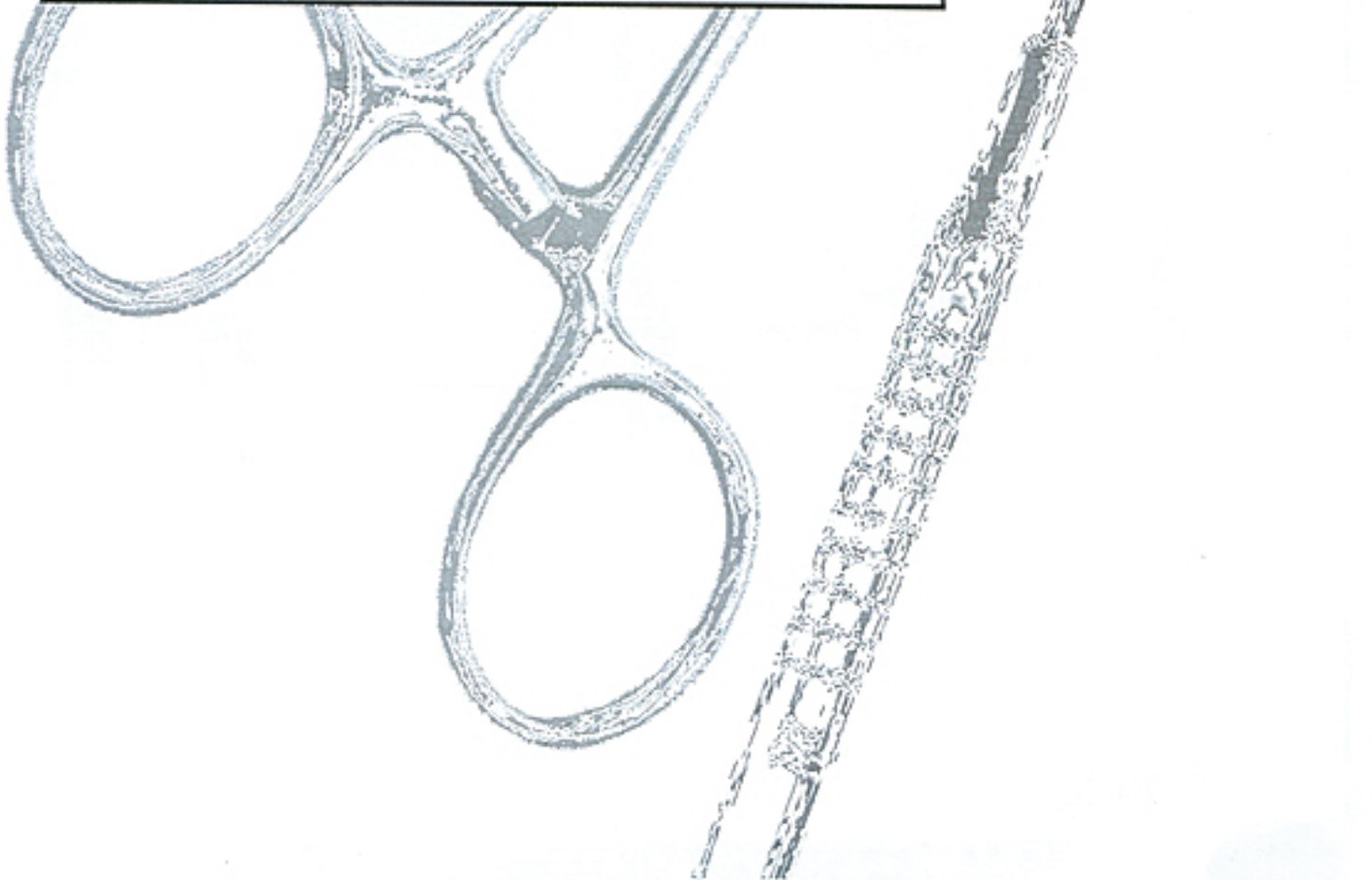
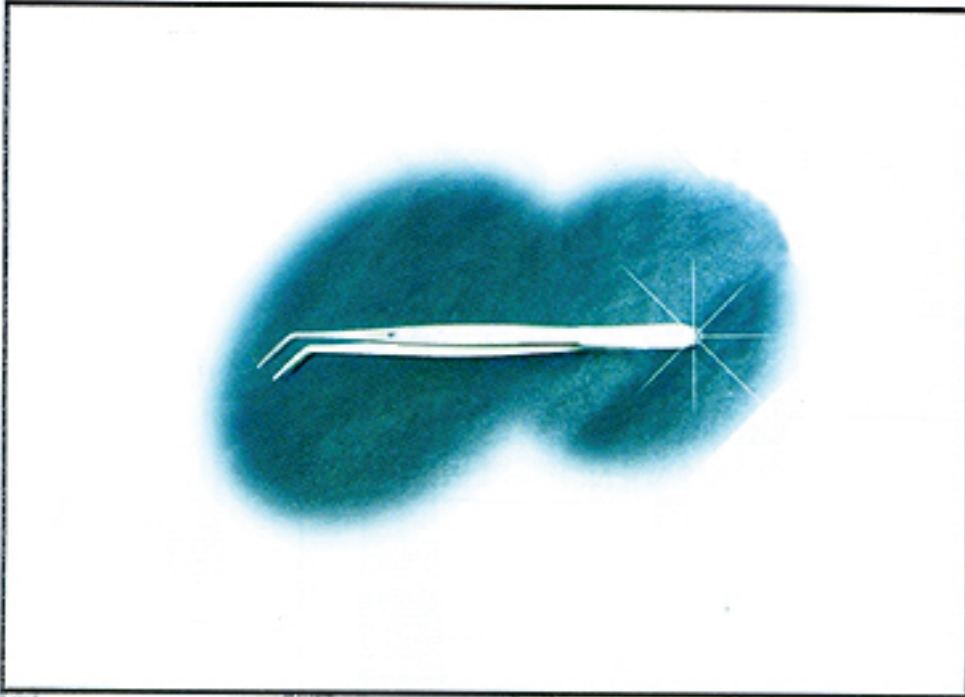

DEPARTMENT NO. 2

FROM
PAGE#

19

TO
PAGE#

38

INSTRUMENTS CATEGORY

DRESSING FORCEPS
INSTRUMENTS ANATOMISCHE PINZETTEN
PINZAS DE DISECCION

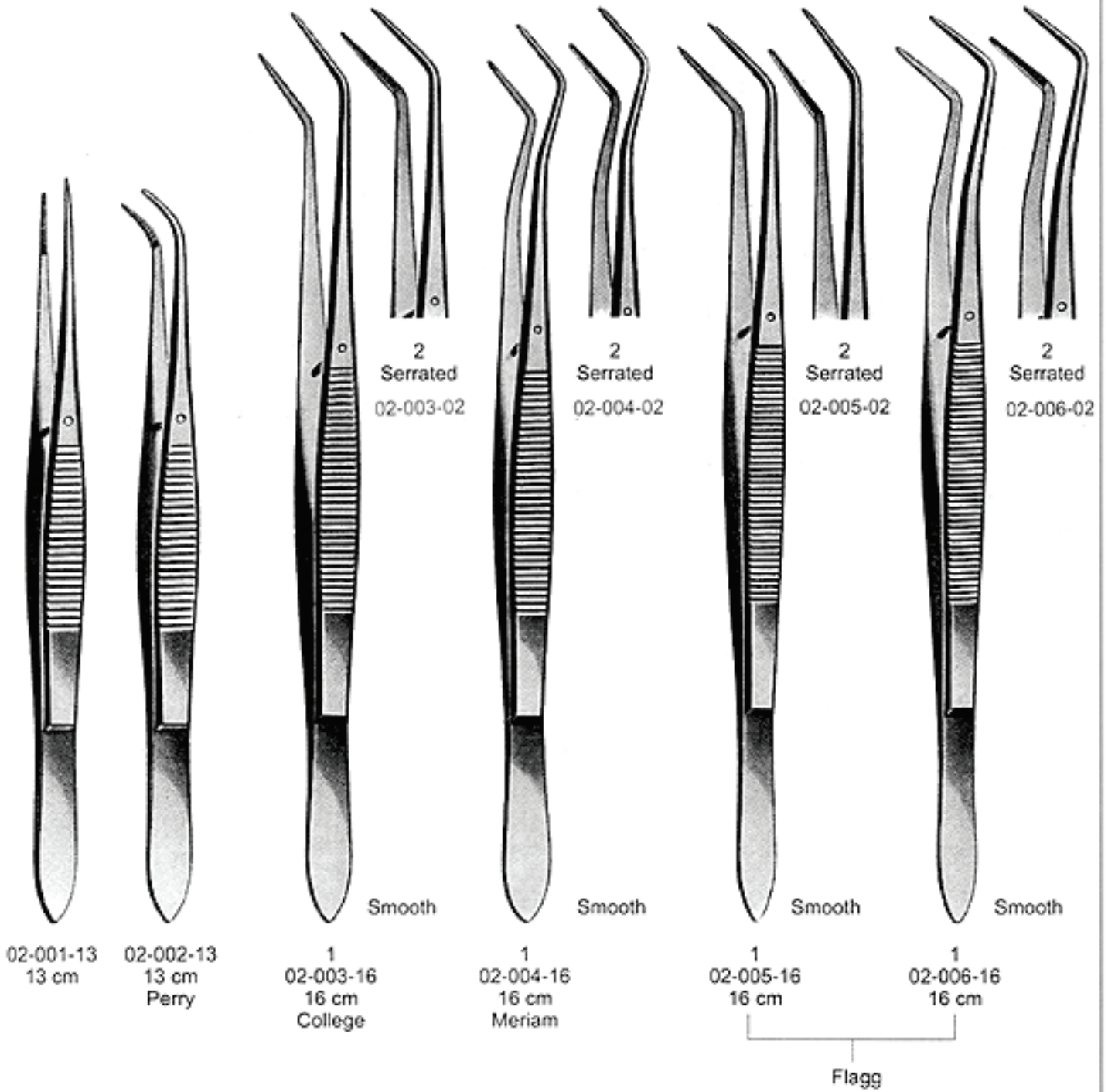
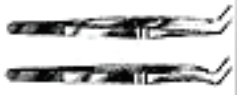

TWEEZERS ZHAN PINZETTEN PINZAS

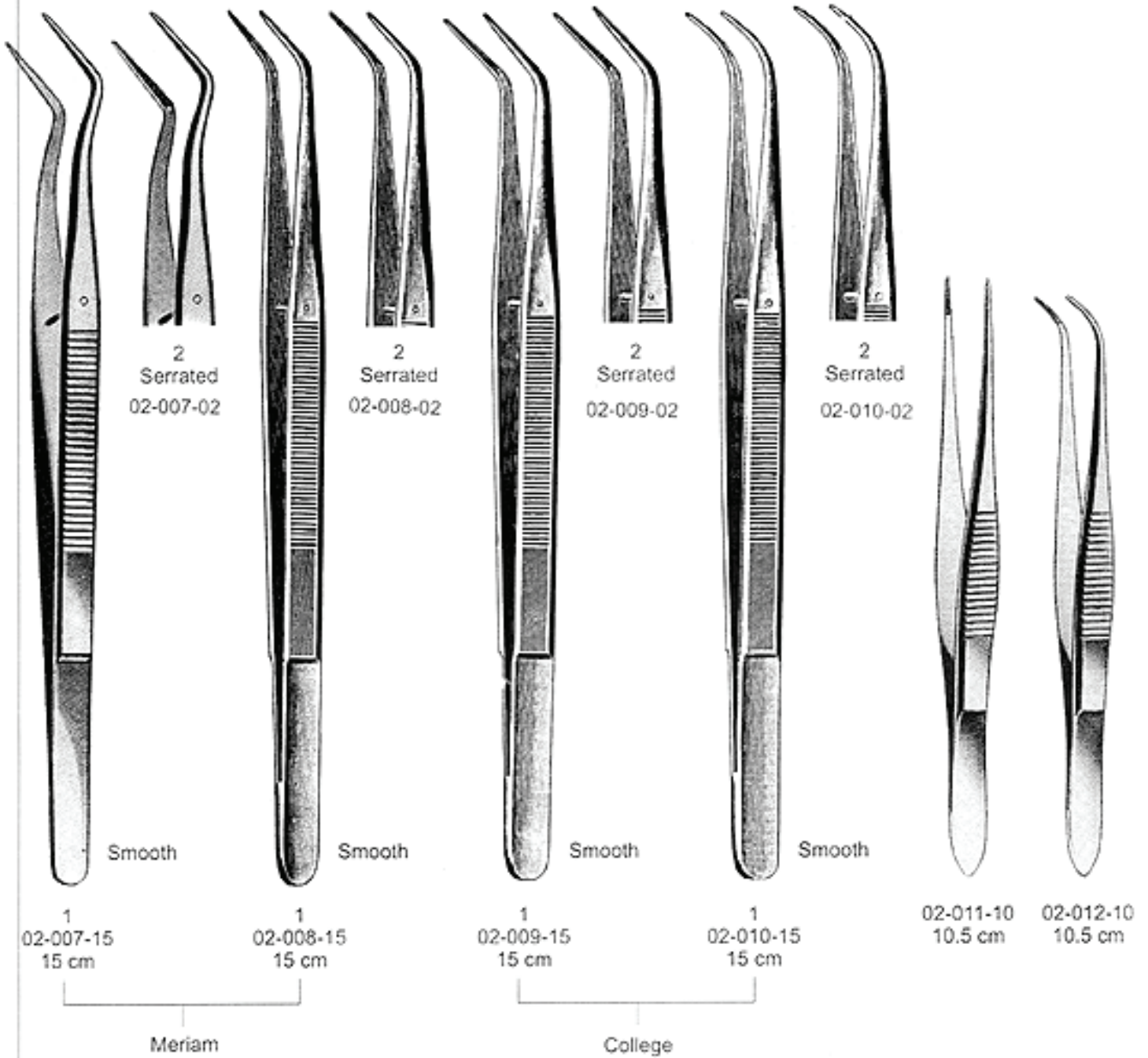

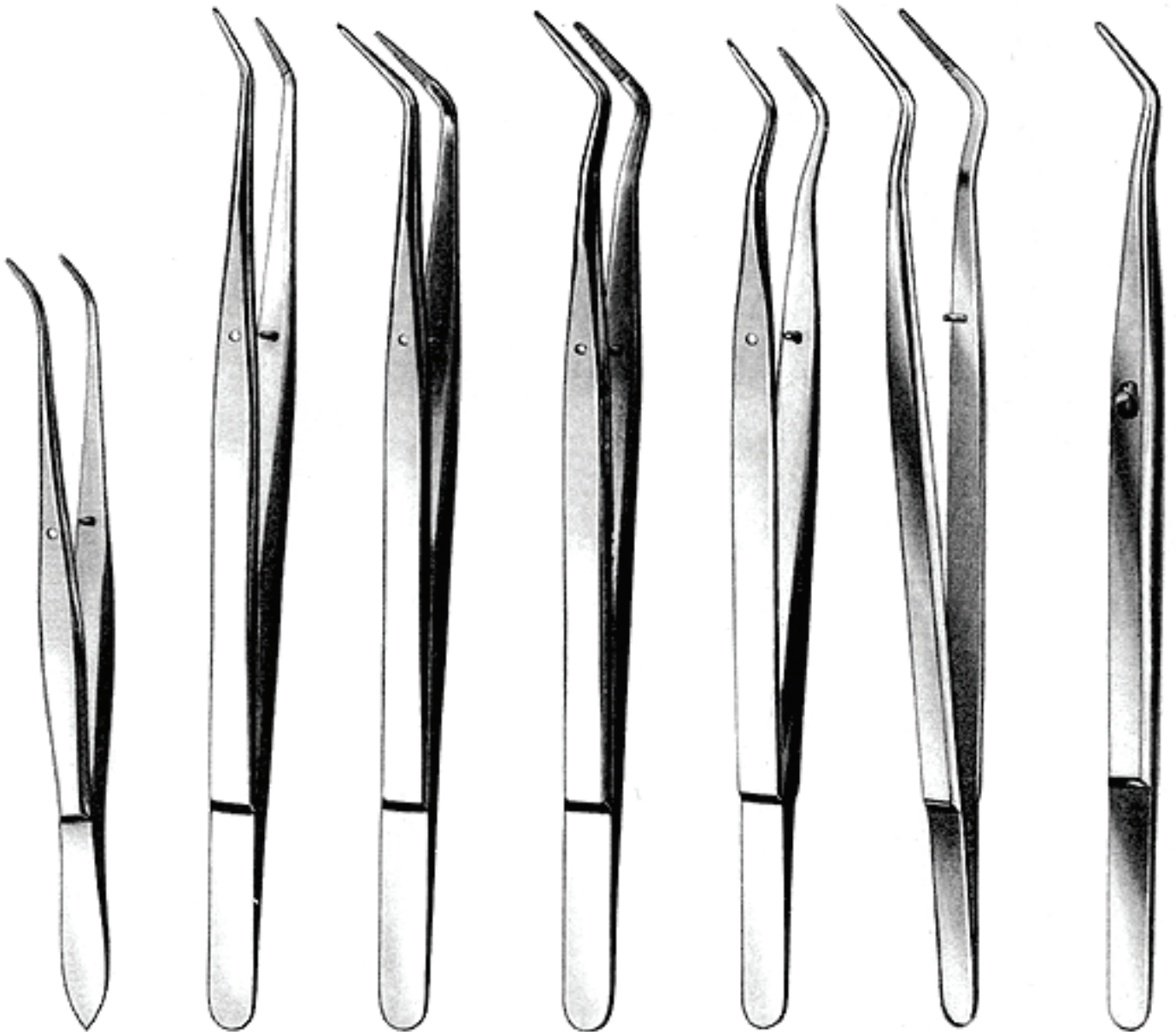

1
02-013-00
Perry

19
02-014-00

18
02-015-00

17
02-016-00

3
02-017-00

2
02-018-00
College

18L
02-019-00

TWEEZERS ZHAN PINZETTEN PINZAS

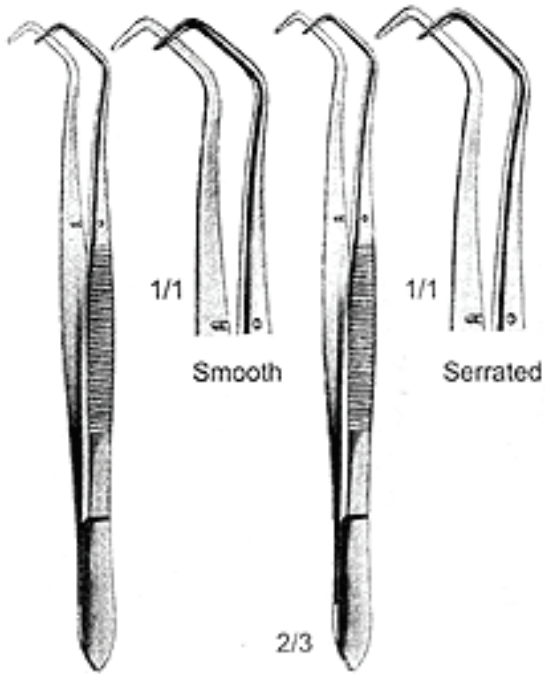

02-020-15
15 cm

02-021-15
15 cm

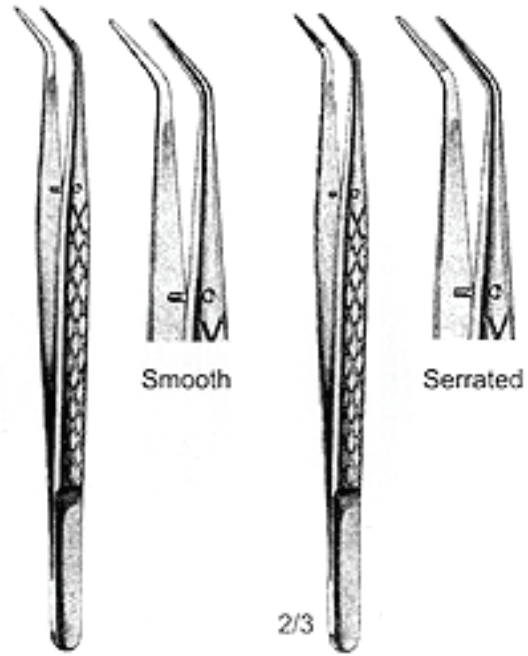

02-022-15
15 cm

02-023-15
15 cm

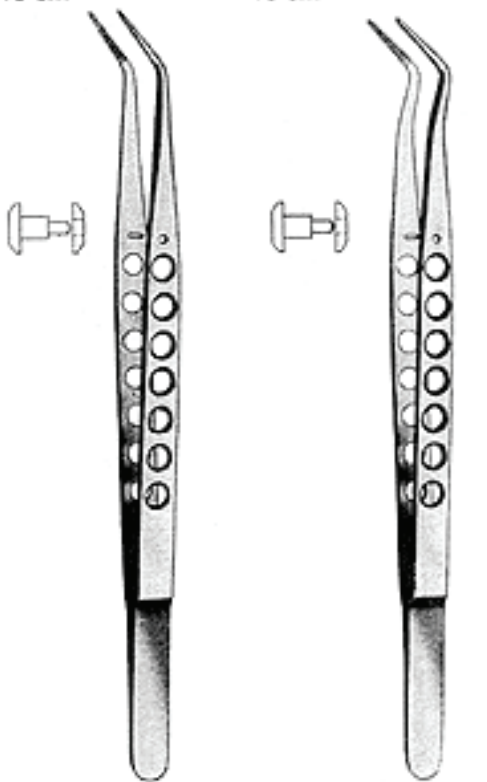

02-024-15
15 cm

02-025-15
15 cm



02-026-15
15 cm

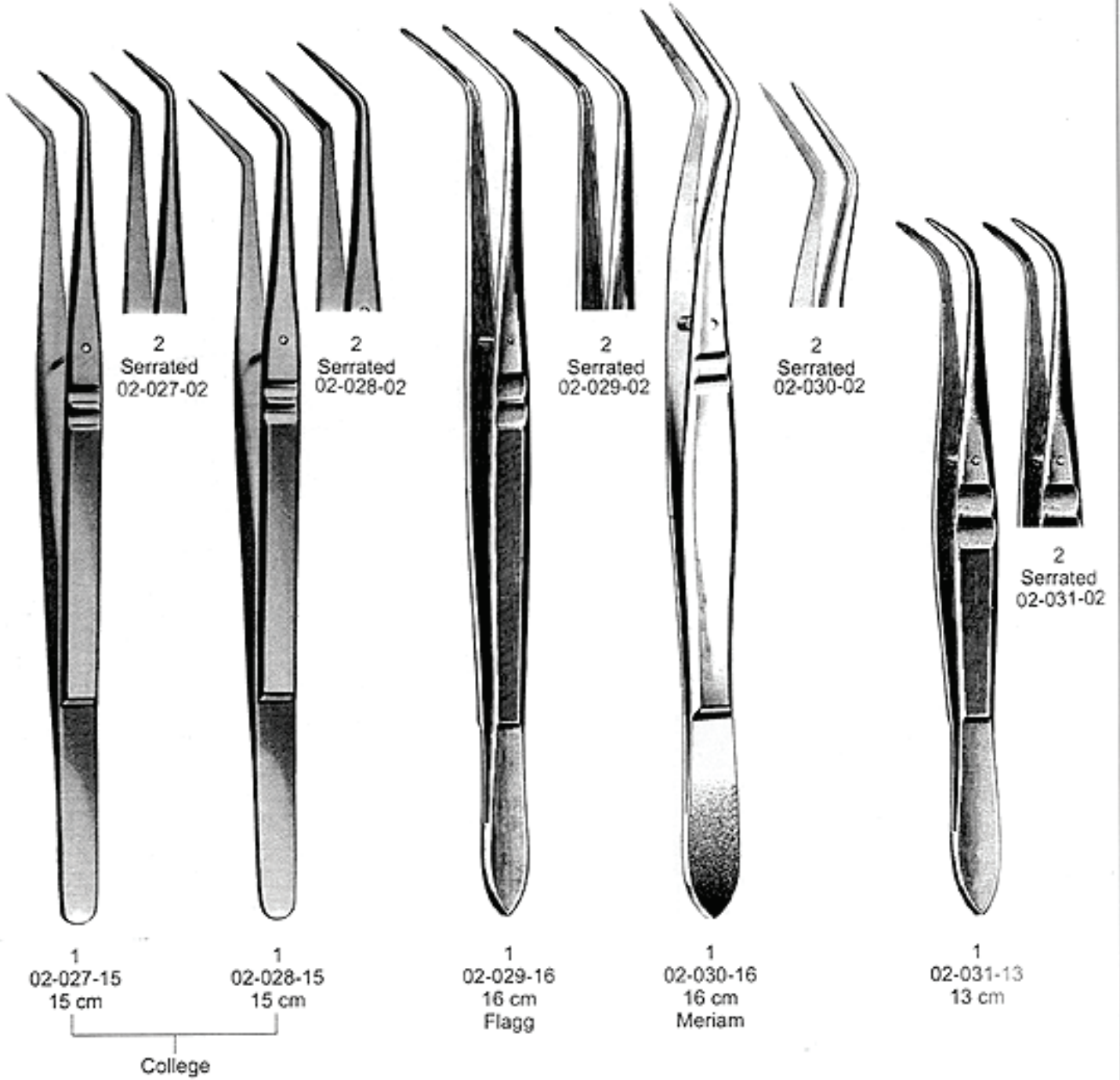

DRESSING AND DISSECTING FORCEPS -
SUTURE TWEEZERS
PINCES A DISSECTION - PINCES DE SUTURE
PINZAS DE DISECCION - PINZAS DE SUTURA

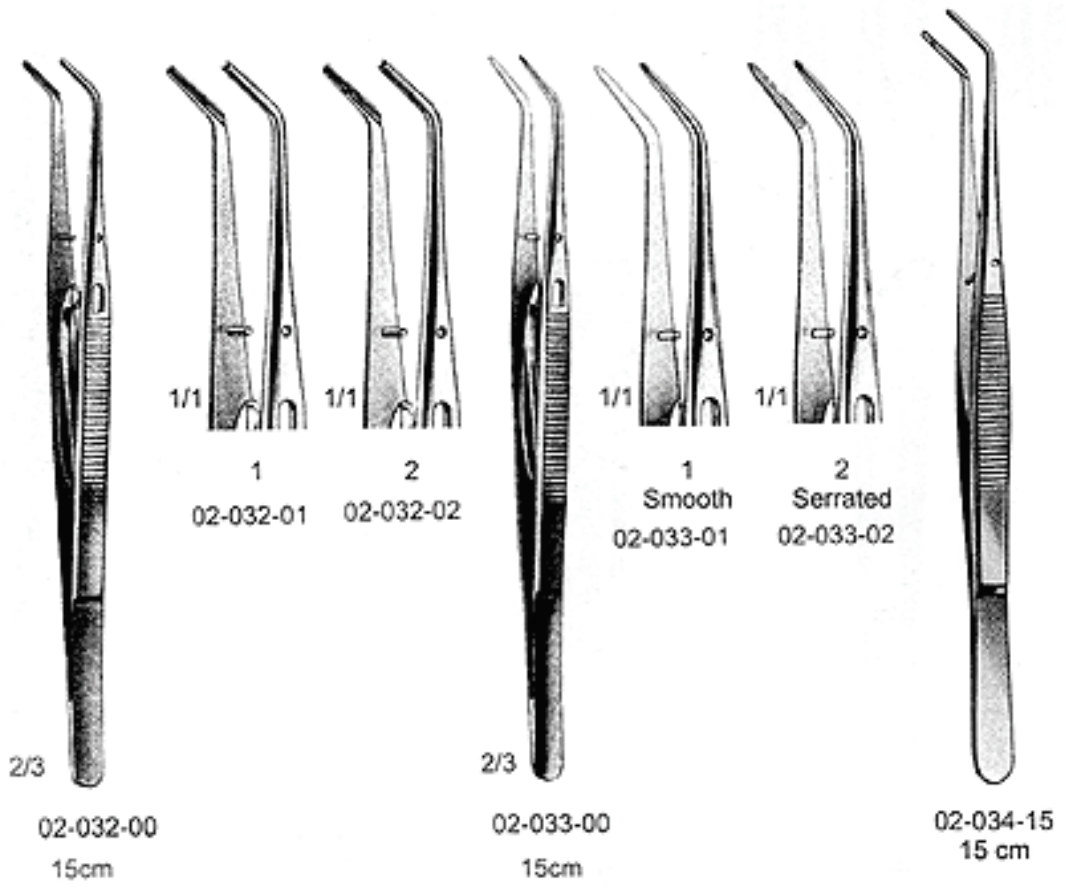

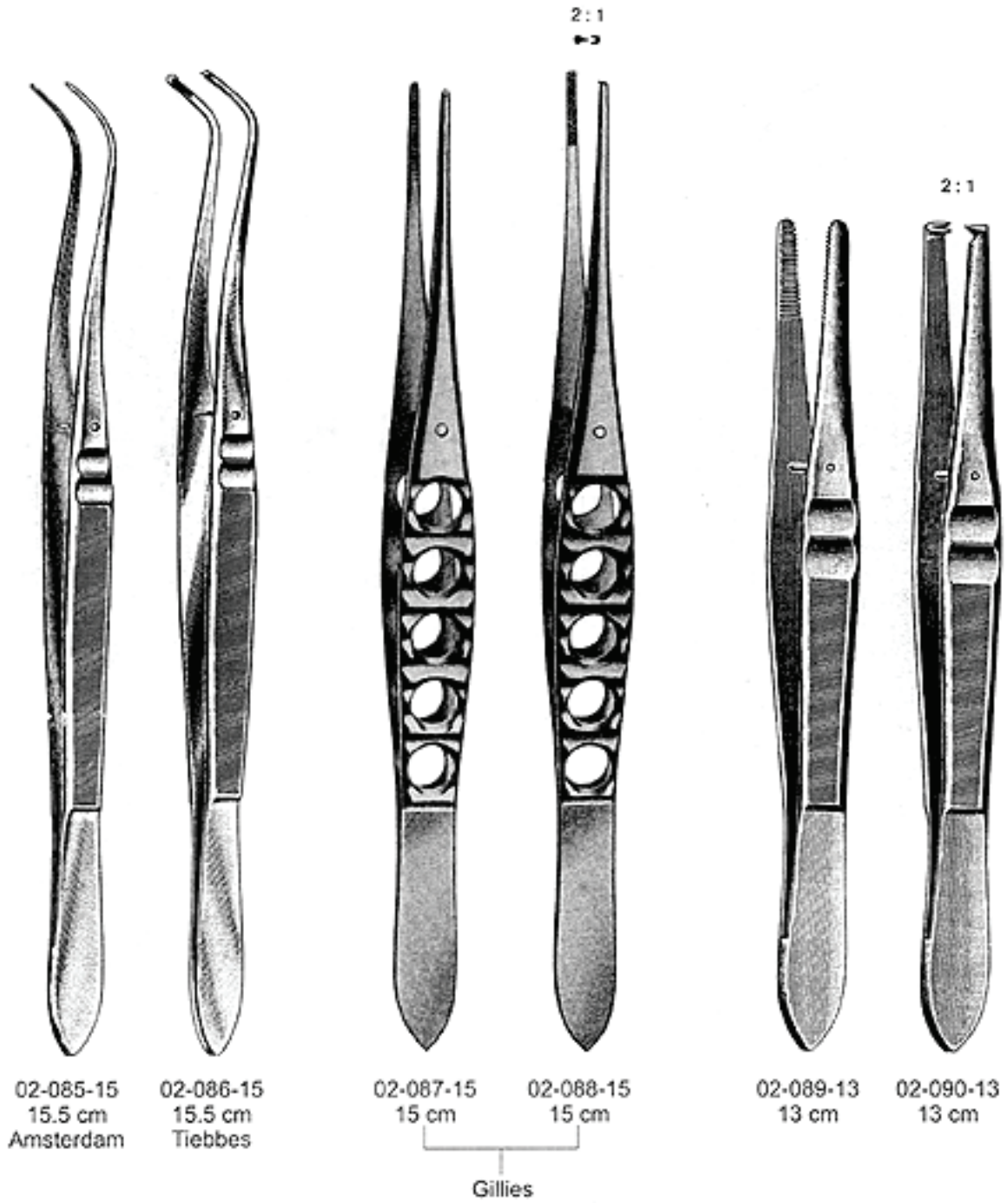



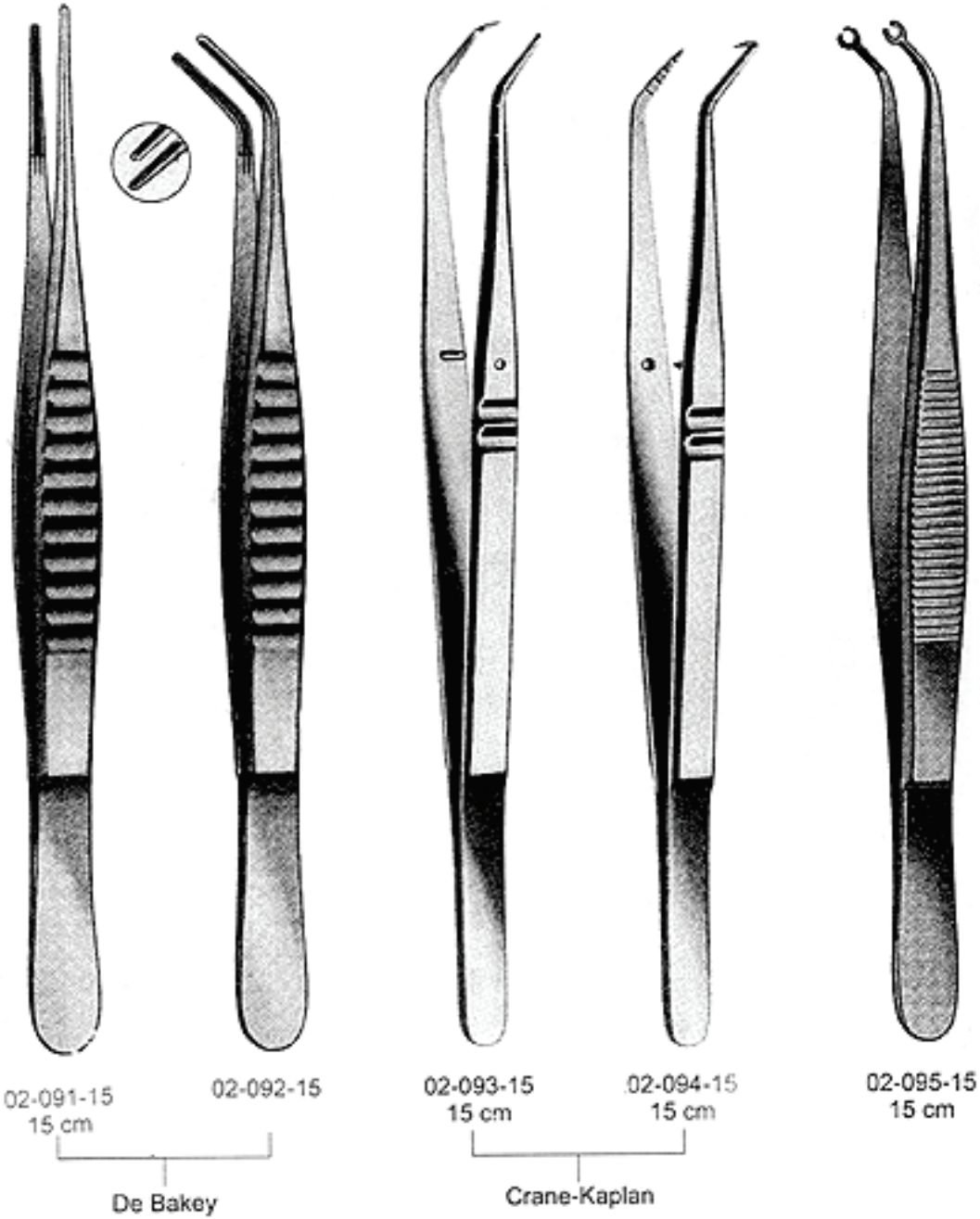





TISSUE FORCEPS
CHIRURGISCHE PINZETTEN
PRECELLES CHIRURGICALES













02-146-00
Standard

							
1 11 cm 02-146-01	2 13 cm 02-146-02	3 14.5 cm 02-146-03	4 16 cm 02-146-04	5 18 cm 02-146-05	6 20 cm 02-146-06	7 25 cm 02-146-07	8 30 cm 02-146-08



02-147-00
Standard

								
1 10.5 cm 02-147-01	2 10.5 cm 02-147-02	3 13 cm 02-147-03	4 14.5 cm 02-147-04	5 16 cm 02-147-05	6 18 cm 02-147-06	7 20 cm 02-147-07	8 25 cm 02-147-08	9 30 cm 02-147-09

DRESSING FORCEPS
 INSTRUMENTS ANATOMISCHE PINZETTEN
 PINZAS DE DISECCION

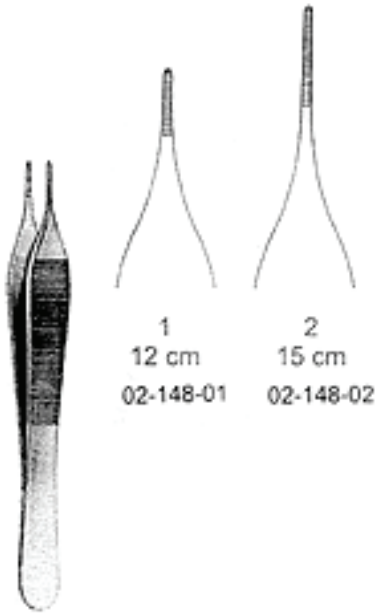

1
12 cm
02-148-01

2
15 cm
02-148-02

02-148-15
Adson



1/1
1

02-149-15
15 cm
McIndoe



02-149-15
Gracile

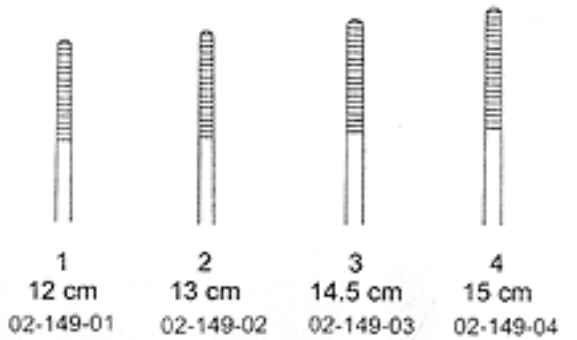

1
12 cm
02-149-01

2
13 cm
02-149-02

3
14.5 cm
02-149-03

4
15 cm
02-149-04



02-151-00
Standard

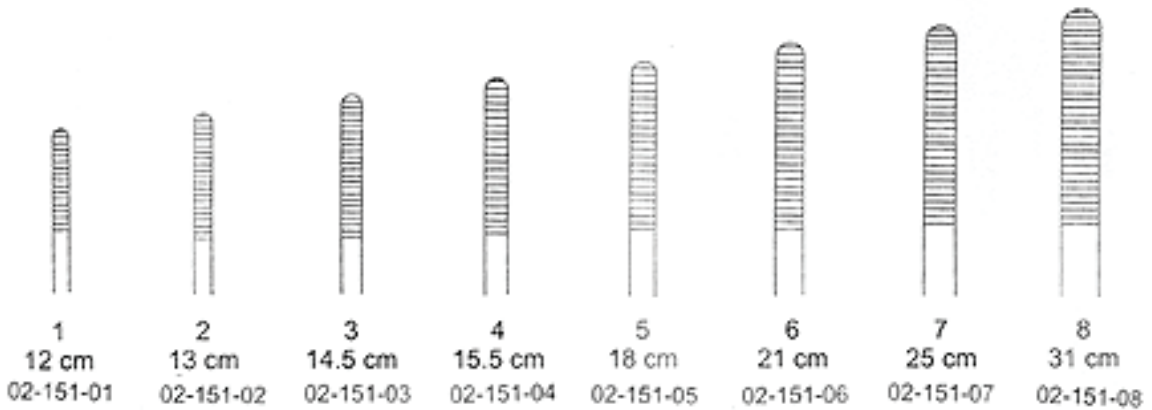

1
12 cm
02-151-01

2
13 cm
02-151-02

3
14.5 cm
02-151-03

4
15.5 cm
02-151-04

5
18 cm
02-151-05

6
21 cm
02-151-06

7
25 cm
02-151-07

8
31 cm
02-151-08



02-152-00
 Mod Martin



02-153-00
 15 cm
 Stille



02-154-00



02-155-00

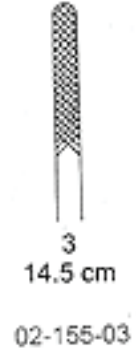
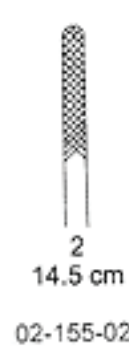
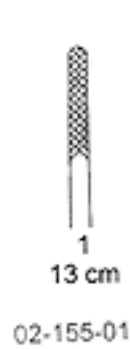

DRESSING FORCEPS
INSTRUMENTS ANATOMISCHE PINZETTEN
PINZAS DE DISECCION



02-156-00
Patts Smith



1
18 cm
02-156-01



2
21 cm
02-156-02



3
25 cm
02-156-03



02-157 -18
18 cm
Gerald



02-157 -18
18 cm



02-158 -18
18 cm



02-159 -17
17.5 cm



02-159 -17
17.5 cm



02-160-17
17.5 cm

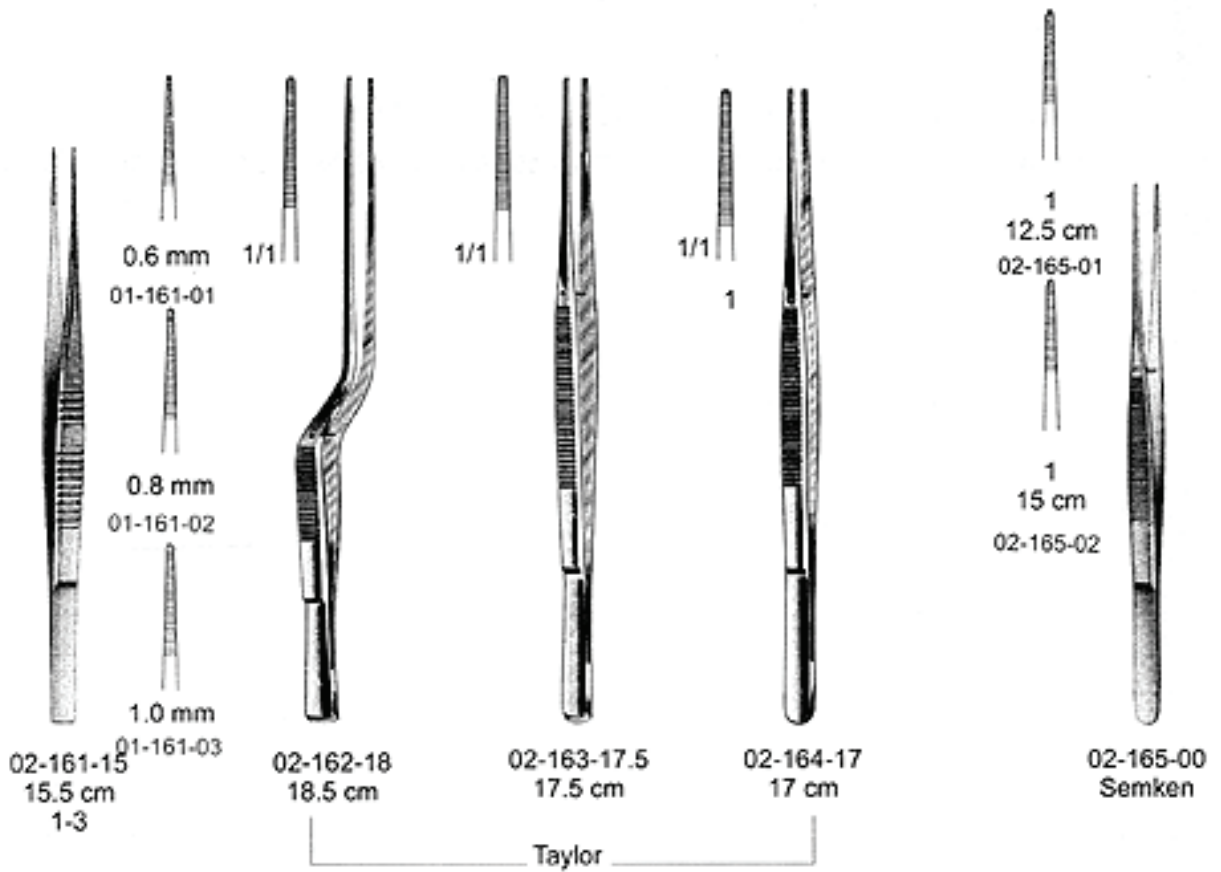

DRESSING FORCEPS
INSTRUMENTS ANATOMISCHE PINZETTEN
PINZAS DE DISECCION

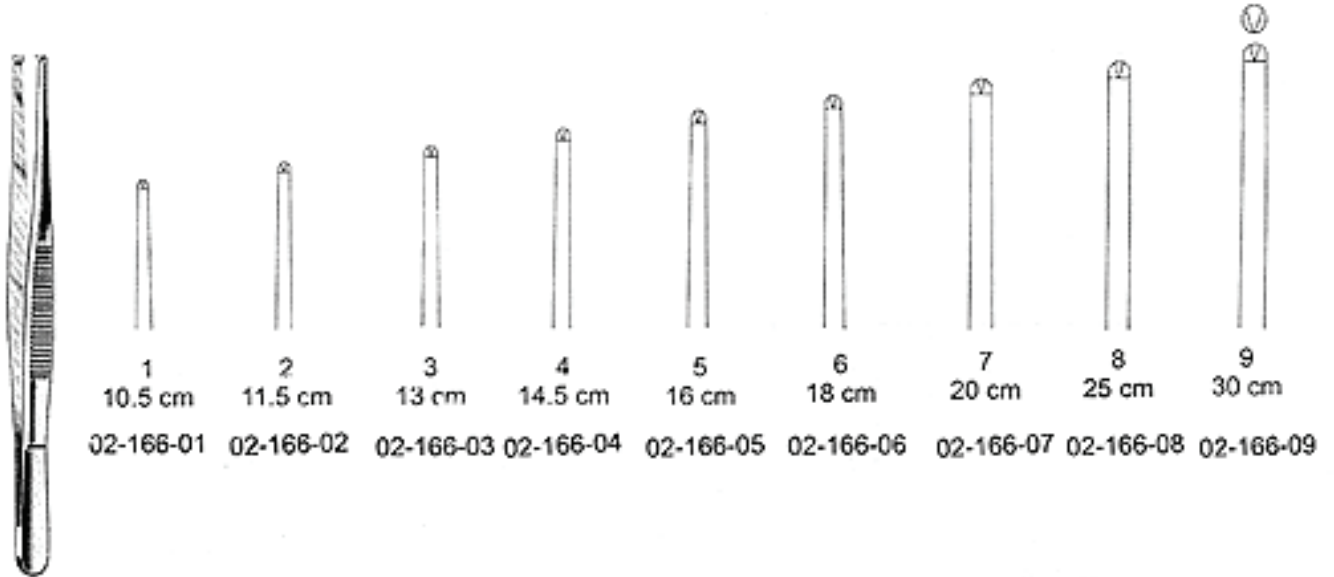

1	2	3	4	5	6	7	8	9
10.5 cm	11.5 cm	13 cm	14.5 cm	16 cm	18 cm	20 cm	25 cm	30 cm
02-166-01	02-166-02	02-166-03	02-166-04	02-166-05	02-166-06	02-166-07	02-166-08	02-166-09

02-166-00
1x2 Teeth



1	2	3	4	5	6	7
11.5 cm	13 cm	14.5 cm	16 cm	18 cm	20 cm	25 cm
02-167-01	02-167-02	02-167-03	02-167-04	02-167-05	02-167-06	02-167-07

02-167-00
2x3 Teeth



02-168-00
 1x2 Teeth
 1-2



1
 13 cm
 02-168-01



2
 14 cm
 02-168-02



02-169-00
 1x2 Teeth
 1-4



1
 13 cm
 02-169-01



2
 14 cm
 02-169-02



3
 16 cm
 02-169-03



4
 20 cm
 02-169-04



02-170-00
 4x5 Teeth
 1-3



1
 13 cm
 02-170-01



2
 14.5 cm
 02-170-02



3
 16 cm
 02-170-03



02-171-00
 3x4 Teeth
 1-3



1
 13 cm
 02-171-01



2
 14.5 cm
 02-171-02



3
 16 cm
 02-171-03

DRESSING FORCEPS
 INSTRUMENTS ANATOMISCHE PINZETTEN
 PINZAS DE DISECCION

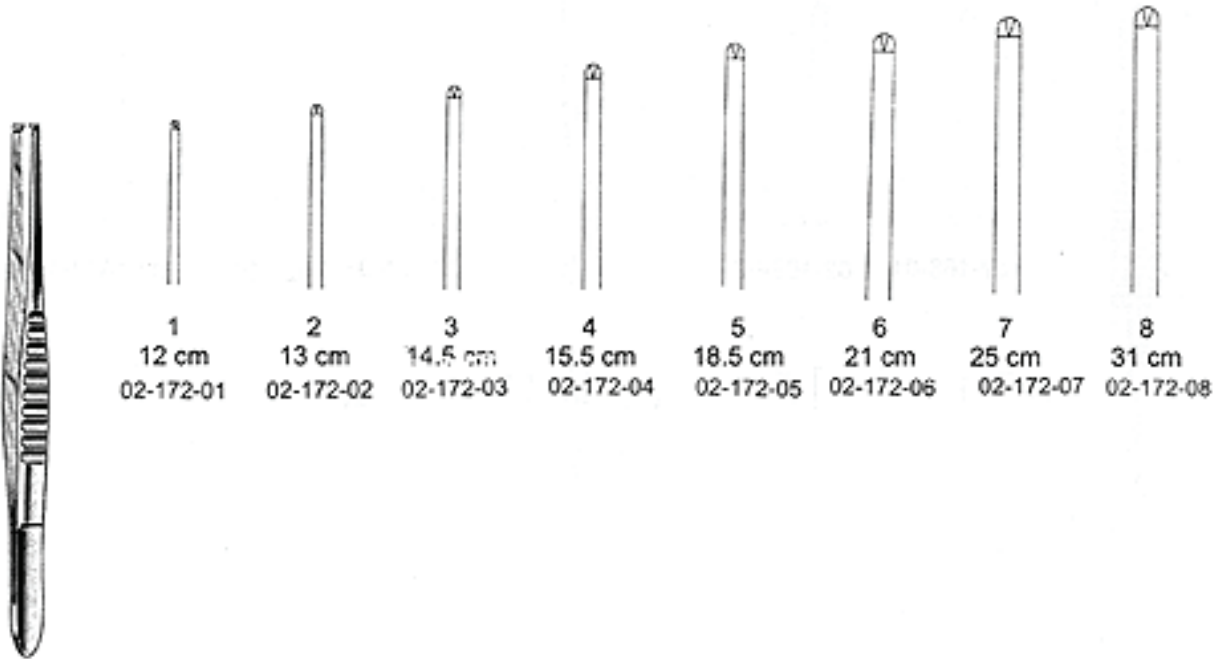

1	2	3	4	5	6	7	8
12 cm	13 cm	14.5 cm	15.5 cm	18.5 cm	21 cm	25 cm	31 cm
02-172-01	02-172-02	02-172-03	02-172-04	02-172-05	02-172-06	02-172-07	02-172-08

02-172-00
 Mod U.S.A
 1-8

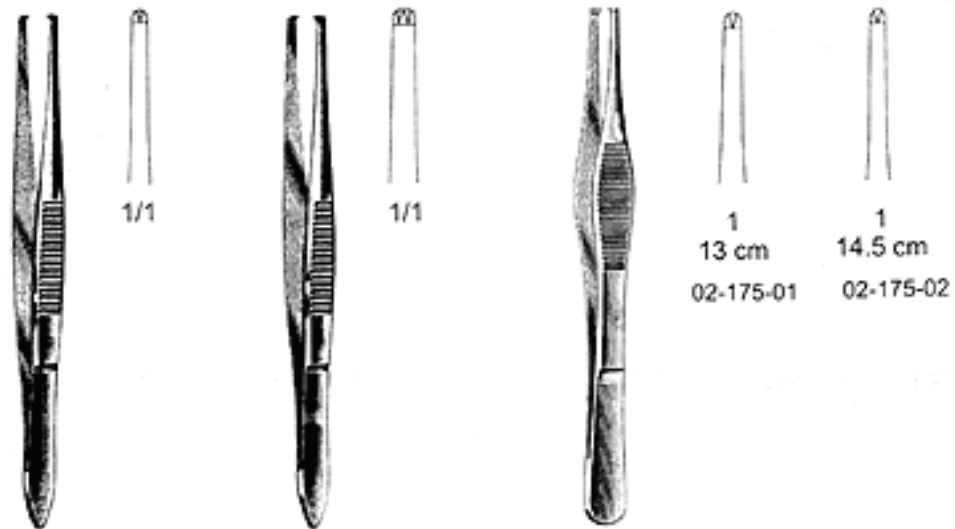

02-173-15
 15 cm
 Stille
 1x2 Teeth

02-174-15
 15 cm
 Stille
 2x3 Teeth

02-175-00
 Mod-Martin
 1x2 Teeth

1	1
13 cm	14.5 cm
02-175-01	02-175-02



02-176-08
8 cm



02-177-09
9 cm



02-178-08
8 cm
Feilchenfeld



02-179-10
10.5 cm



02-180-10
10.5 cm

Hunter



**TUNGSTEN
CARBIDE
INSERTS**



02-231-12
12 cm
Adson

02-232-12 02-232-15
12 cm 15 cm
Semken

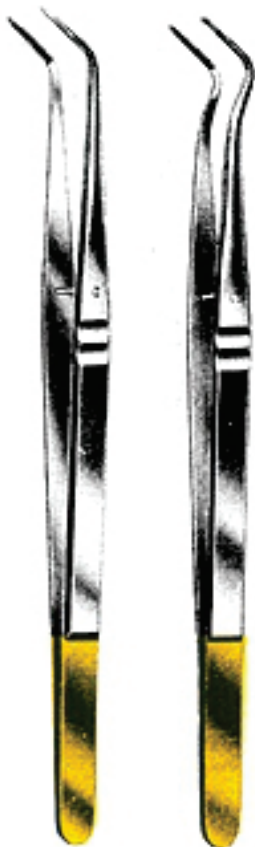

02-233-15 02-234-15
15 cm 15 cm
College Meriam



02-235-15
15 cm
Potts-Smith



02-236-15
15 cm
Standard



02-237-15
15 cm
Meriam



02-238-15
15 cm
Cushing

Department

03

PERIOSTEAL ELEVATORS
RASPATORIEN UND ELEVATORIEN
PERIOSTOTOMOS

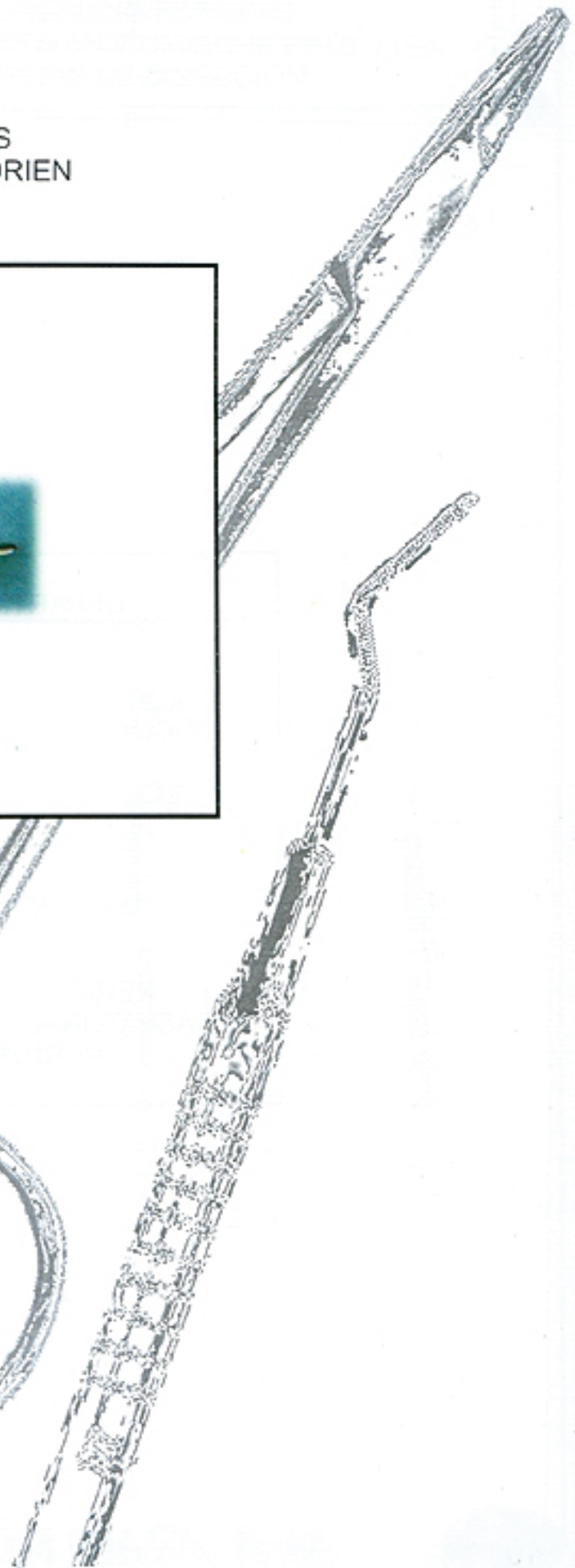
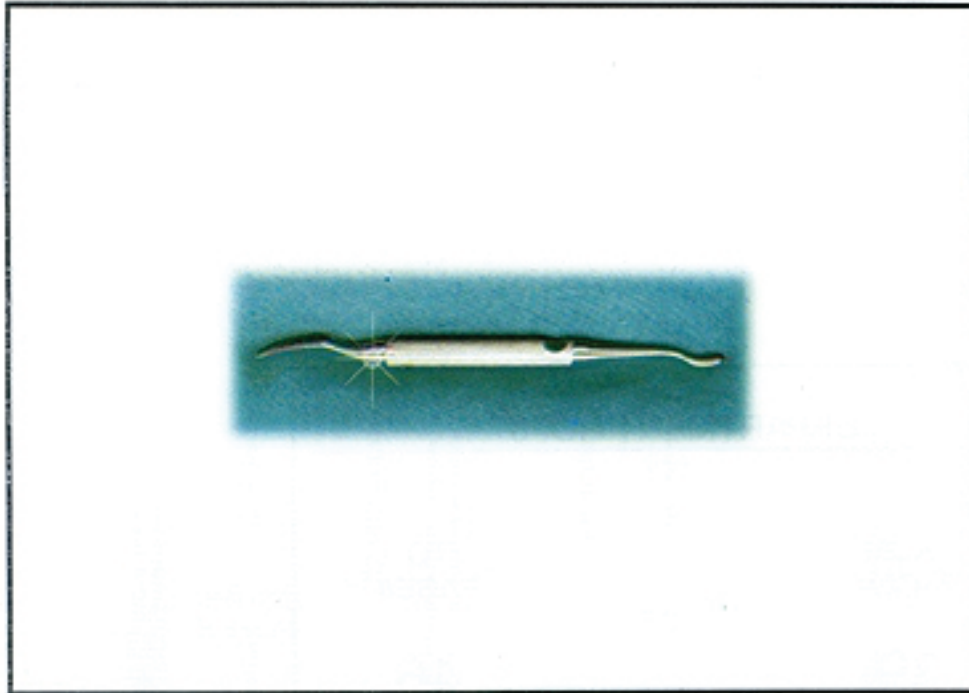

DEPARTMENT NO. 3

FROM
PAGE#

39

TO
PAGE#

46

INSTRUMENTS CATEGORY

PERIOSTEAL ELEVATORS
RASPATORIEN UND ELEVATORIEN
PERIOSTOTOMOS



PERIOSTEAL ELEVATORS
 RASPATORIEN UND ELEVATORIEN
 PERIOSTOTOMOS



03-001-17
 17 cm
 Kandzia



03-002-18.5
 18.5 cm
 Freer

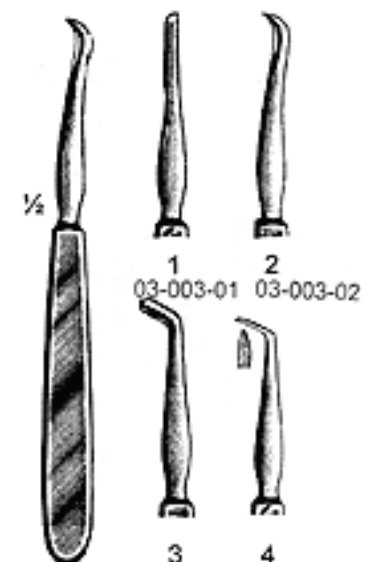

03-003-15
 15 cm
 Chompret

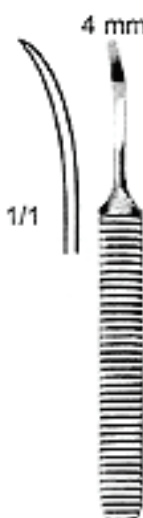

03-004-14
 14 cm



03-005-17
 17.5 cm



03-006-16
 16.5 cm



03-007-16
 16 cm

Willinger

PERIOSTEAL ELEVATORS
RASPATORIEN UND ELEVATORIEN
PERIOSTOTOMOS

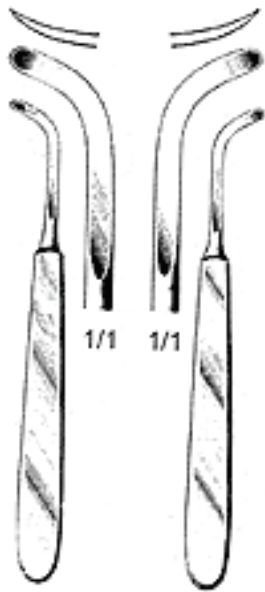

03-008-14
14 cm
Left

03-009-14
14 cm
Right

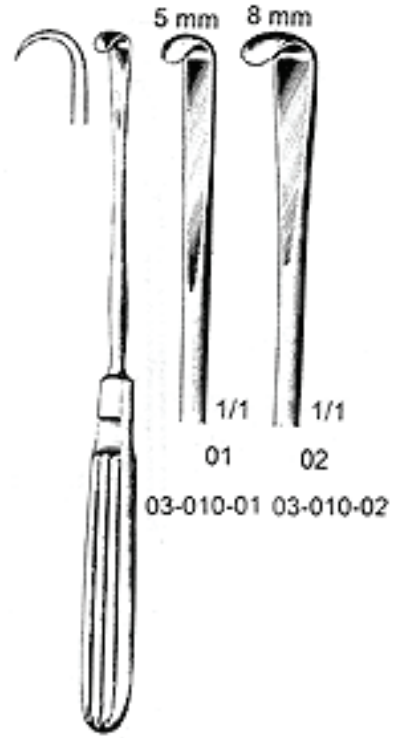

03-010-20
20 cm



03-011-18
18.5 cm
Freer-Yasargil



03-012-20
20 cm
Sewall



03-013-14
14 cm
Trolet



03-014-18
 18 cm
 Molt



03-015-16
 16.5 cm
 Mead



03-016-16
 16 cm
 Freer

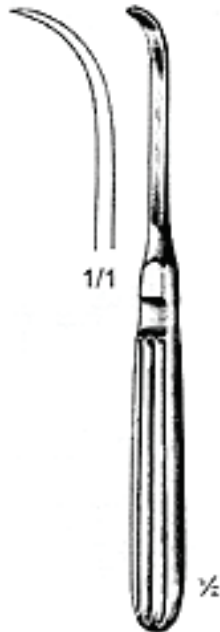

03-017-17
 03-018-17 (6mm)
 17 cm



03-019-16
 16 cm
 Joseph



03-020-17
 17 cm

CHISELS AND GOUGES
BURINS ET GOUGES
CINCELES Y GUBIAS

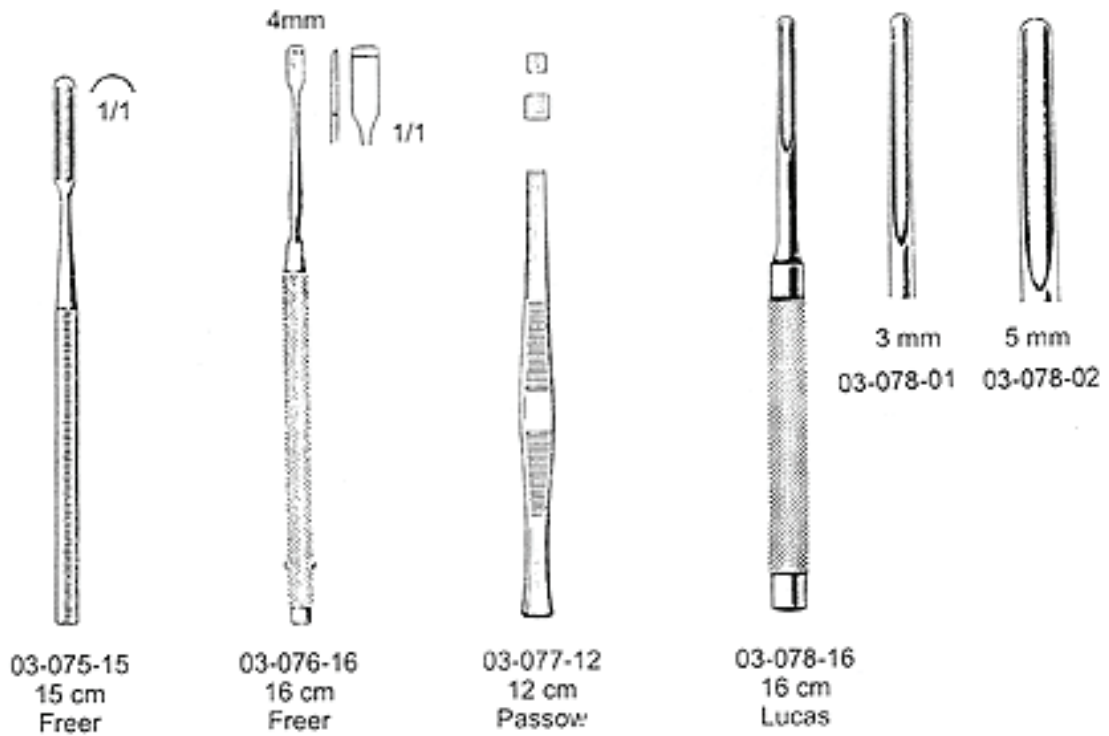
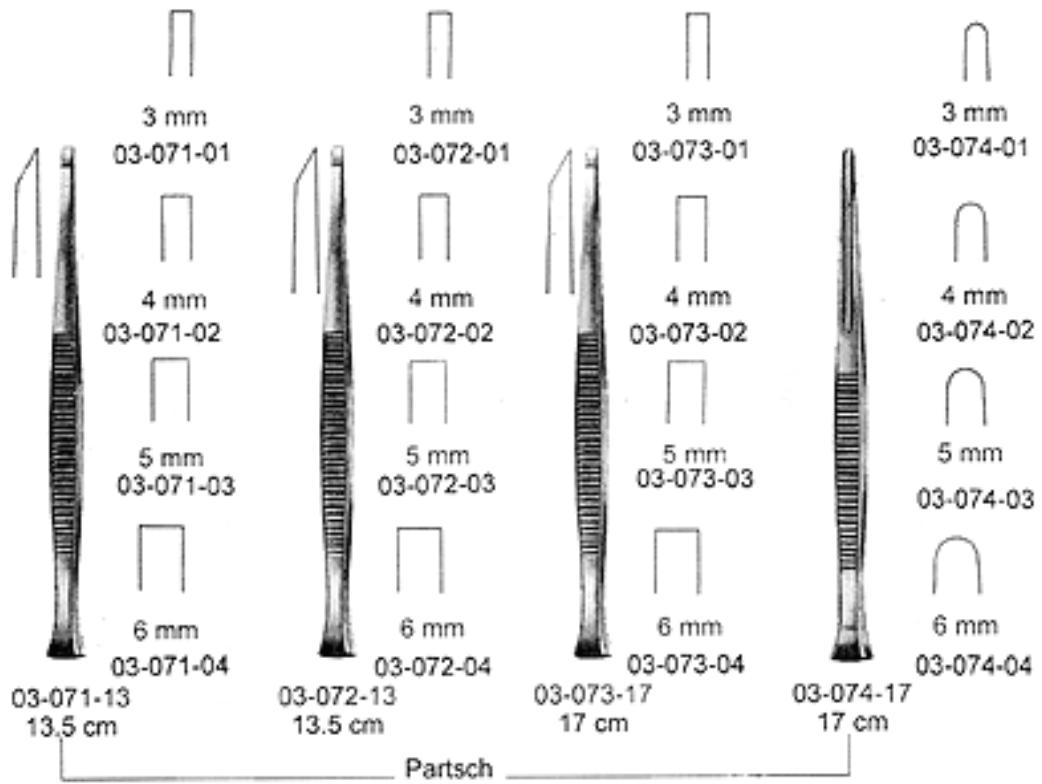

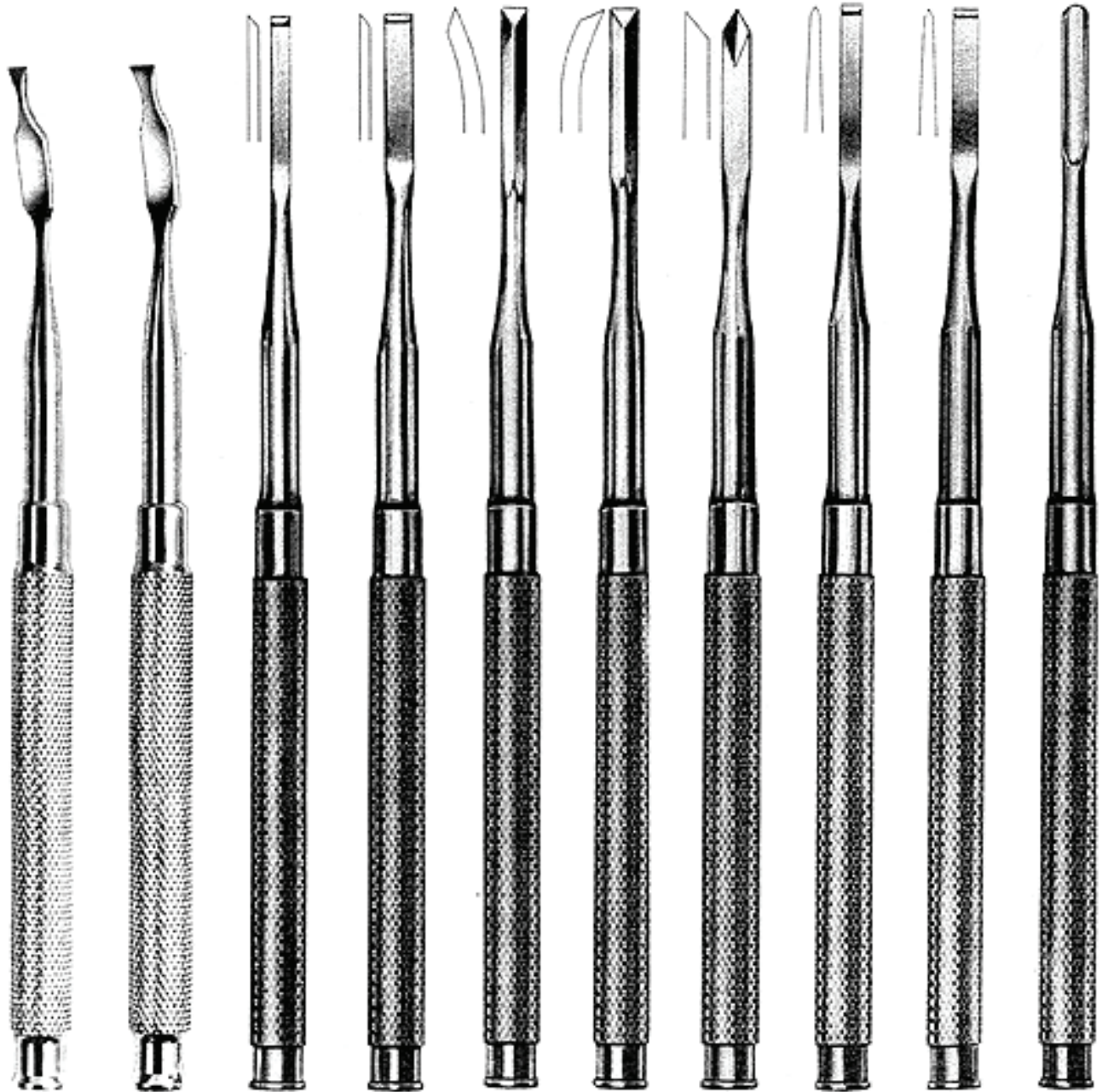

03-079-00 03-080-00 03-081-00 03-082-00 03-083-00 03-084-00 03-085-00 03-086-00 03-087-00 03-088-00
 [Ochsenbein] Gardner [Waketield] Buckley

BONE FILES
LIMES A OS
LIMAS PARA HUESOS



03-139-00
Miller-Colburn

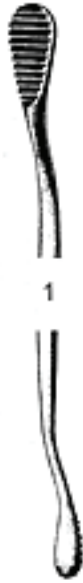

03-139-01



03-139-02

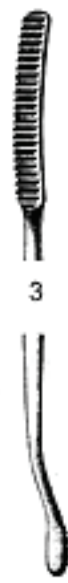

03-139-03

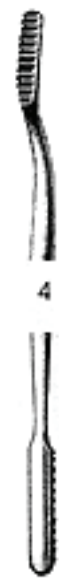

03-139-04



03-140-00

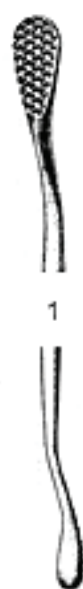

03-140-01

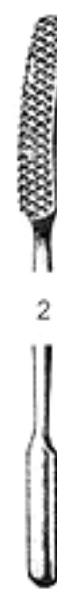

03-140-02

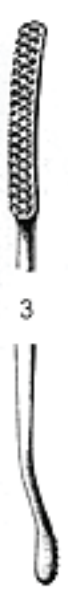

03-140-03

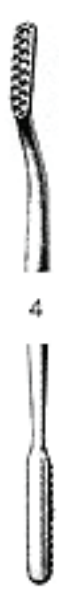

03-140-04

Department

04

EXTRACTING FORCEP, ENGLISH PATTERN
ZAHNANGEN, ENGLISCHE FORM
FORCEPS DE EXTRACCION, FORMA EGGLESA

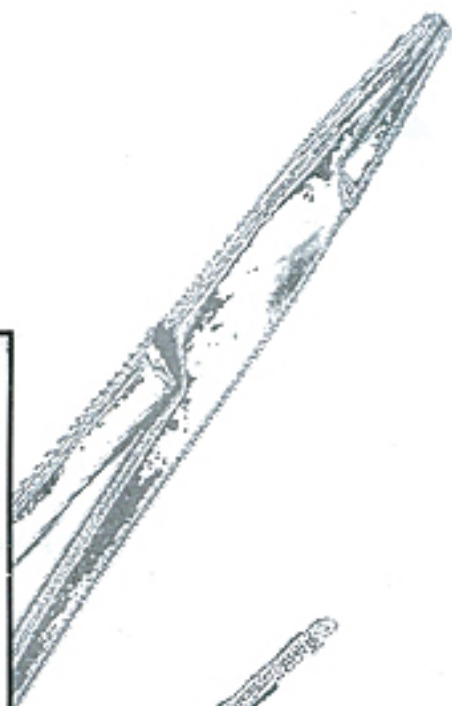
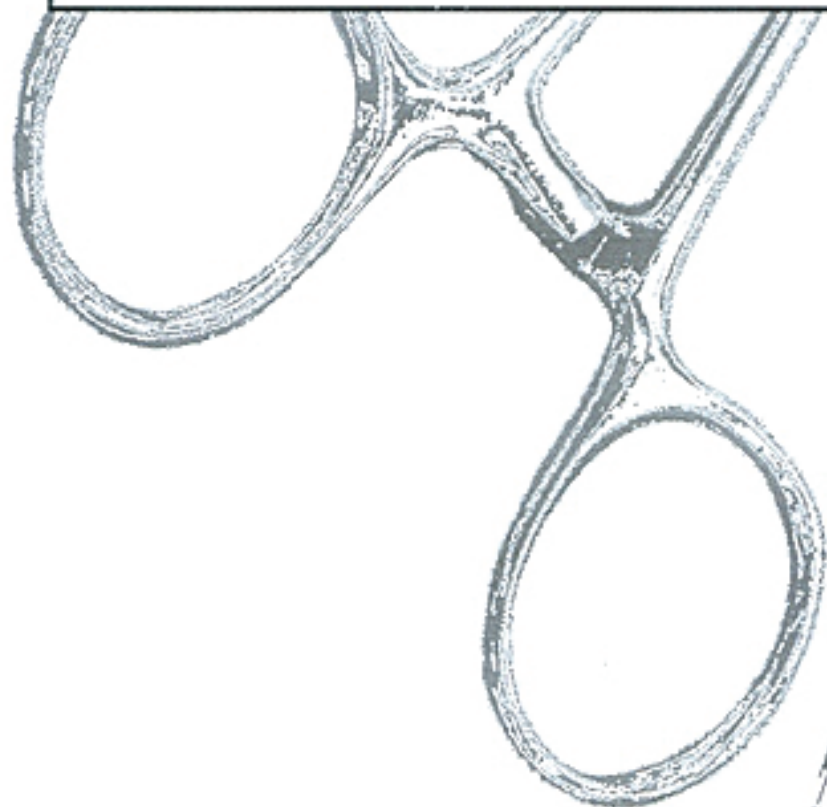

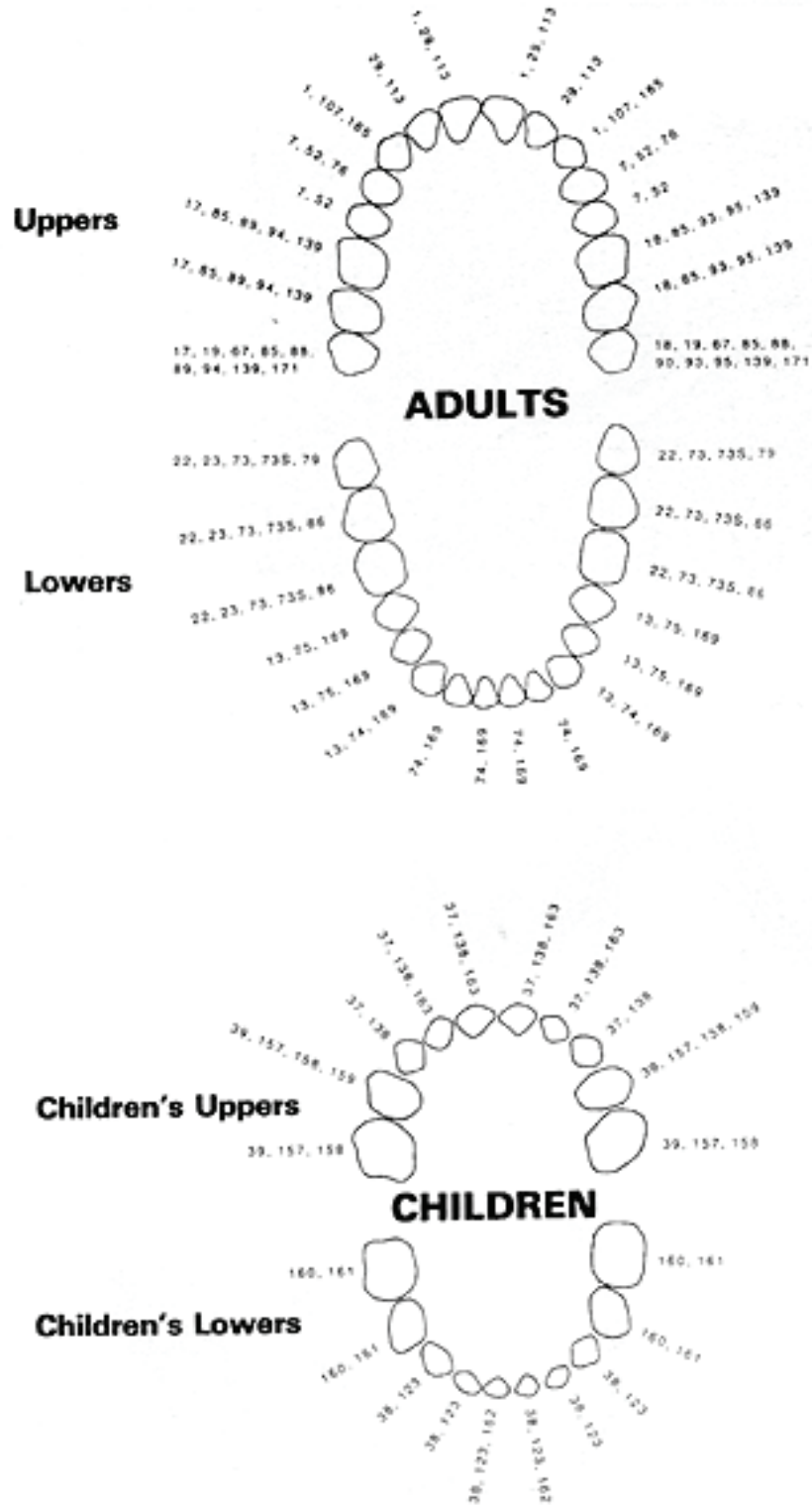

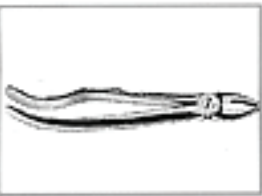

1
04-001-00



2
04-002-00



2 B
04-003-00



7
04-004-00



27
04-005-00



27 B
04-006-00



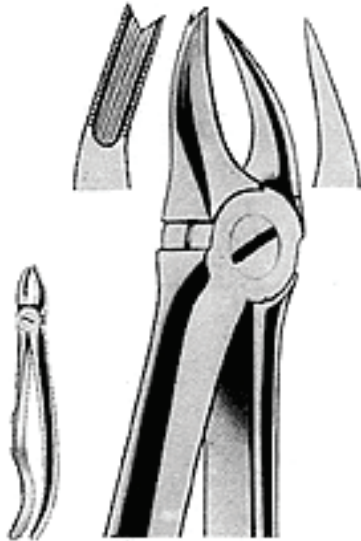
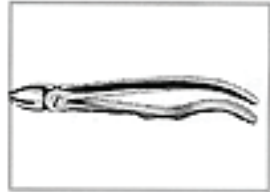

66 R
04-007-00

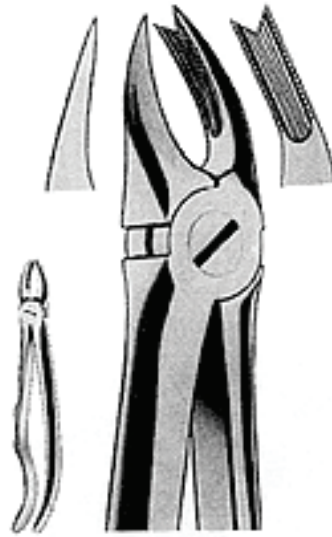

66 L
04-008-00

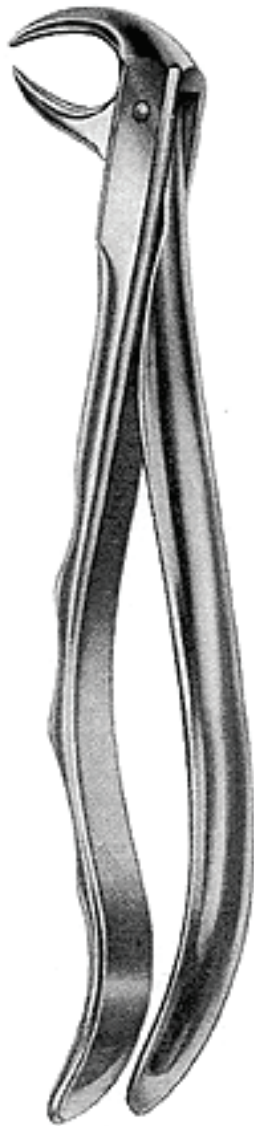

86
04-010-00

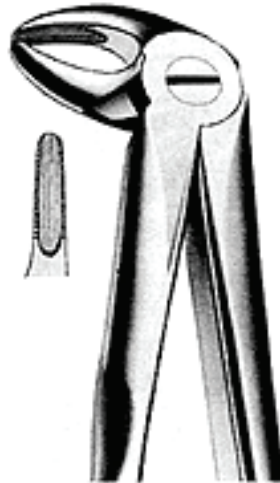

13
04-011-00

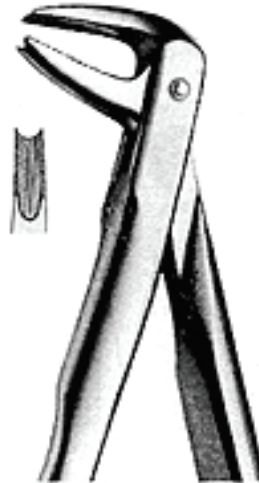

28
04-012-00



23 B
04-013-00

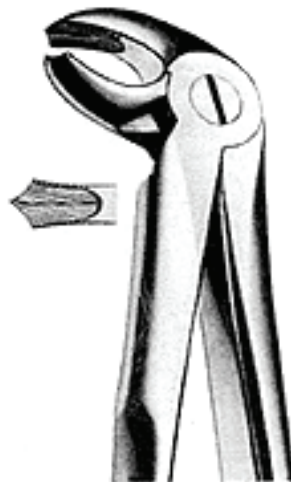

22
04-014-00



78
04-015-00

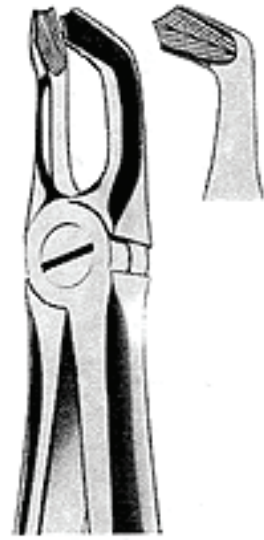

79
04-016-00

EXTRACTING FORCEPS, ENGLISH PATTERN
ZAHNZANGEN, ENGLISCHE FORM
FORCEPS DE EXTRACCION, FORMA ENGLESA



97
04-017-00



59
04-018-00



74
04-019-00

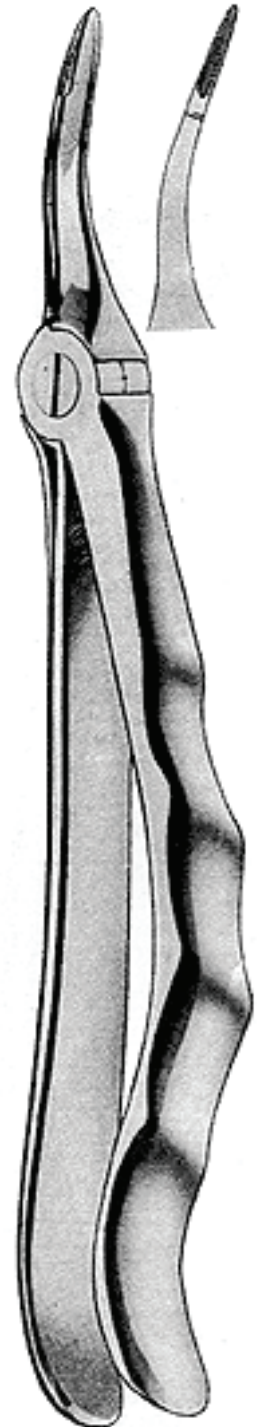

49
04-023-00

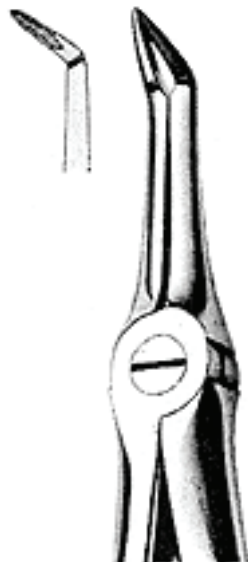

46
04-020-00



33
04-021-00



33 A
04-022-00



1
04-024-00

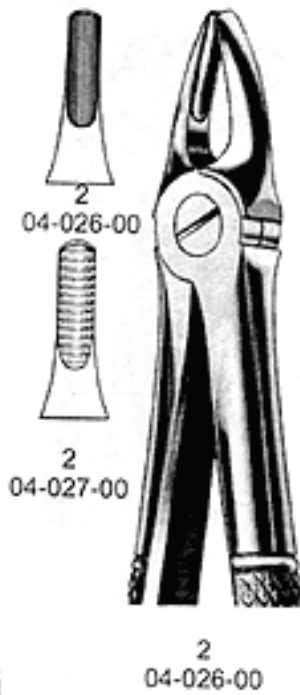

2
04-026-00



3
04-028-00

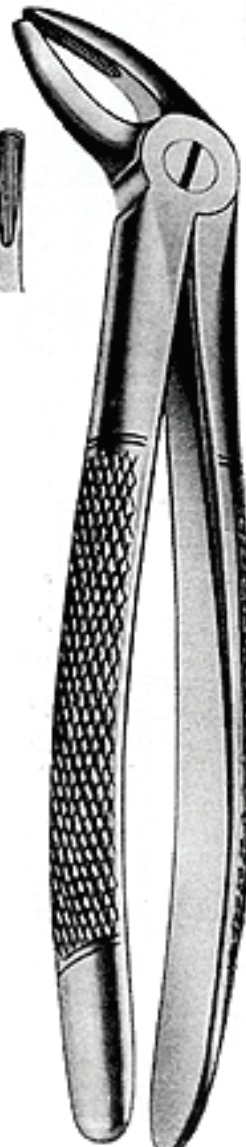

4
04-029-00

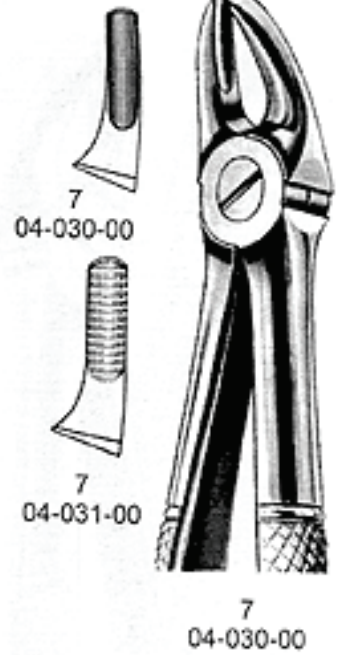

7
04-030-00



8
04-032-00

EXTRACTING FORCEPS, ENGLISH PATTERN
ZAHNZANGEN, ENGLISCHE FORM
FORCEPS DE EXTRACCION, FORMA ENGLESA

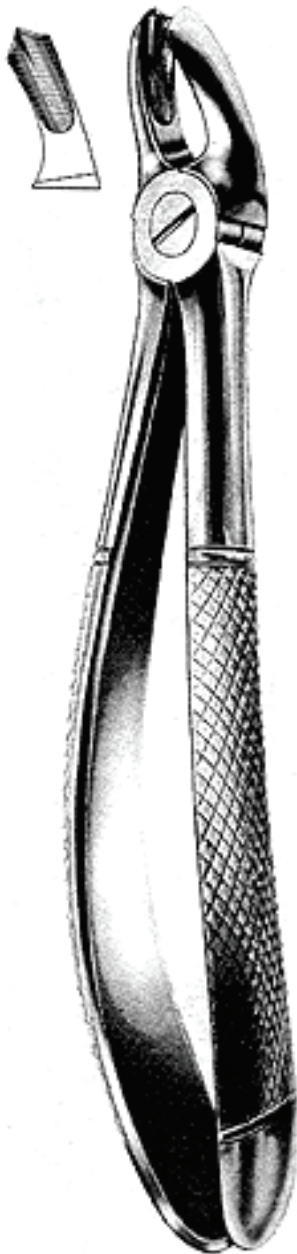

17
04-036-00
Right

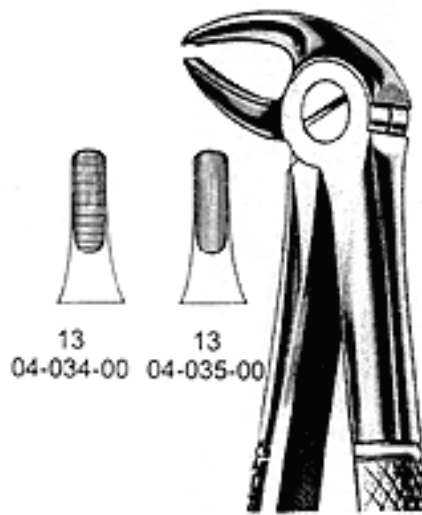

13 13
04-034-00 04-035-00

13
04-034-00

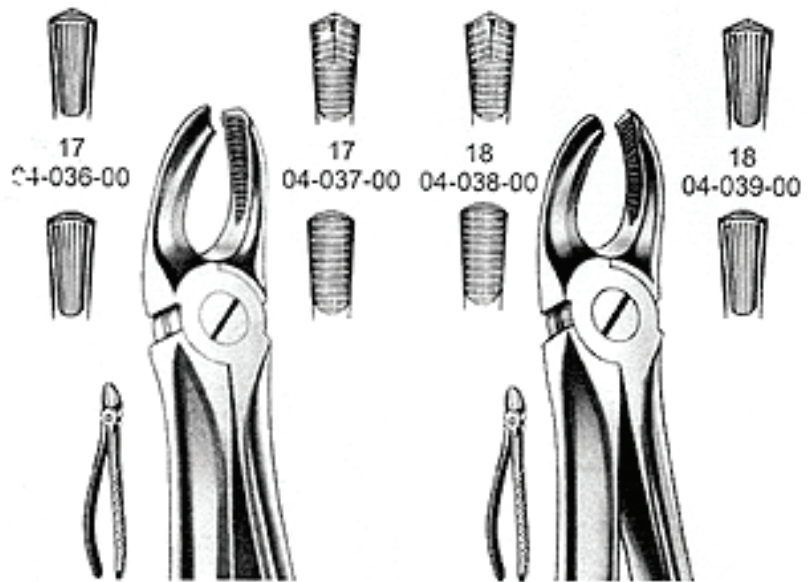

17
04-036-00

17
04-037-00

18
04-038-00

18
04-039-00

17
04-036-00
Right

18
04-038-00
Left



20
04-040-00
Molaron

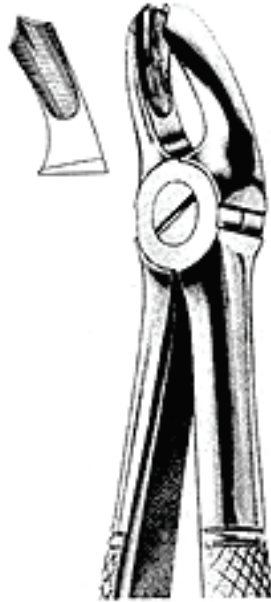

18 A
04-041-00

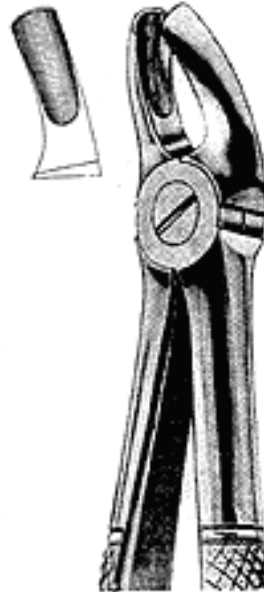

18 B
04-042-00



19
04-043-00



21
04-044-00



22
04-045-00



22 G
04-046-00

EXTRACTING FORCEPS, ENGLISH PATTERN
ZAHNZANGEN, ENGLISCHE FORM
FORCEPS DE EXTRACCION, FORMA ENGLESA

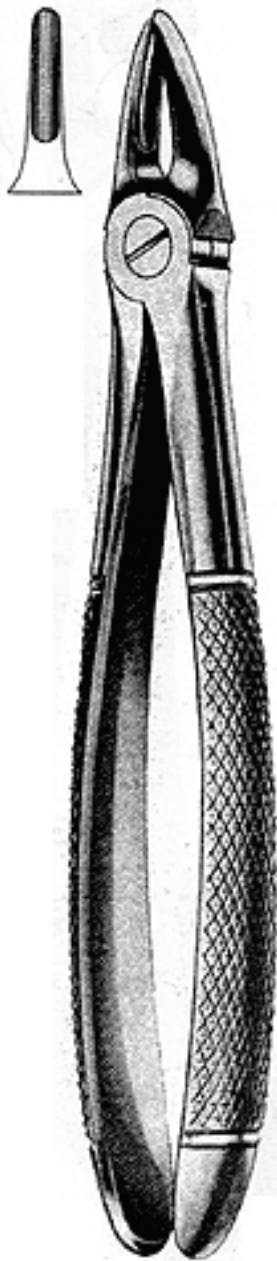

29
04-047-00



29 S
04-048-00

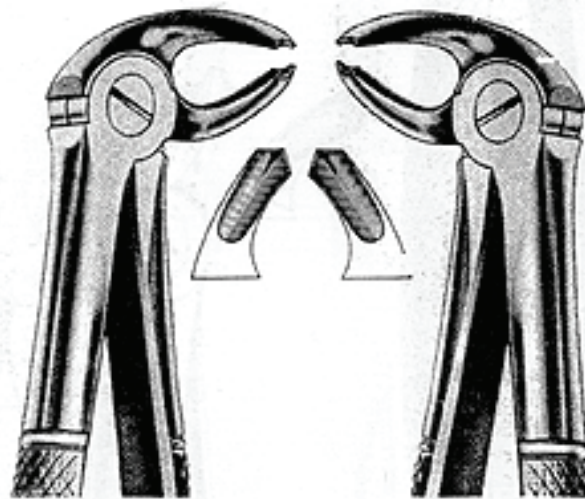

23
04-049-00
Right

24
04-050-00
Left



30
04-051-00

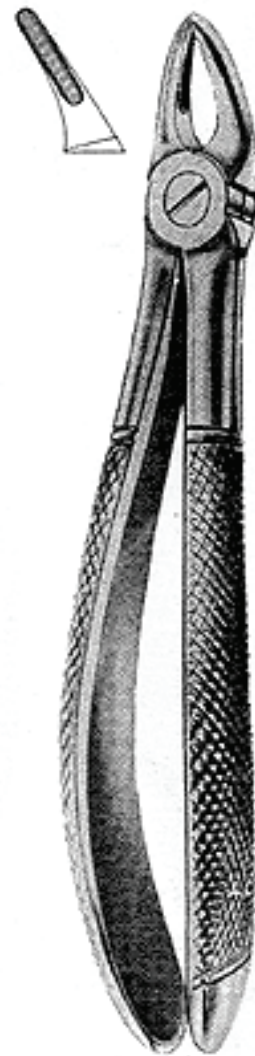

30 S
04-054-00



31
04-052-00



32
04-053-00

EXTRACTING FORCEPS, ENGLISH PATTERN
ZAHNZANGEN, ENGLISCHE FORM
FORCEPS DE EXTRACCION, FORMA ENGLESA

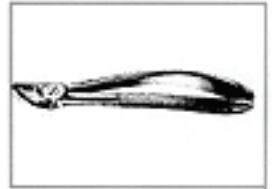

33
04-055-00



33 S
04-056-00

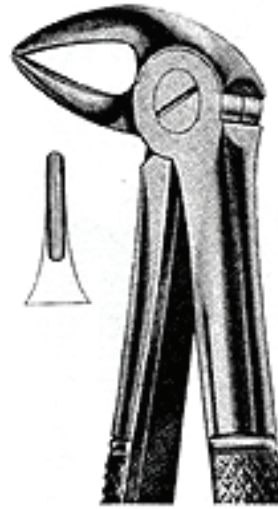

33 A
04-057-00



33 B
04-058-00

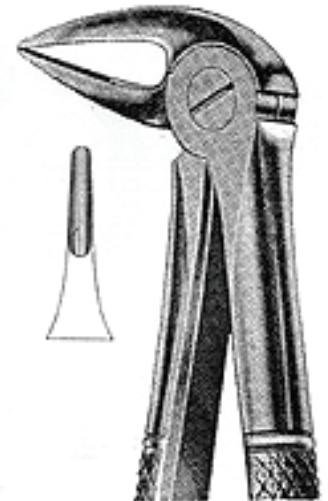

33 L
04-059-00

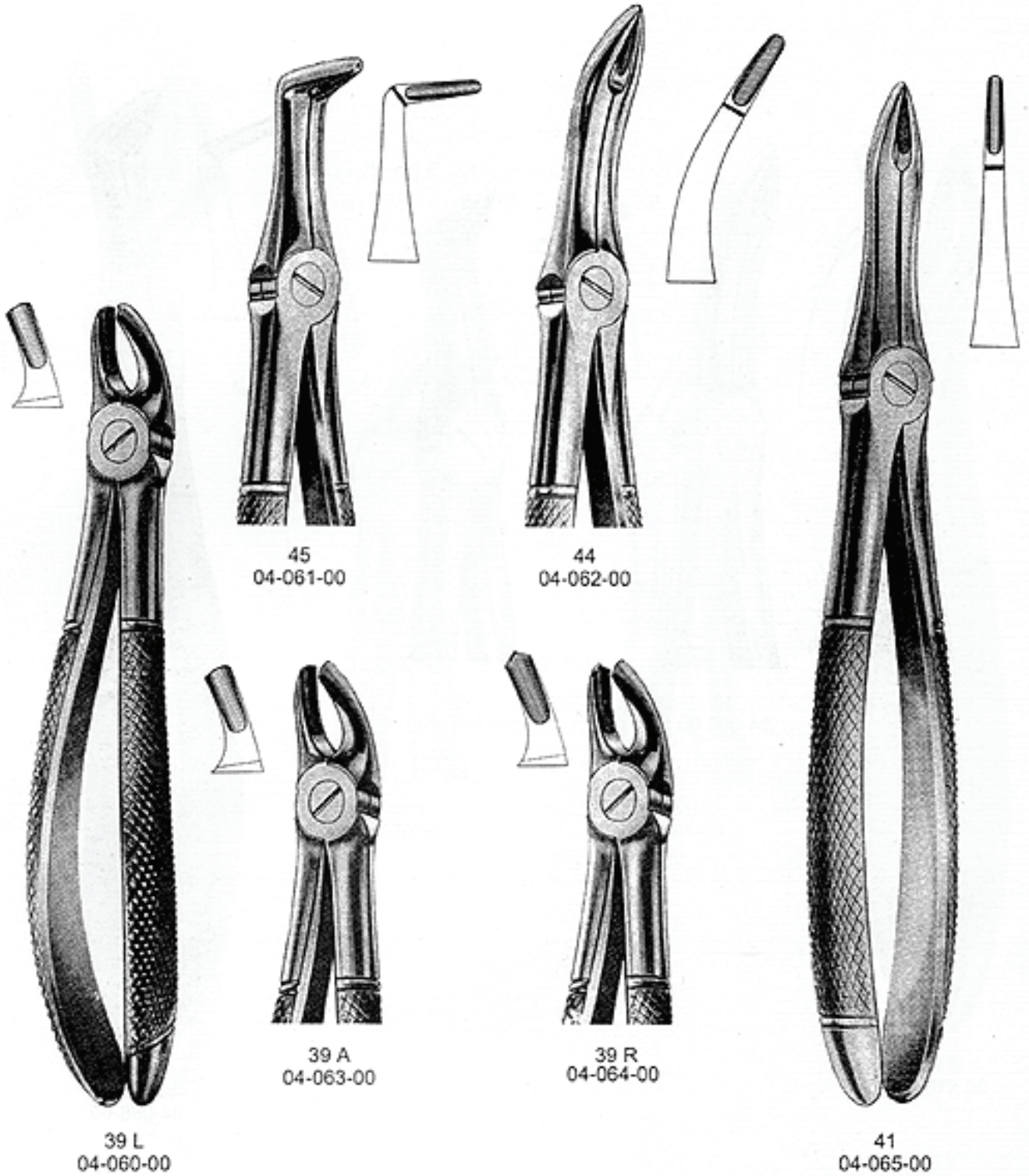

EXTRACTING FORCEPS, ENGLISH PATTERN
ZAHNZANGEN, ENGLISCHE FORM
FORCEPS DE EXTRACCION, FORMA ENGLESA

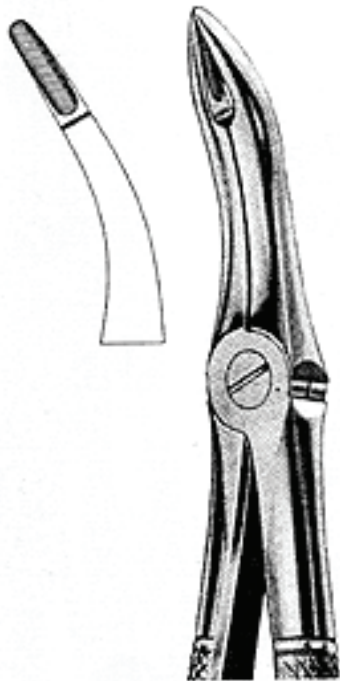

48
04-066-00

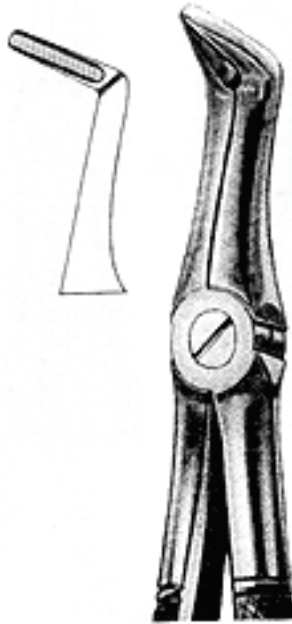

49
04-067-00

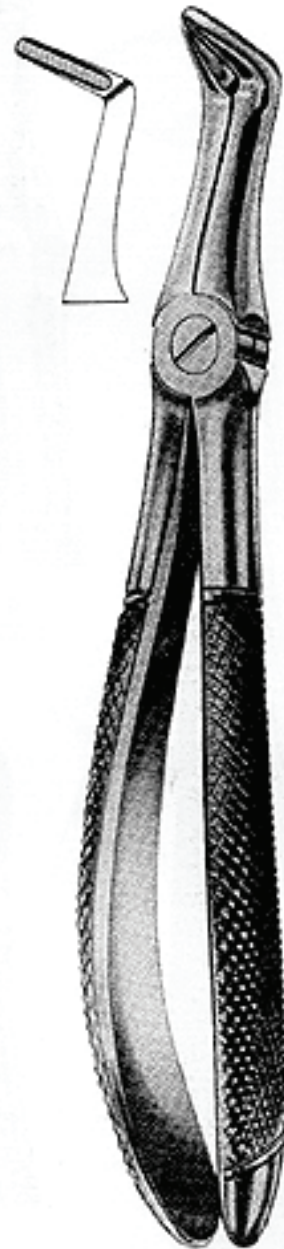

50
04-068-00



52
04-069-00

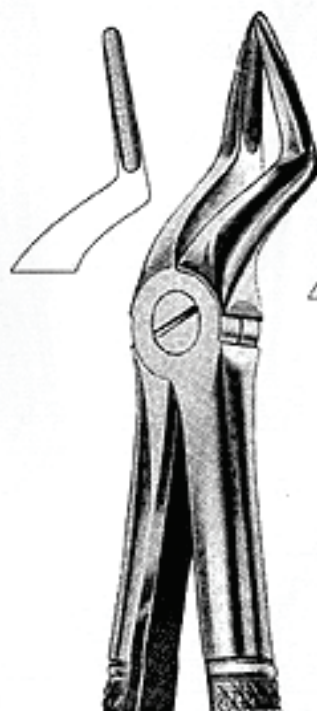

51A
04-070-00

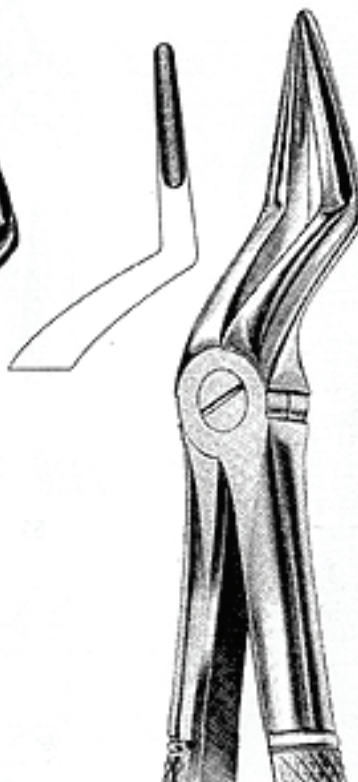

51L
04-071-00



51 S
04-072-00

EXTRACTING FORCEPS, ENGLISH PATTERN
ZAHNZANGEN, ENGLISCHE FORM
FORCEPS DE EXTRACCION, FORMA ENGLESA

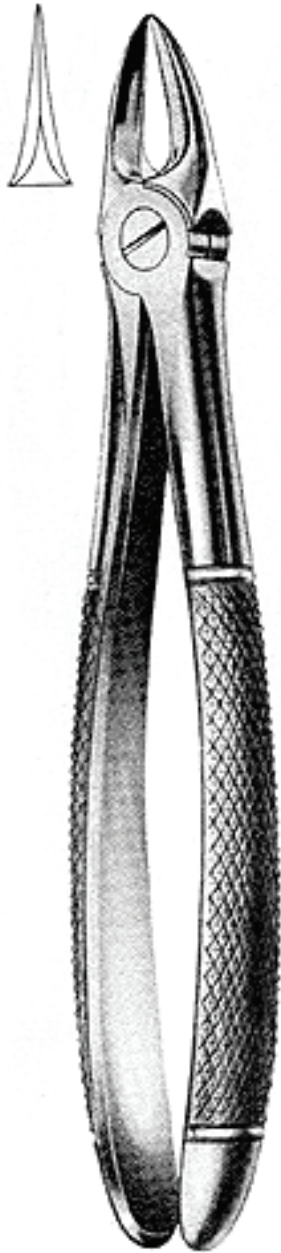

54
04-073-00

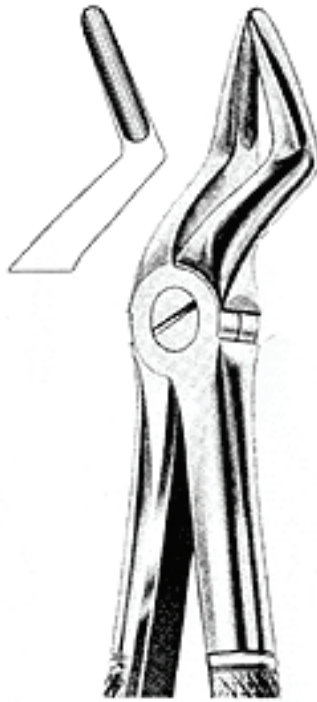

51
04-074-00

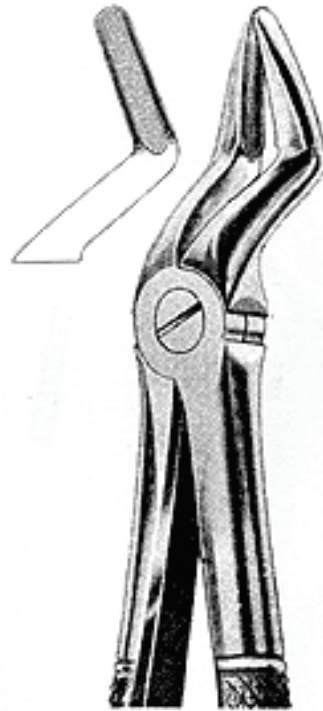

52 A
04-075-00



55
04-076-00



56
04-077-00

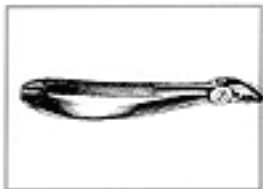

67½ L
 04-078-0C



67½ L
 04-078-00

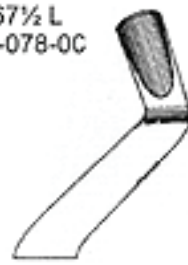

67½ L
 04-078-00



67½ R
 04-081-00



67½ R
 04-081-00



65 R
 04-079-00



65 L
 04-080-00

67½ R
 04-081-00

EXTRACTING FORCEPS, ENGLISH PATTERN
ZAHNZANGEN, ENGLISCHE FORM
FORCEPS DE EXTRACCION, FORMA ENGLESA

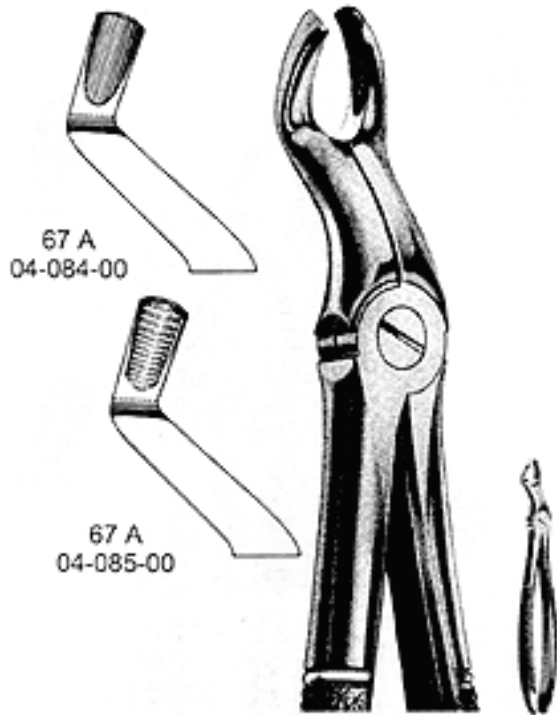
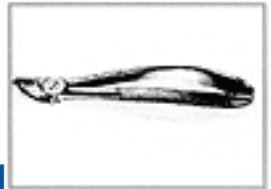

67 A
04-084-00

67 A
04-085-00

67 A
04-084-00

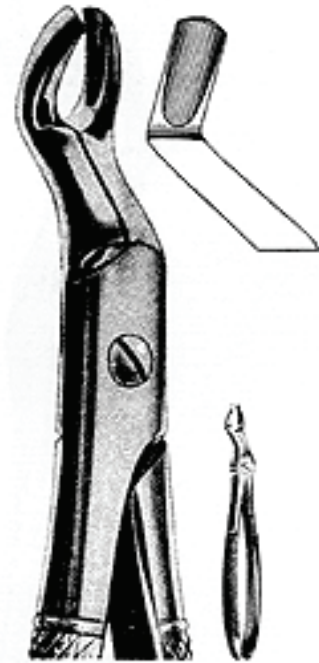

67
04-086-00



68
04-087-00



68 A
04-088-00



73 L
04-091-00



73 A
04-094-00



73 R
04-092-00

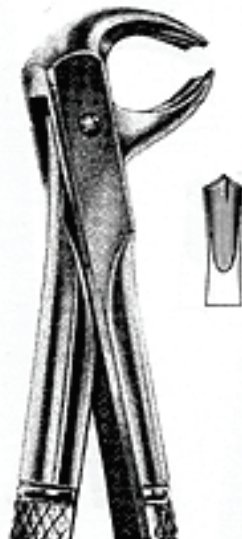

73
04-093-00

EXTRACTING FORCEPS, ENGLISH PATTERN
ZAHNZANGEN, ENGLISCHE FORM
FORCEPS DE EXTRACCION, FORMA ENGLESA



74 M
04-095-00

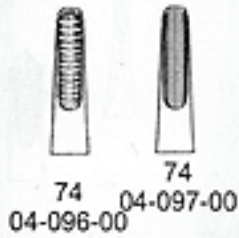

74 04-096-00
74 04-097-00

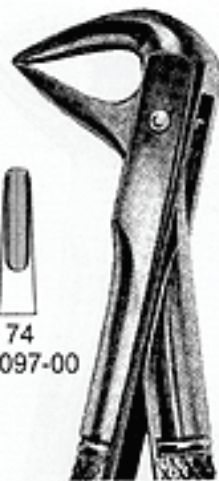

74
04-096-00

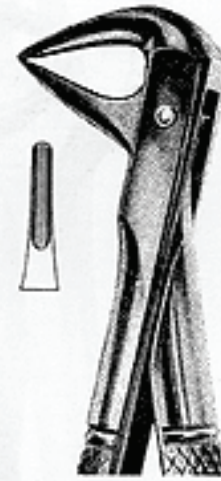

74 N
04-098-00



74 D
04-099-00

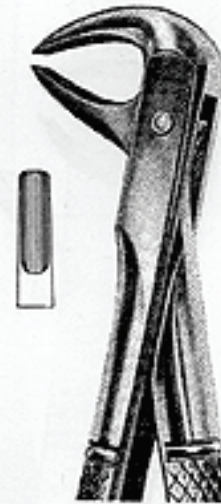

75
04-100-00

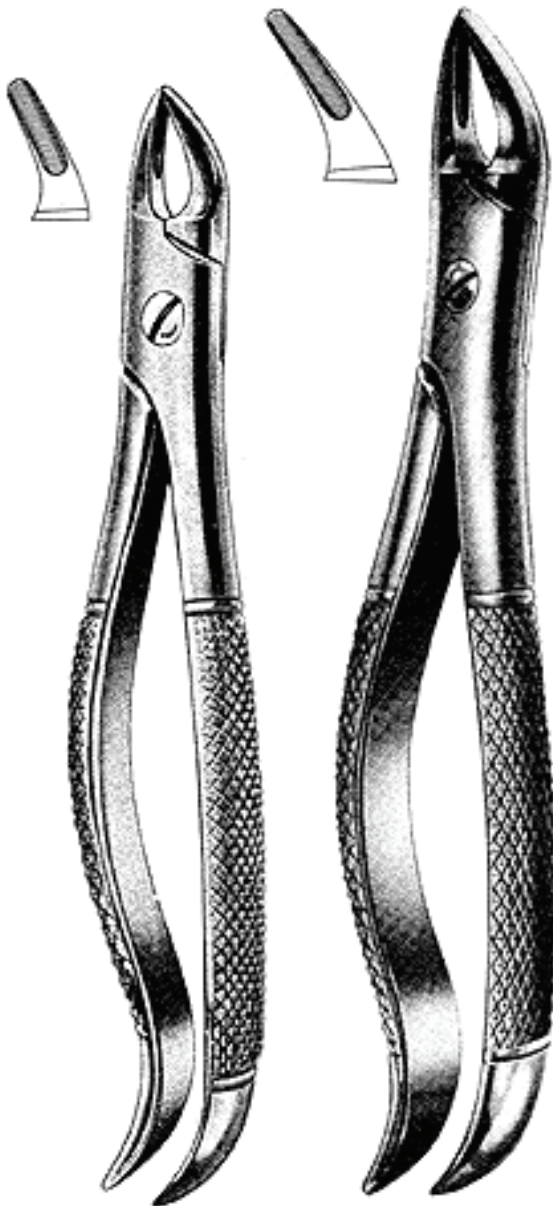

76
04-101-00

76 N
04-102-00

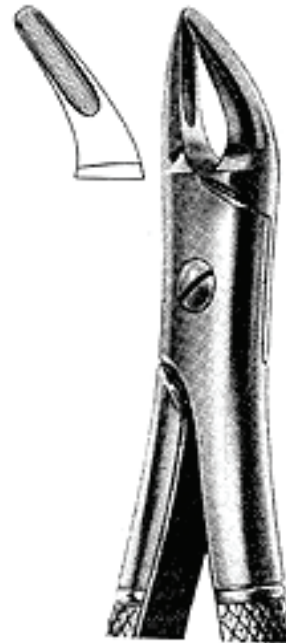

76 S
04-103-00



79A
04-104-00



79
04-105-00

EXTRACTING FORCEPS, ENGLISH PATTERN
ZAHNZANGEN, ENGLISCHE FORM
FORCEPS DE EXTRACCION, FORMA ENGLESA

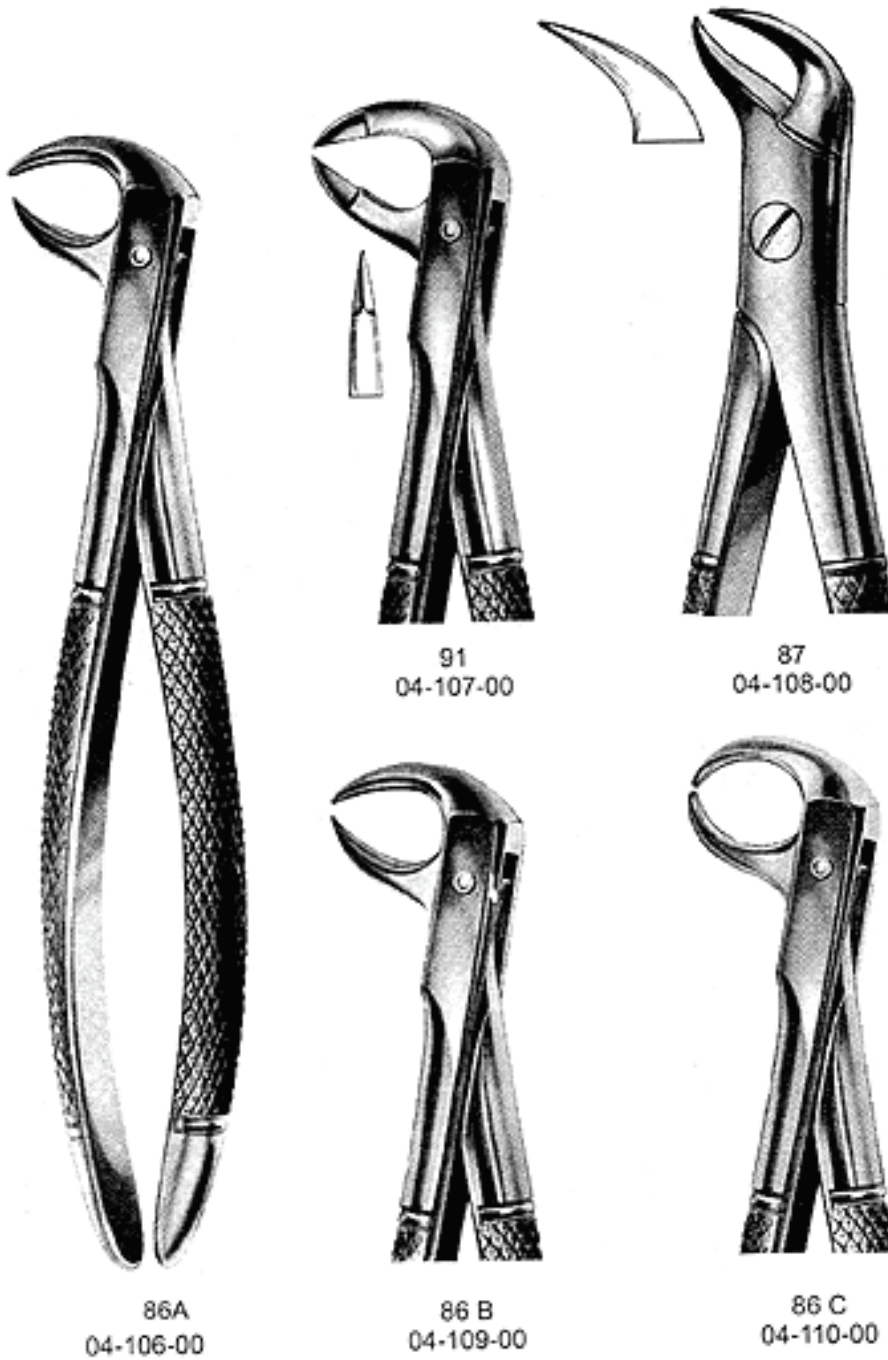

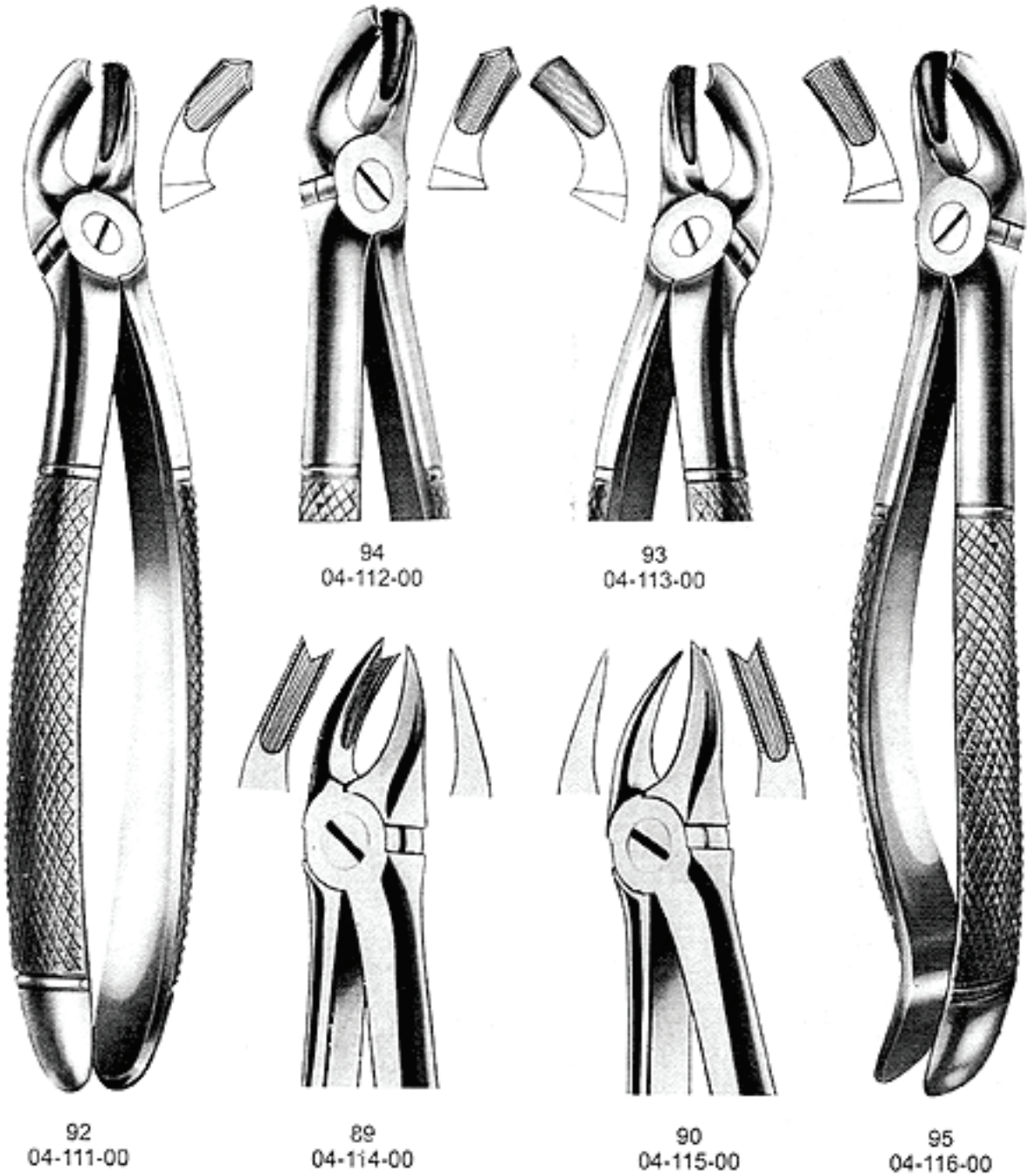

EXTRACTING FORCEPS, ENGLISH PATTERN
ZAHNZANGEN, ENGLISCHE FORM
FORCEPS DE EXTRACCION, FORMA ENGLESA

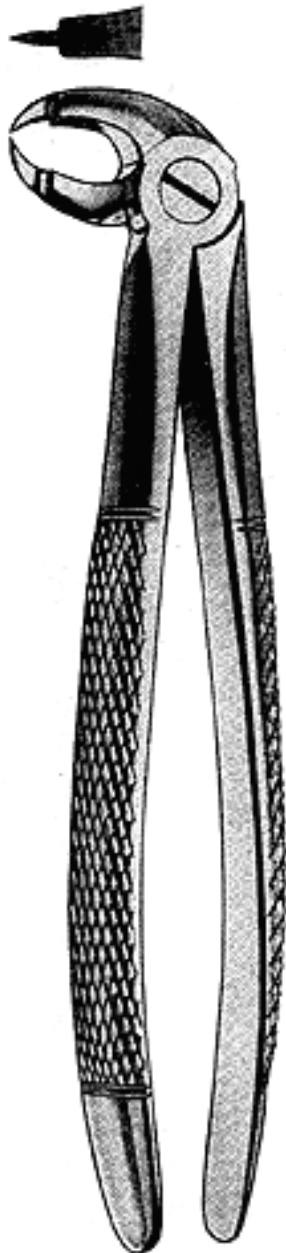

98
04-117-00



99
04-118-00



991/2
04-119-00

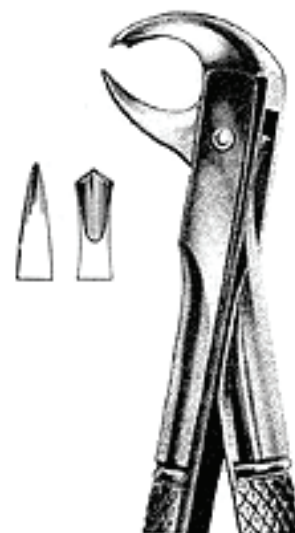

991/4
04-120-00

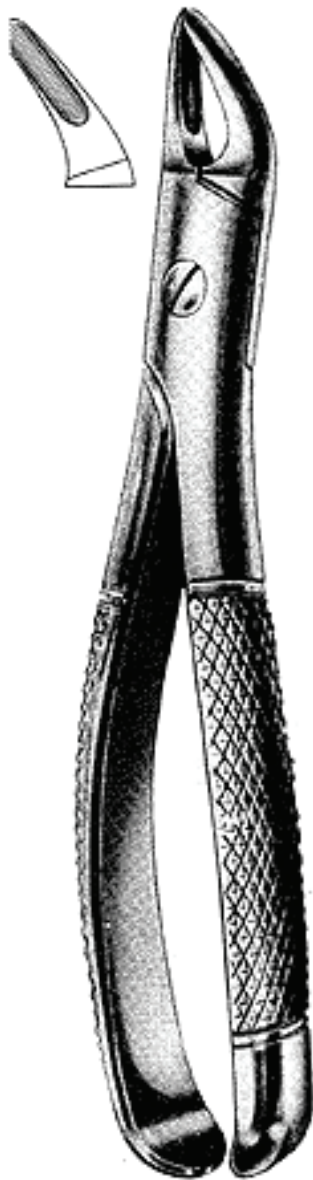

100
04-121-00

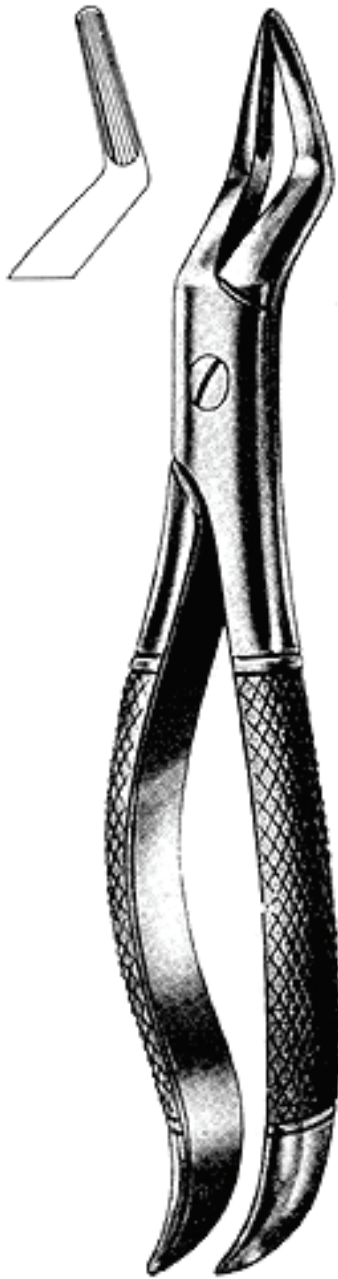

101
04-122-00

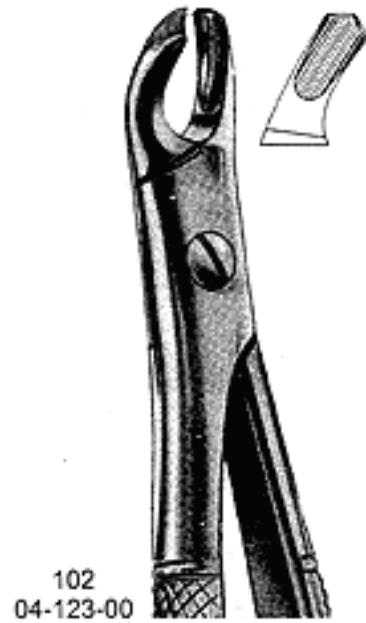

102
04-123-00

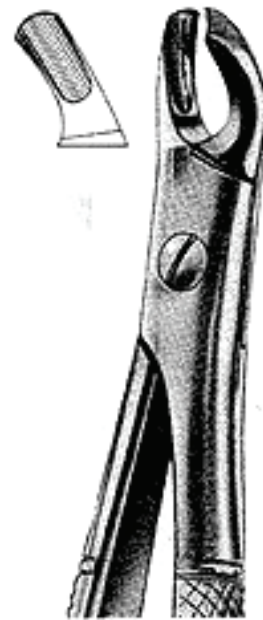

103
04-124-00

EXTRACTING FORCEPS, ENGLISH PATTERN
ZAHNZANGEN, ENGLISCHE FORM
FORCEPS DE EXTRACCION, FORMA ENGLESA

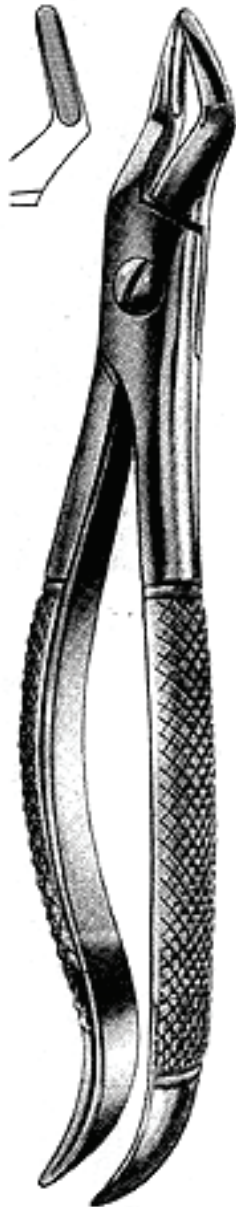

104
04-125-00



105
04-126-00

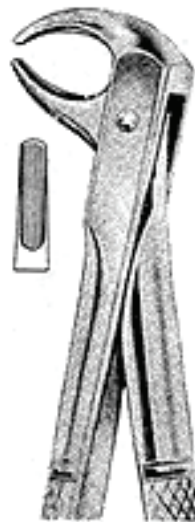

106
04-127-00

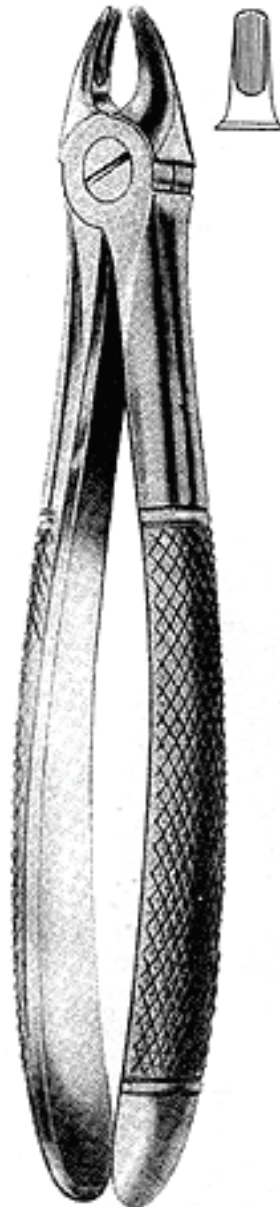

107
04-128-00

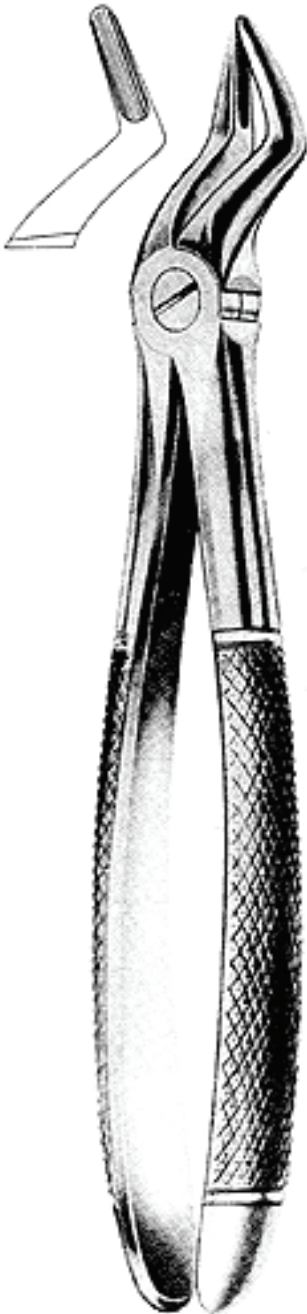

112
04-129-00



113
04-130-00

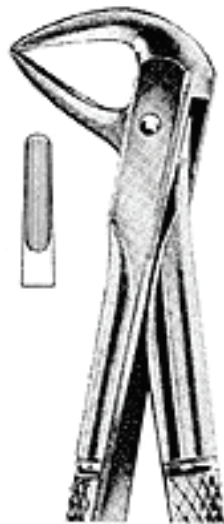

114
04-131-00

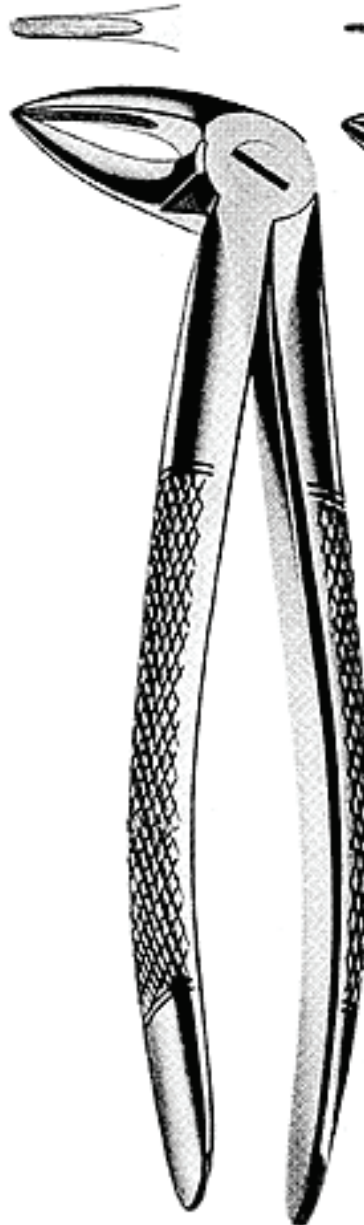

133 1/2
04-132-00

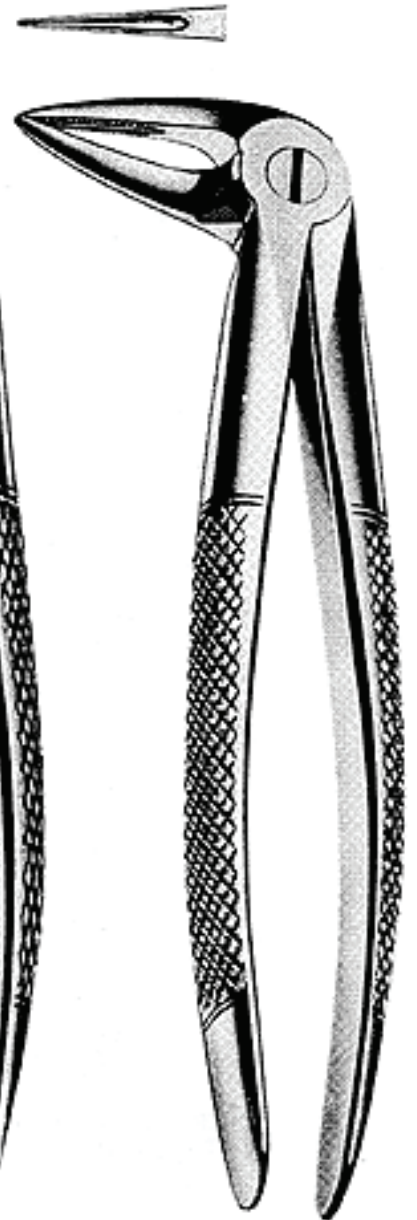

33 1/2
04-133-00

EXTRACTING FORCEPS, ENGLISH PATTERN
ZAHNZANGEN, ENGLISCHE FORM
FORCEPS DE EXTRACCION, FORMA ENGLESA

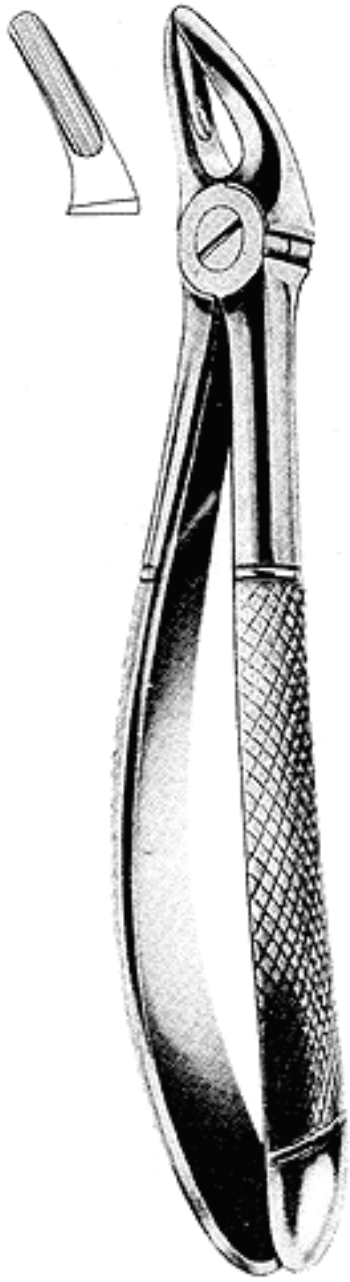

136
04-134-00

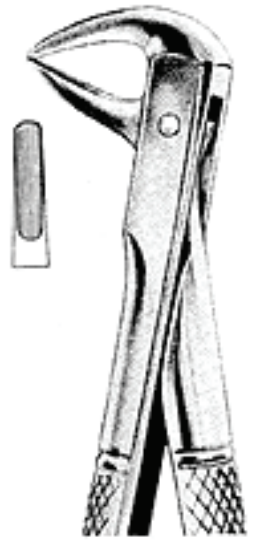

137
04-135-00

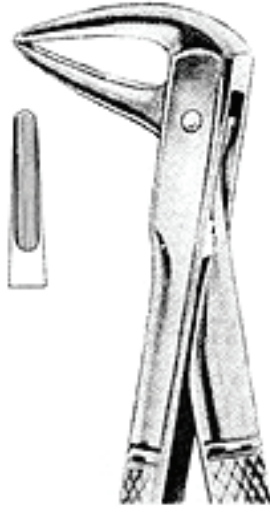

143
04-136-00

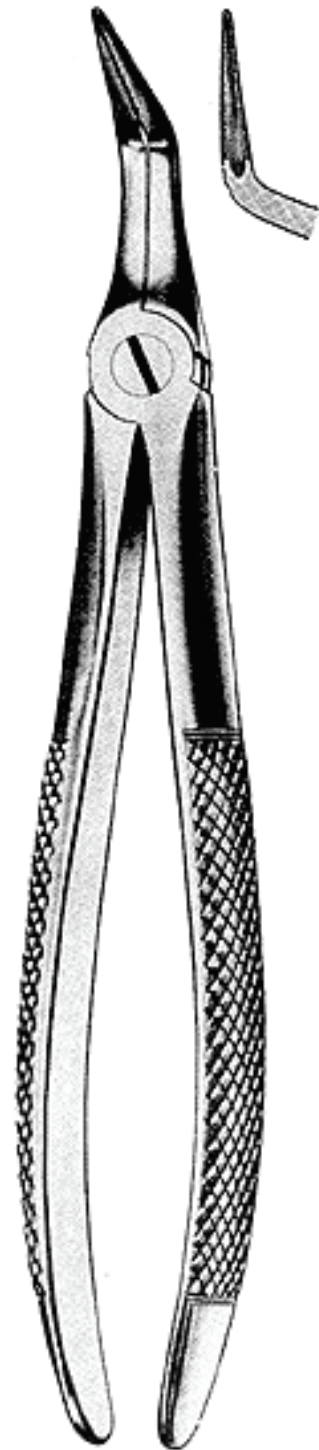

145
04-137-00

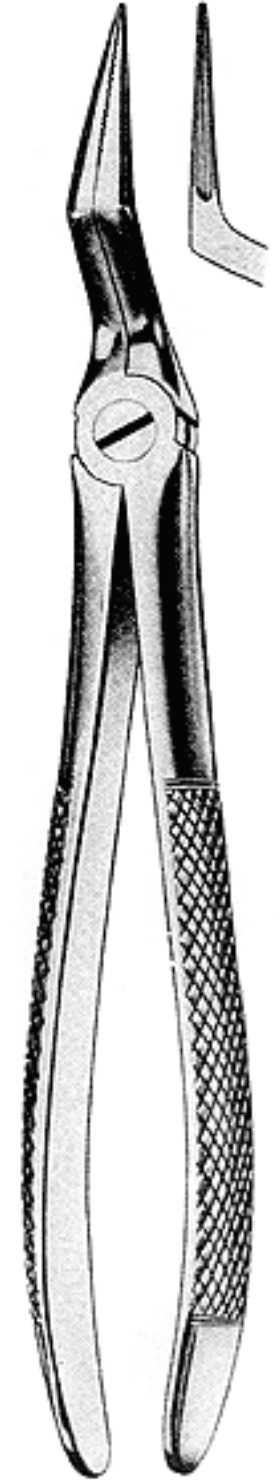

151 1/2
04-138-00



STUDENT SET, AVAILABLE
TEN PIECE IN ONE PACKING

ONE SET CONTAINS:	
1 X# 2	1 X# 51
1 X# 7	1 X# 67
1 X# 13	1 X# 73
1 X# 18	1 X# 74
1 X# 17	1 X# 79A

04-175-00

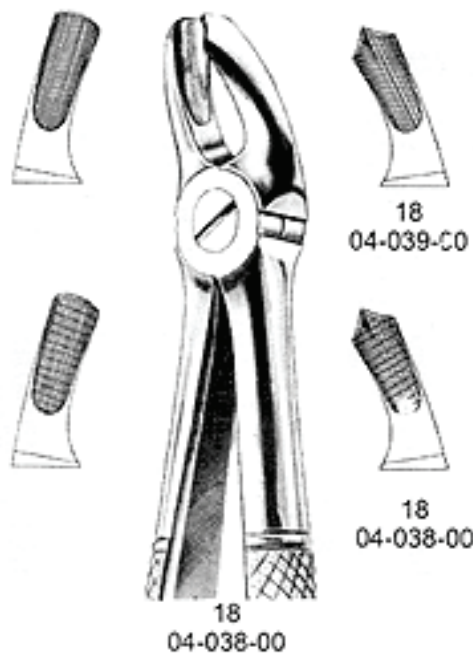
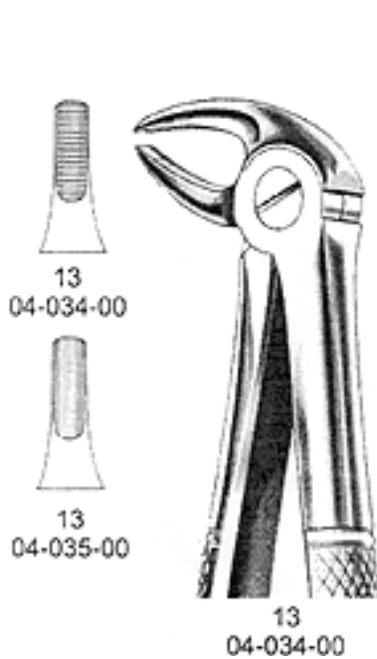
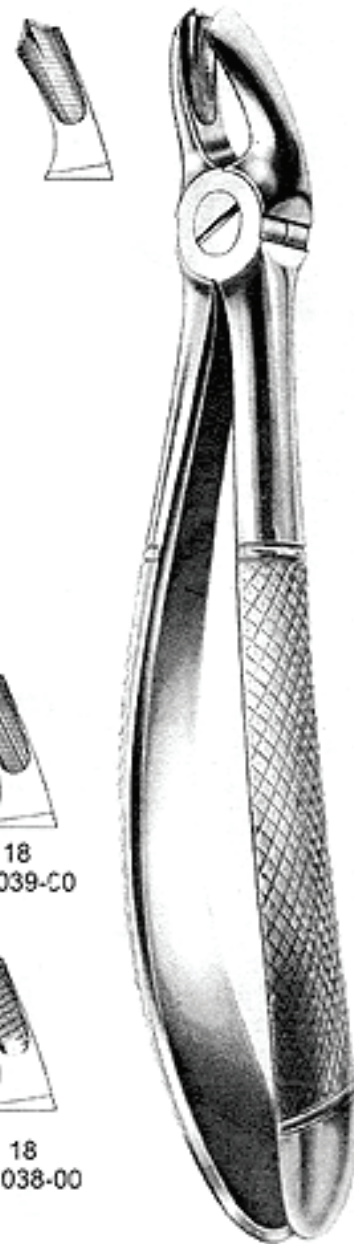
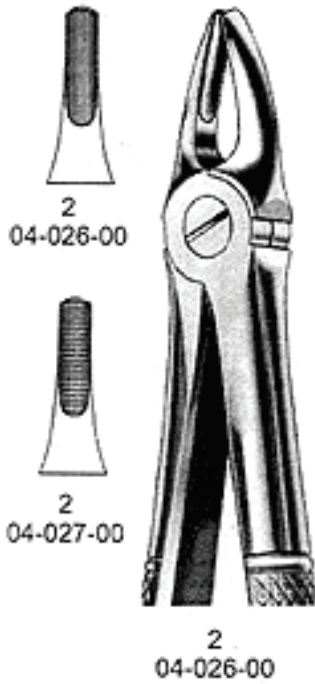

**STUDENTS SET
CONSISTING 10 EXTRACTIONS FORCEPS**



ONE SET CONTAINS:			
1 X # 2	04-026-00, 04-027-00	1 X # 51	04-069-00, 04-070-00
1 X # 7	04-030-00, 04-031-00	1 X # 67	04-086-00.
1 X # 13	04-034-00, 04-035-00	1 X # 73	04-093-00.
1 X # 18	04-038-00, 04-039-00	1 X # 74	04-096-00, 04-097-00
1 X # 17	04-033-00.	1 X # 79A	04-105-00

**STUDENT SET, AVAILABLE
TEN PIECE IN ONE PACKING**

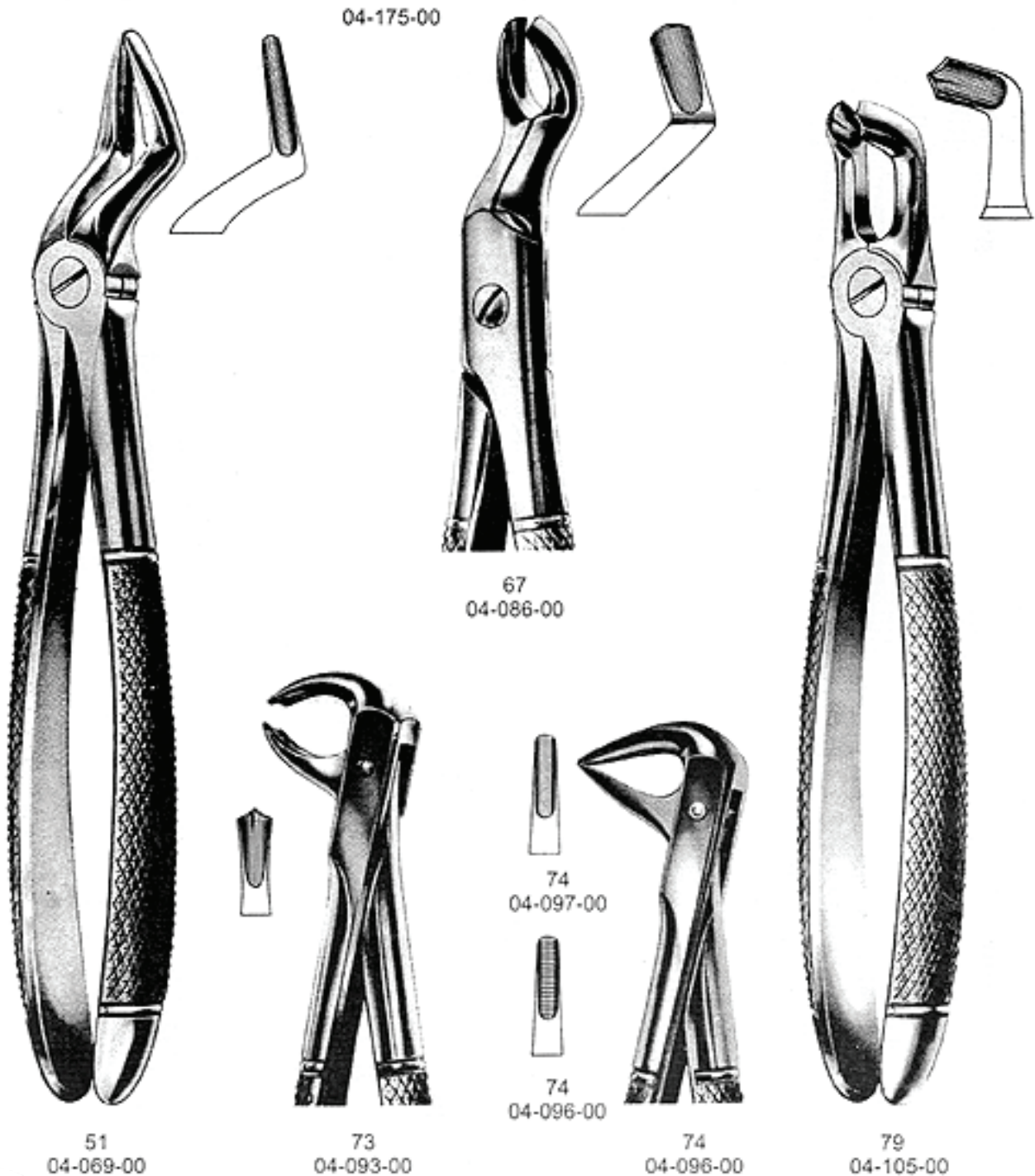



STUDENTS SET
EXTRACTING FORCEPS FOR CHILDREN, ENGLISH PATTERN
FOR CHILDREN PACK OF 5 PIECES

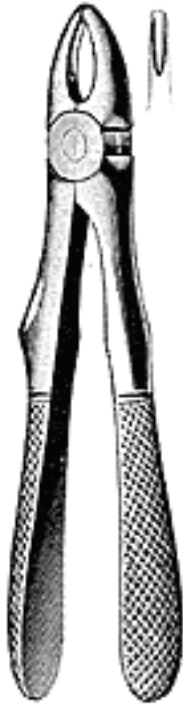

1
04-275-00

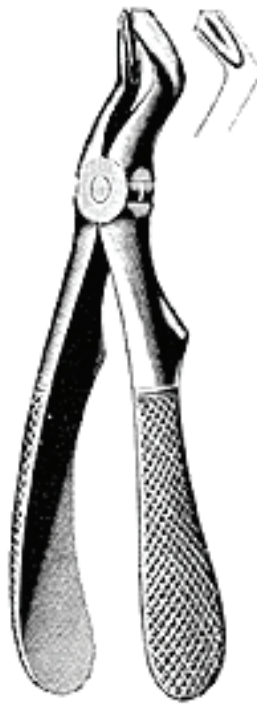

3
04-276-00

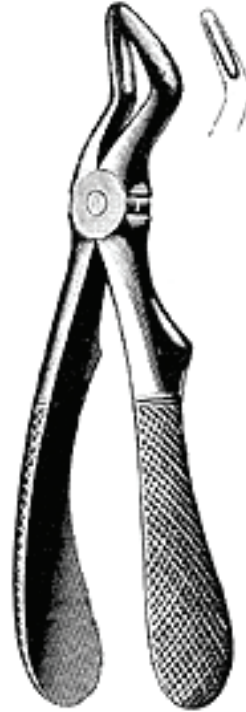

4
04-280-00

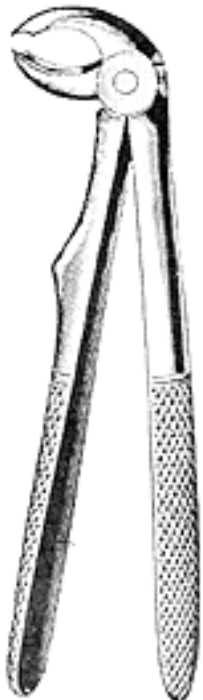

6
04-281-00



7
04-278-00

ONE SET CONTAINS:
 1 X # 1 04-275-00
 1 X # 3 04-276-00
 1 X # 4 04-280-00
 1 X # 6 04-281-00
 1 X # 7 04-278-00

04-176-00

WITH SPRING
 04-177-00

RESECTION FORCEPS
PINCES A RESECCION
FORCEPS DE RESECCION

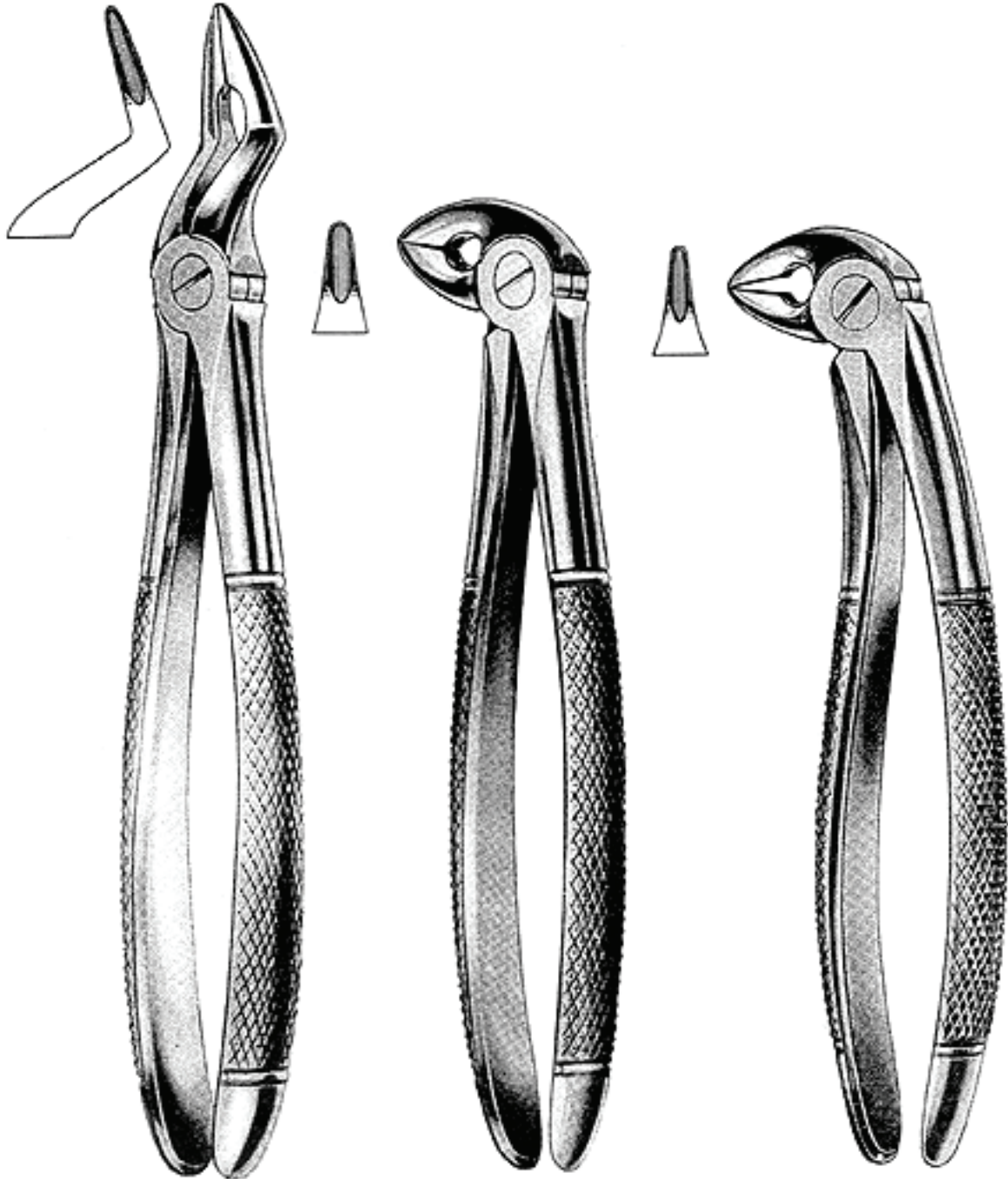

04-161-00
Witzel

04-162-00

Busch

04-163-00

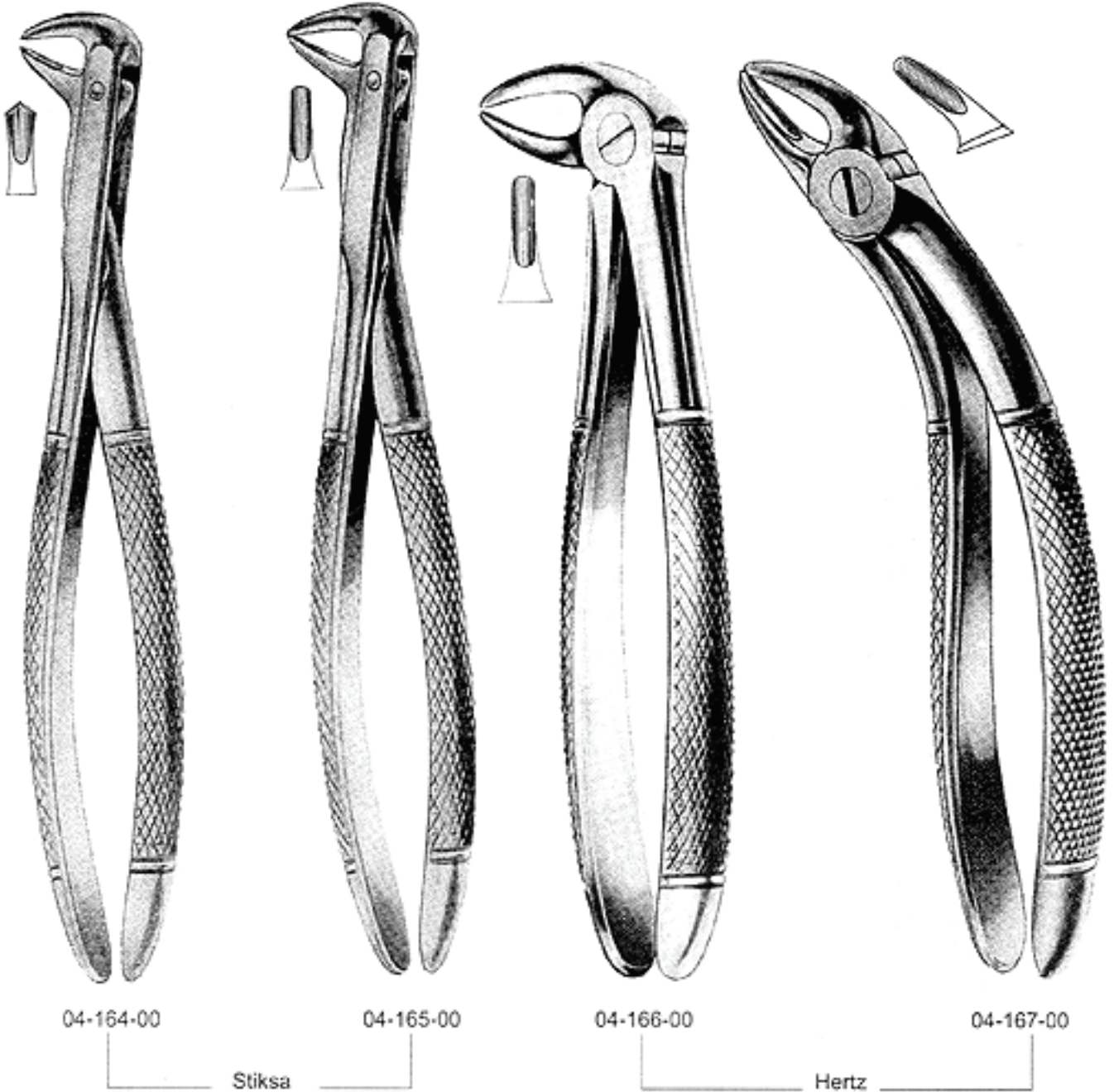

WISDOM EXTRACTING FORCEPS
DAVIERS POUR DENTS DE SAGESSE
FORCEPS PARA CORDALES

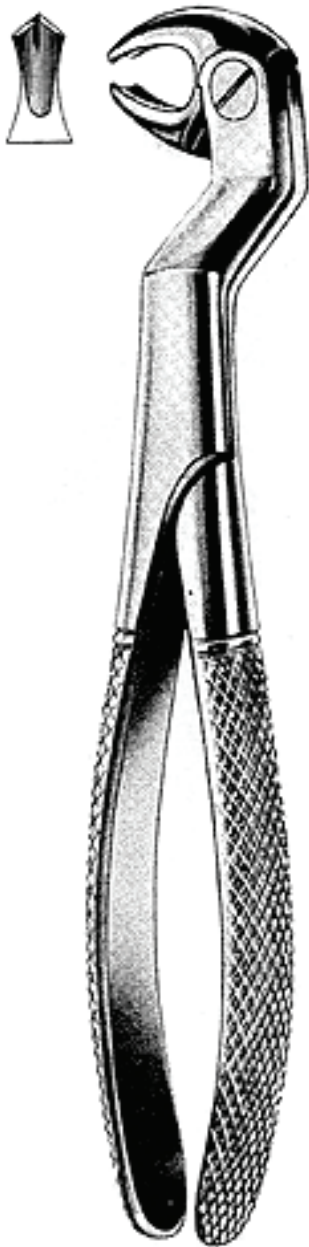
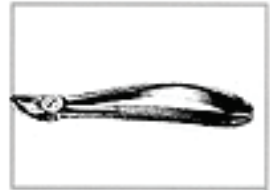

22 1/2 L
04-168-00

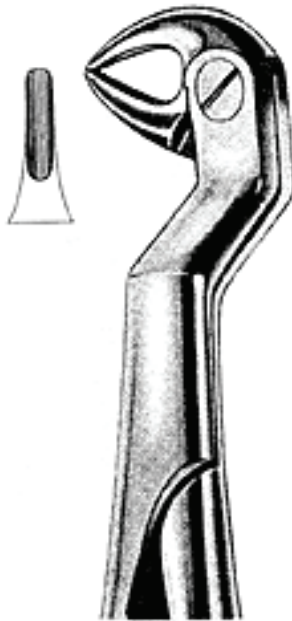

33 1/2 L
04-169-00



33 1/2 R
04-170-00

Routurier



22 1/2 R
04-171-00

Routurier

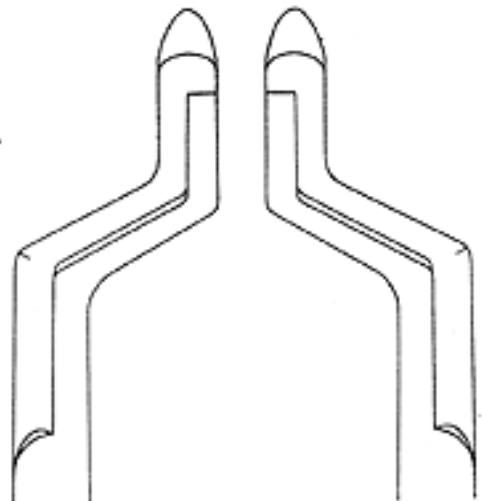

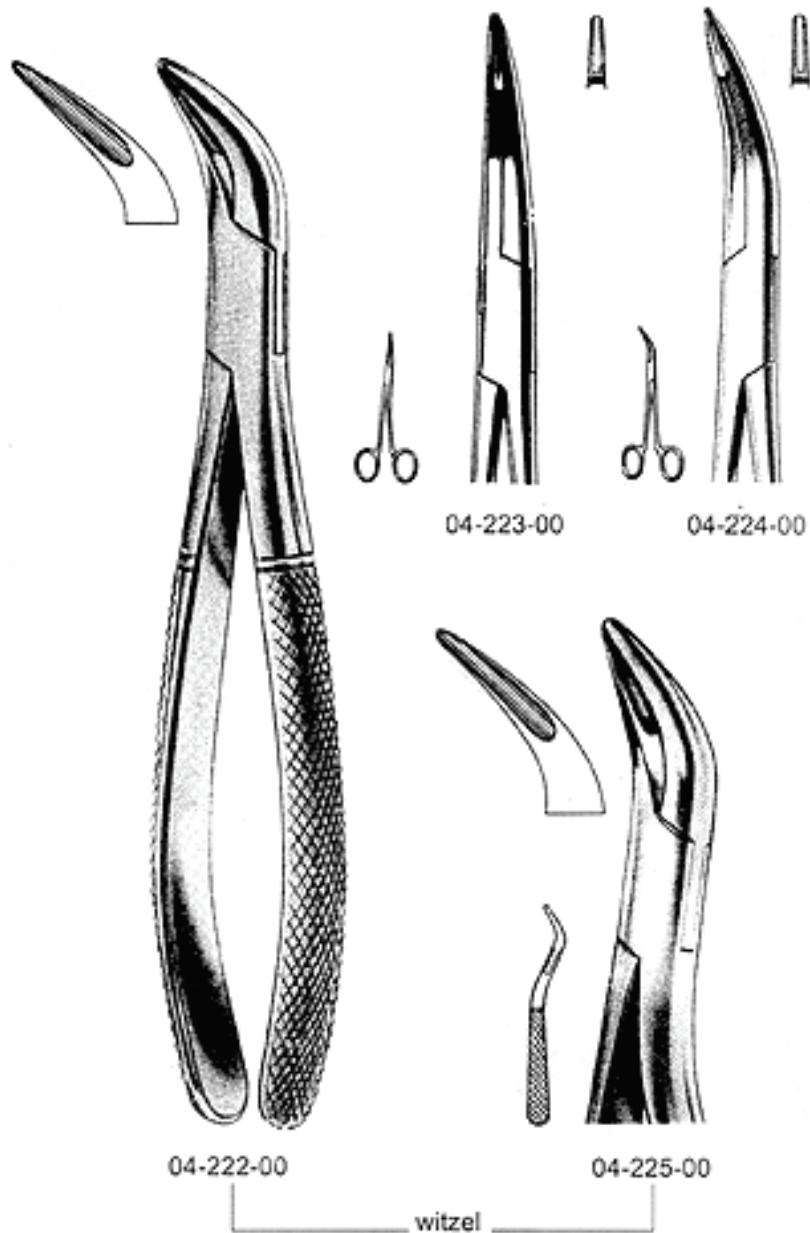

EXTRACTING FORCEPS, FOR CHILDREN, ENGLISH PATTERN
ZAHNZANGE FUR KINDER MIT, ENGLISCHE FORM
FORCEPS DE EXTRACCION PARA CON, FORMA ENGLISH

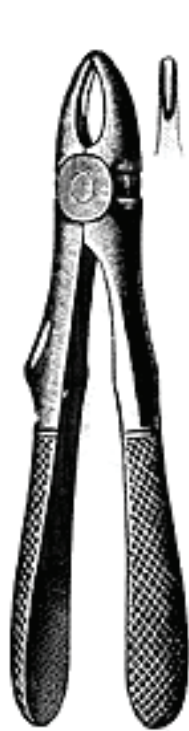

1
04 275-00



3
04 276-00



5
04 277-00



7
04 278-00

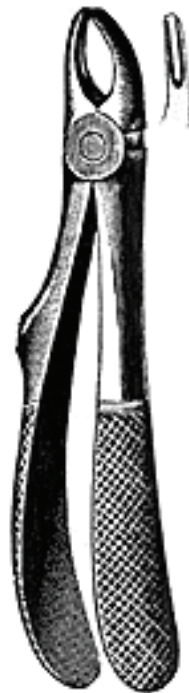

2
04 279-00

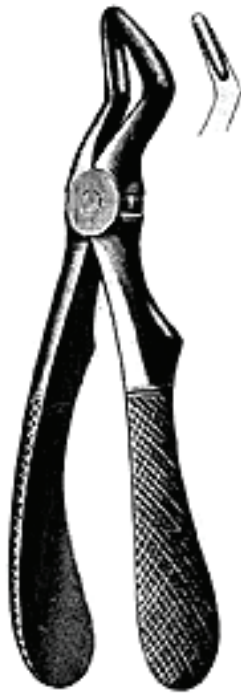

4
04-280-00



6
04-281-00



137
04-282-00



139
04-283-00

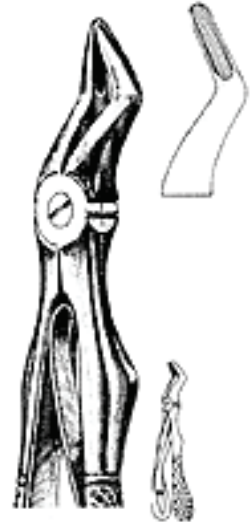

51
04-284-00

Klein

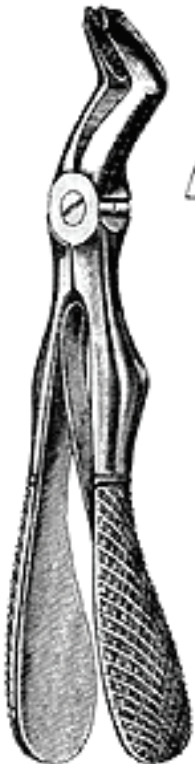

3
04-285-00

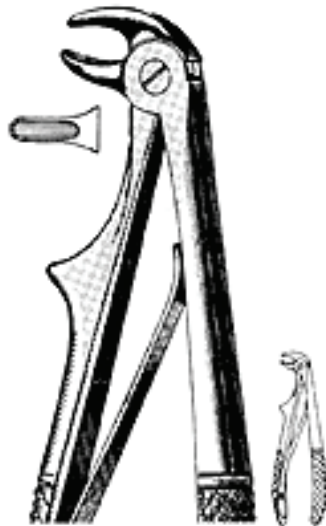

5
04-286-00



6
04-287-00

Klein

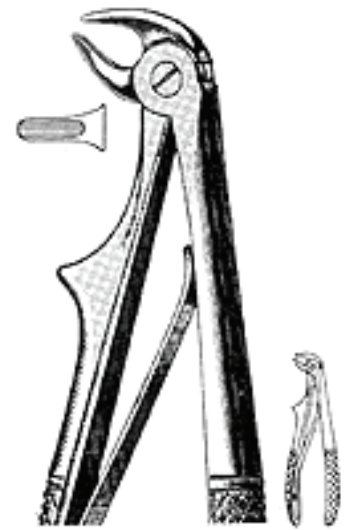

7
04-288-00

EXTRACTING FORCEPS, ENGLISH PATTERN
 ZAHNZANGE ENGLISCHE FORM
 FORCEPS DE EXTRACCION FORMA ENGLESA



13 K
04-289-00



33 K
04-290-00



40
04-291-00



22 K
04-292-00



38
04-293-00



73 K
04-294-00



17 K
 04-295-00



18 K
 04-296-00

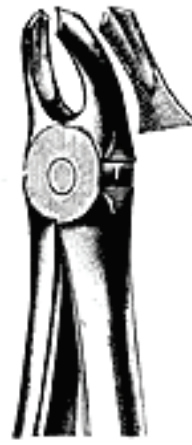

18 K
 04-297-00



29 K
 04-298-00



51 K
 04-299-00



39 K
 04-300-00



37
 04-301-00

EXTRACTING FORCEPS, ENGLISH PATTERN
ZAHNZANGE ENGLISCHE FORM
FORCEPS DE EXTRACCION FORMA ENGLESA



**WITH DIAMOND
DUST COATING**

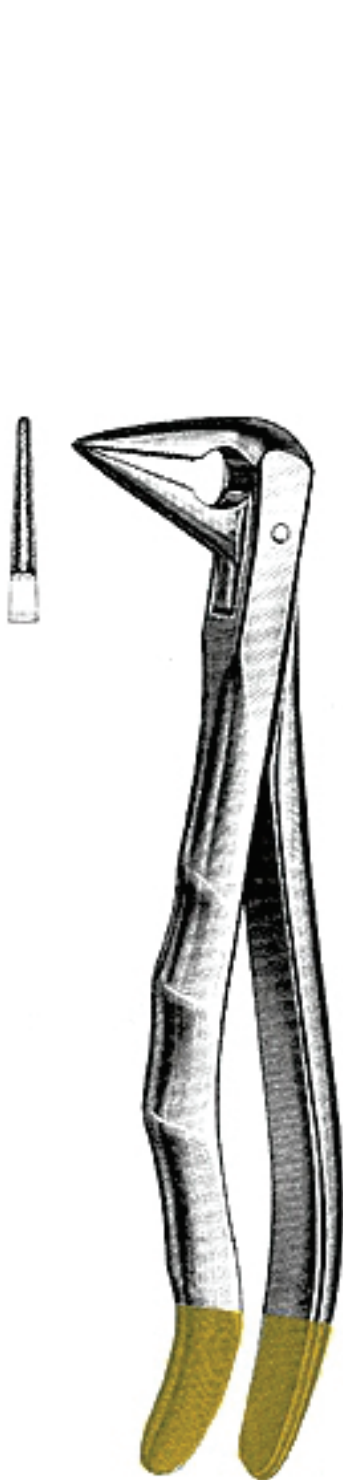

59
04-351-00

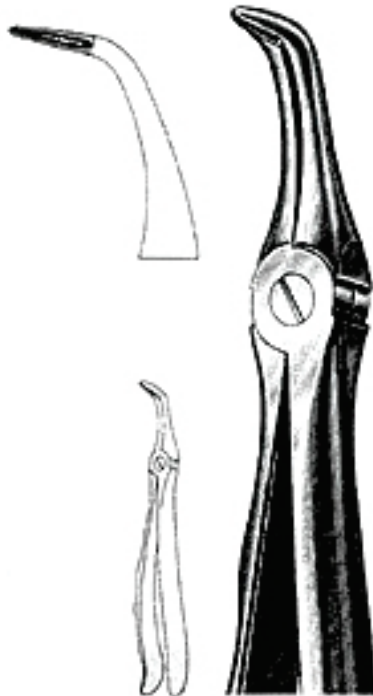

46
04-352-00

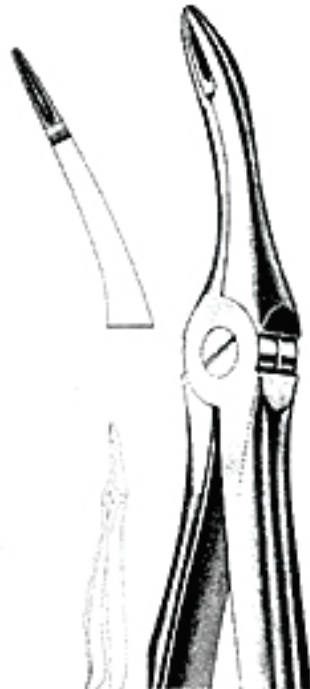

49
04-353-00

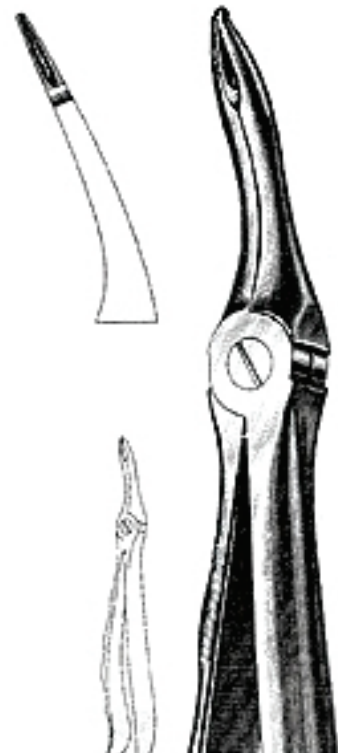

44
04-354-00



1
 04-405-00
 Standard

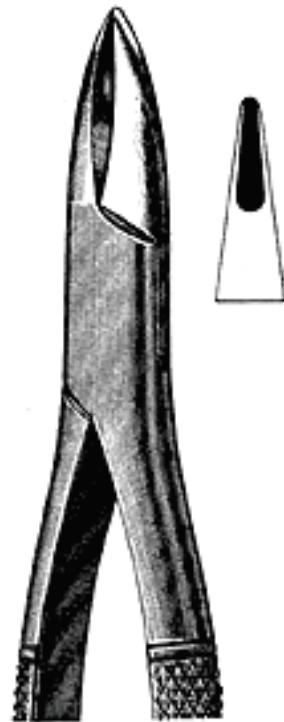

1 A
 04-406-00
 Henahan

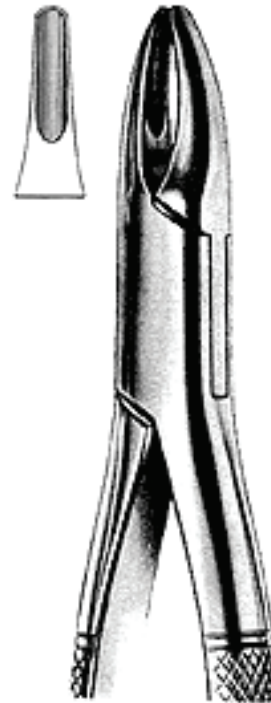

1 B
 04-407-00
 Normal

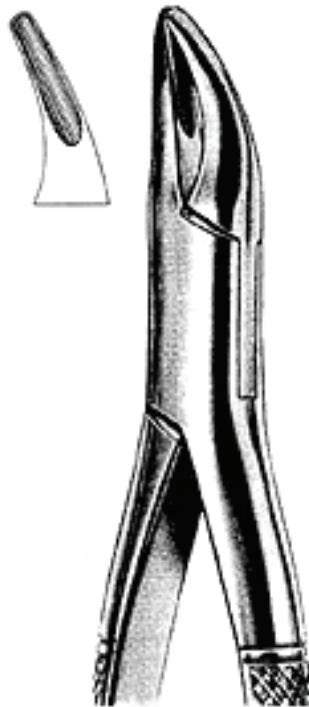

2
 04-408-00



3
 04-409-00

EXTRACTING FORCEPS, AMERICAN PATTERN
ZAHNZANGE AMERICAN FORM
FORCEPS DE EXTRACCION FORMA AMERICANA

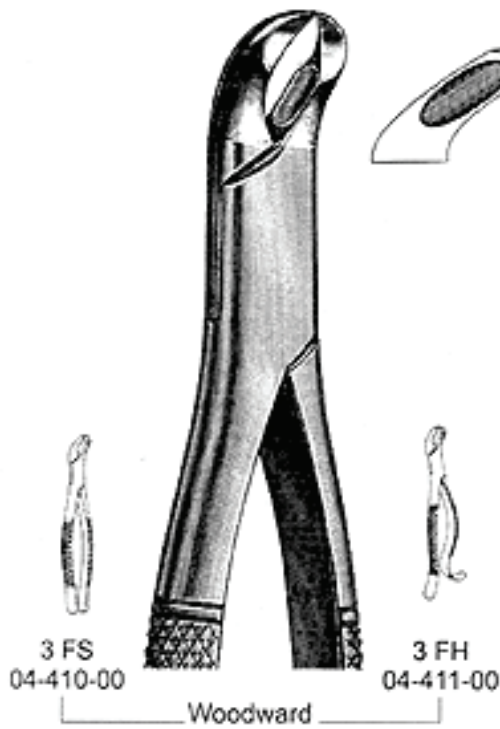

10 S
04-413-00
Standard

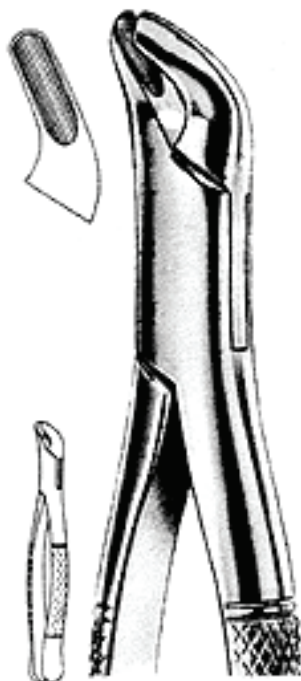
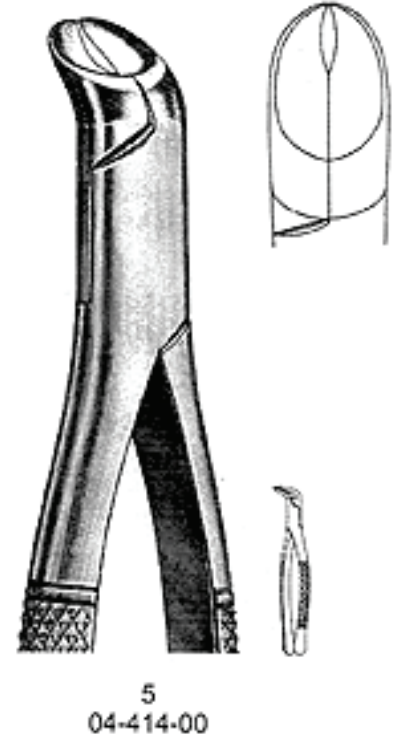

4
04-412-00

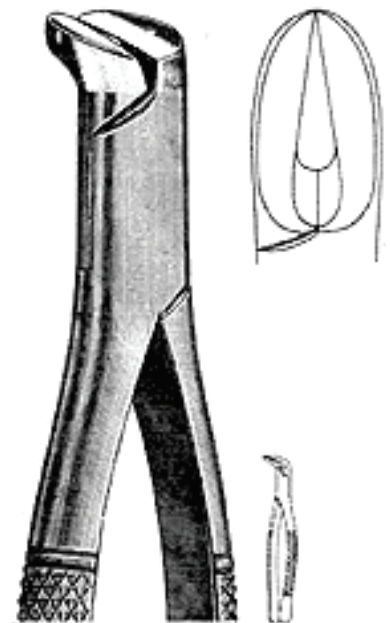

6
04-415-00

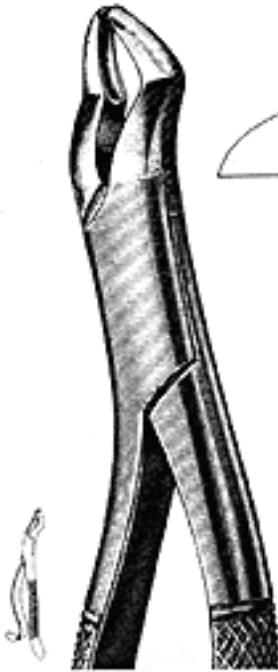

10 H
 04-416-00



13
 04-417-00



14
 04-418-00

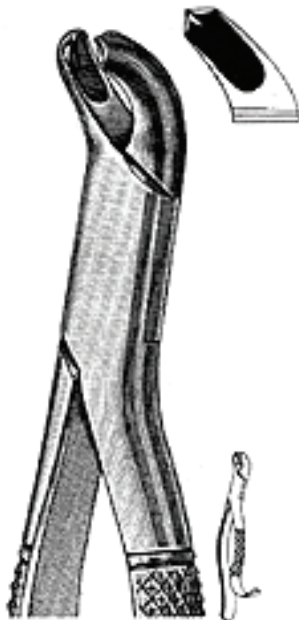

15
 04-419-00
 Harris

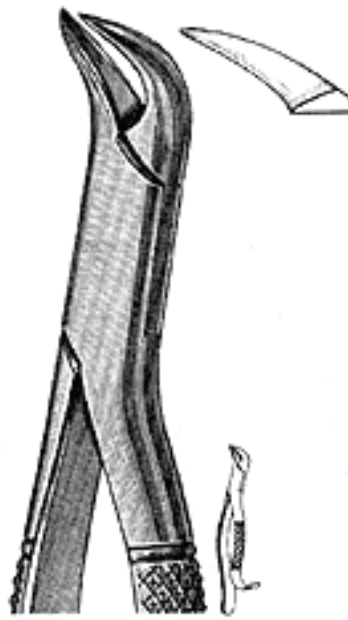

16
 04-420-00

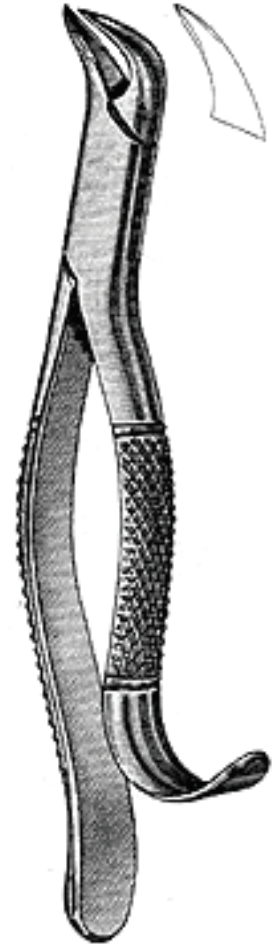

16 S
 04-421-00

EXTRACTING FORCEPS, AMERICAN PATTERN
ZAHNZANGE AMERICAN FORM
FORCEPS DE EXTRACCION FORMA AMERICANA

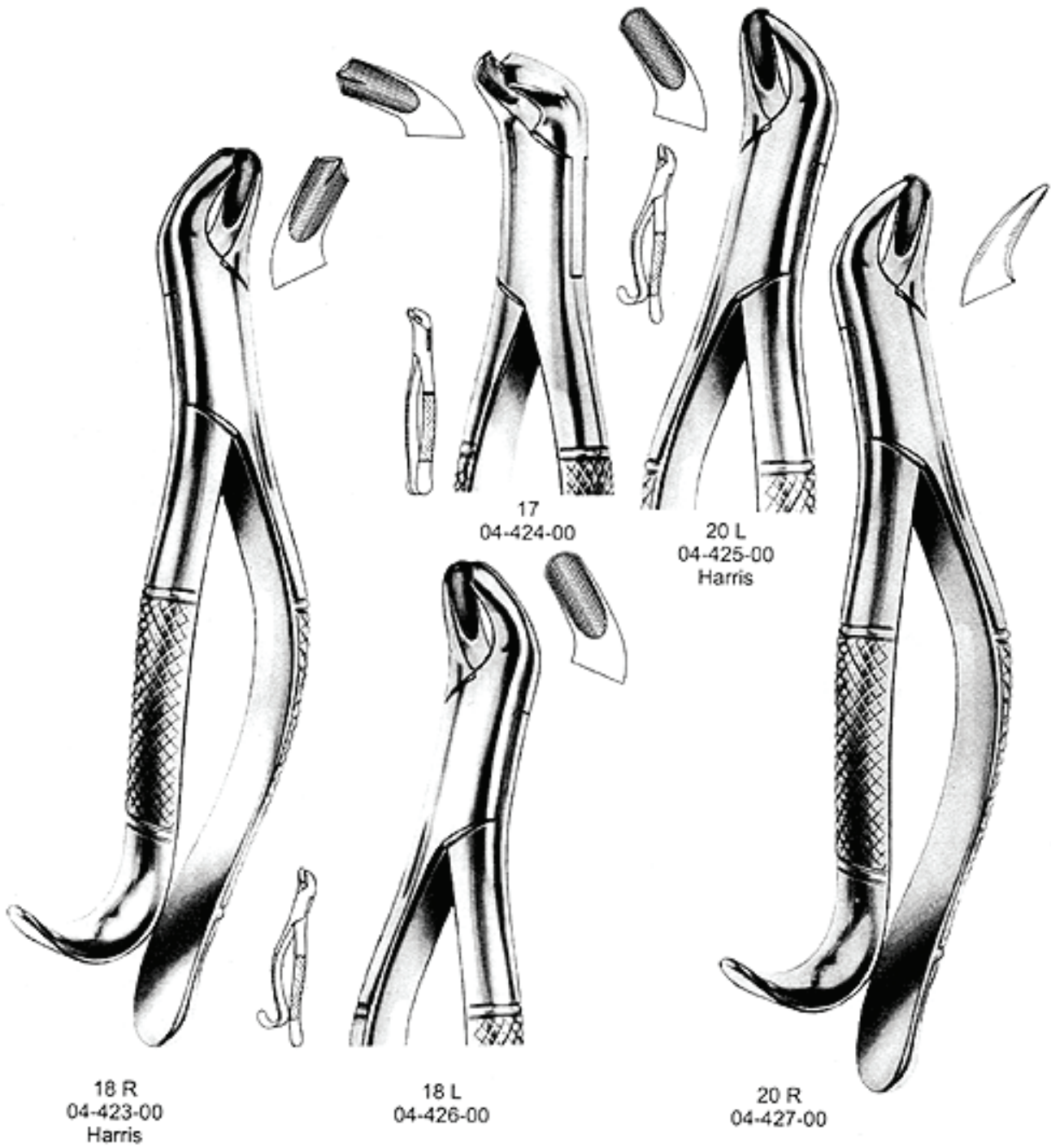



23
04-428-00

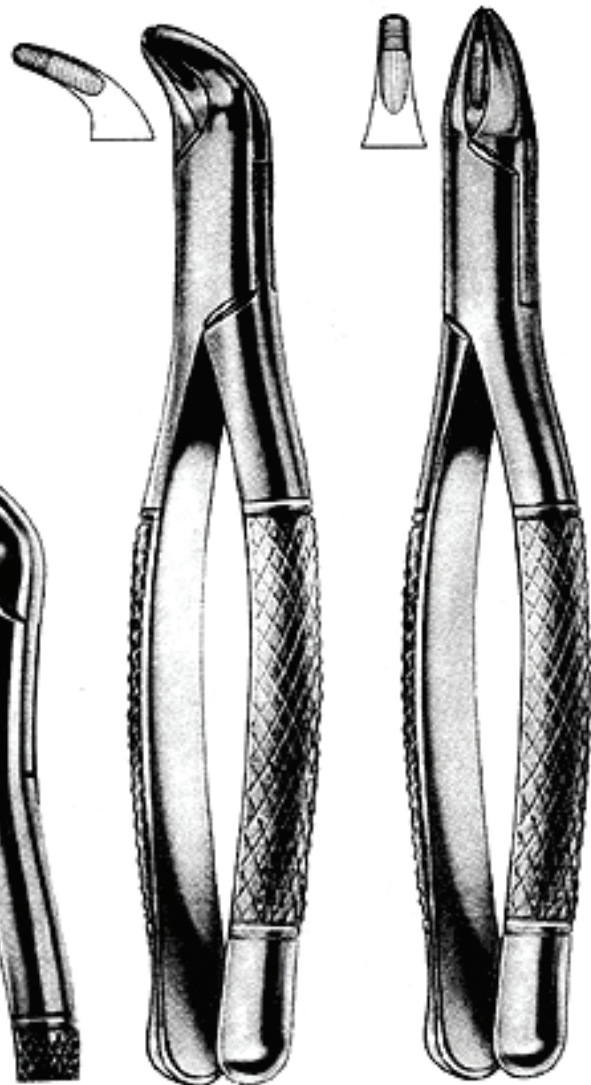

29 S
04-431-00

30 S
04-432-00



24
04-429-00

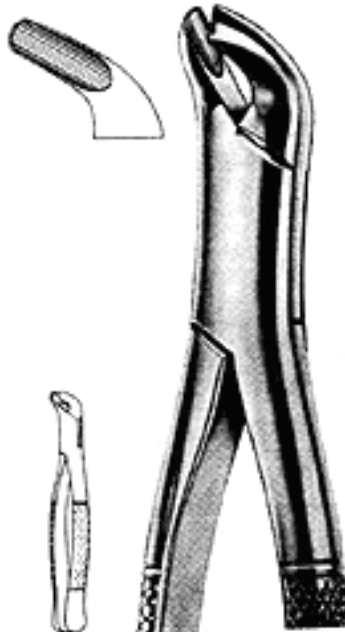

27
04-430-00

EXTRACTING FORCEPS, AMERICAN PATTERN
ZAHNZANGE AMERICAN FORM
FORCEPS DE EXTRACCION FORMA AMERICANA

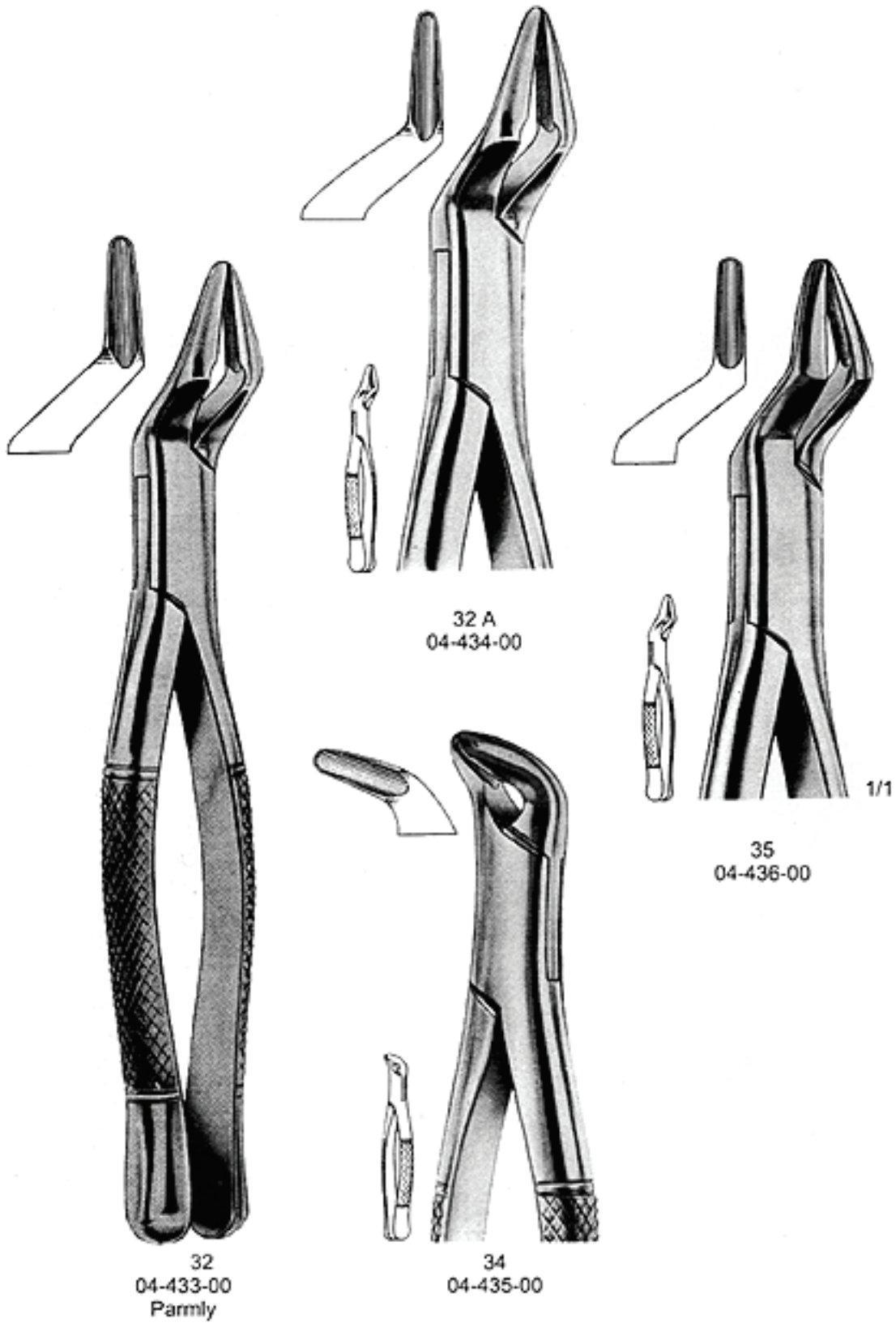

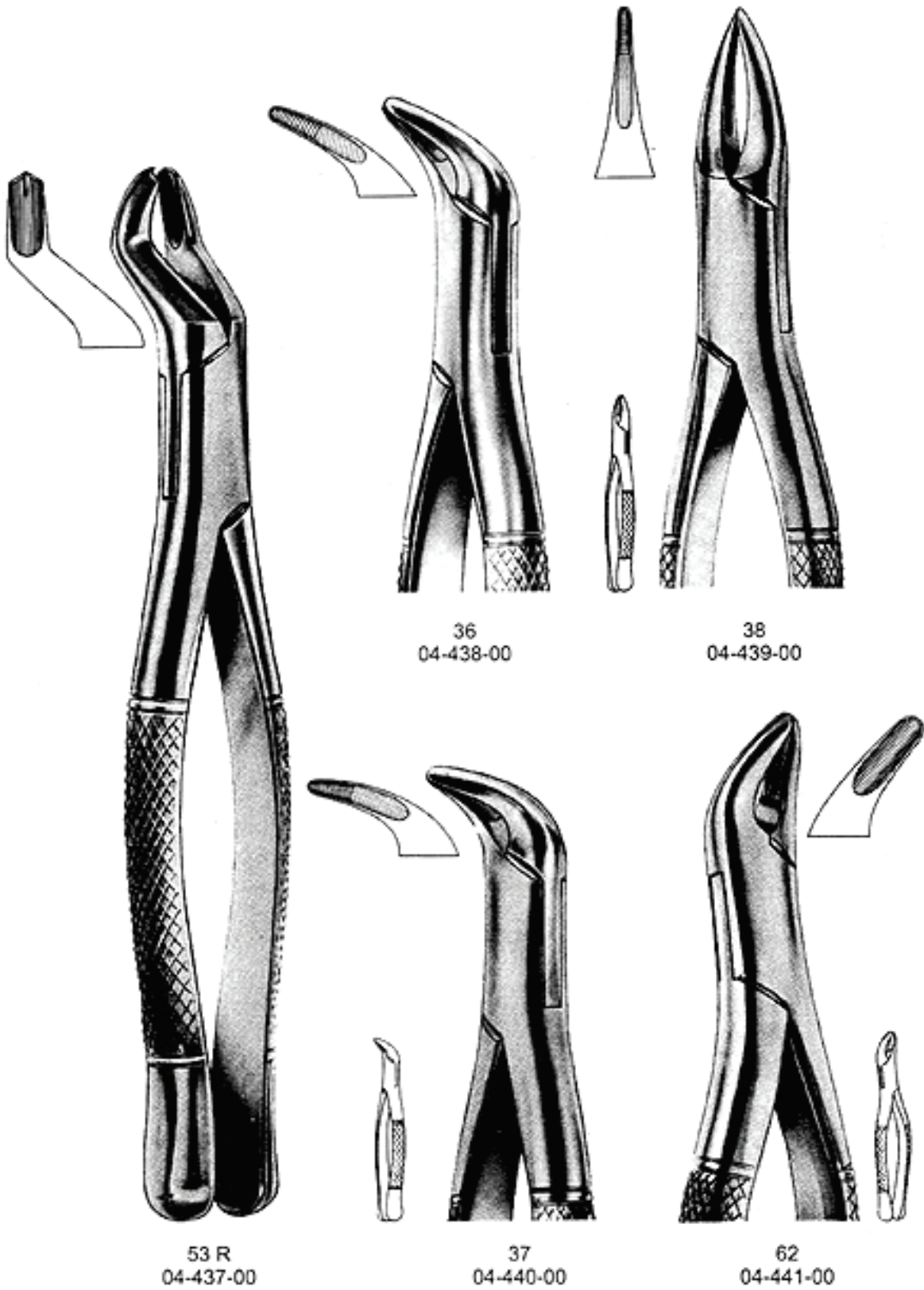

EXTRACTING FORCEPS, AMERICAN PATTERN
ZAHNZANGE AMERICAN FORM
FORCEPS DE EXTRACCION FORMA AMERICANA

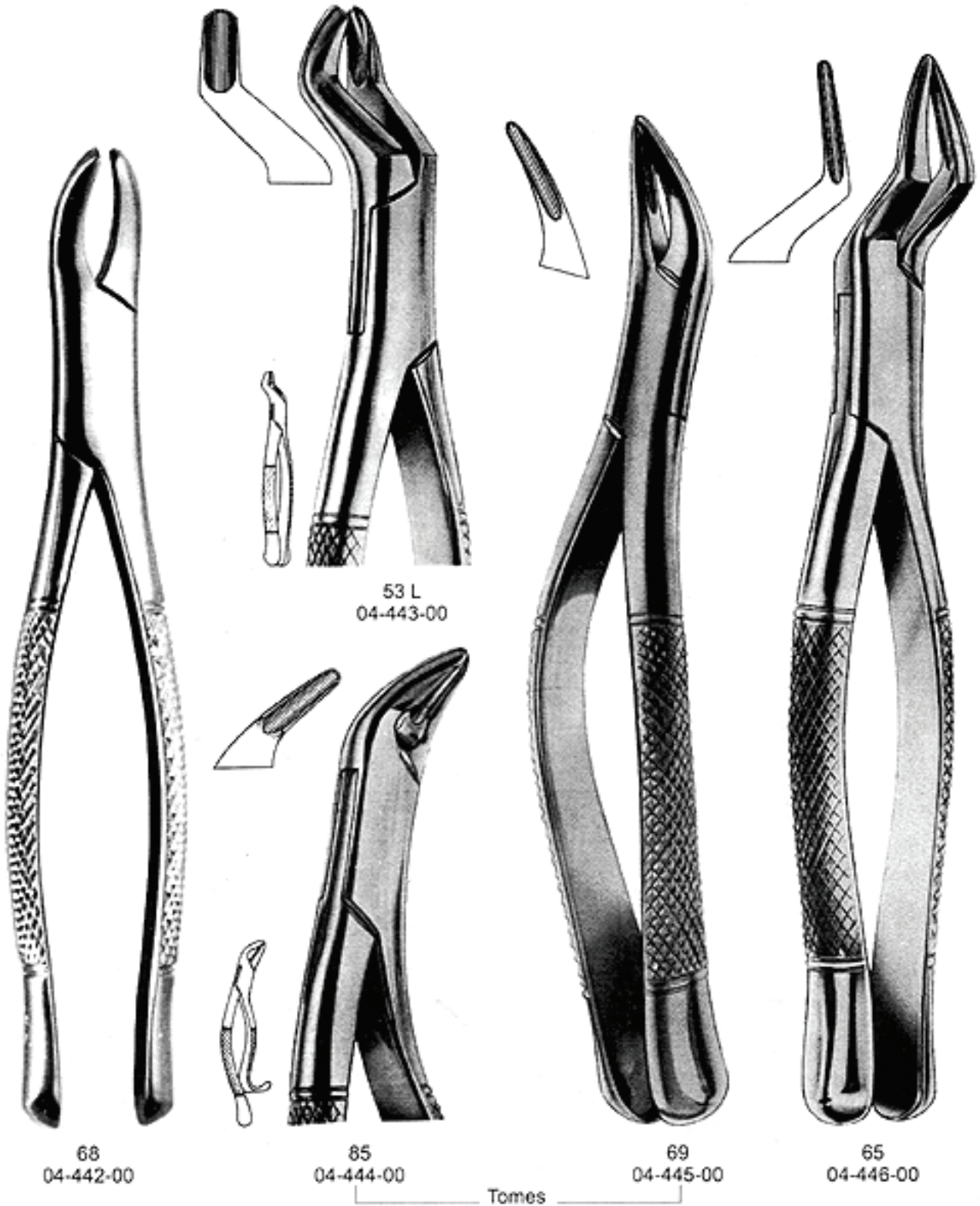

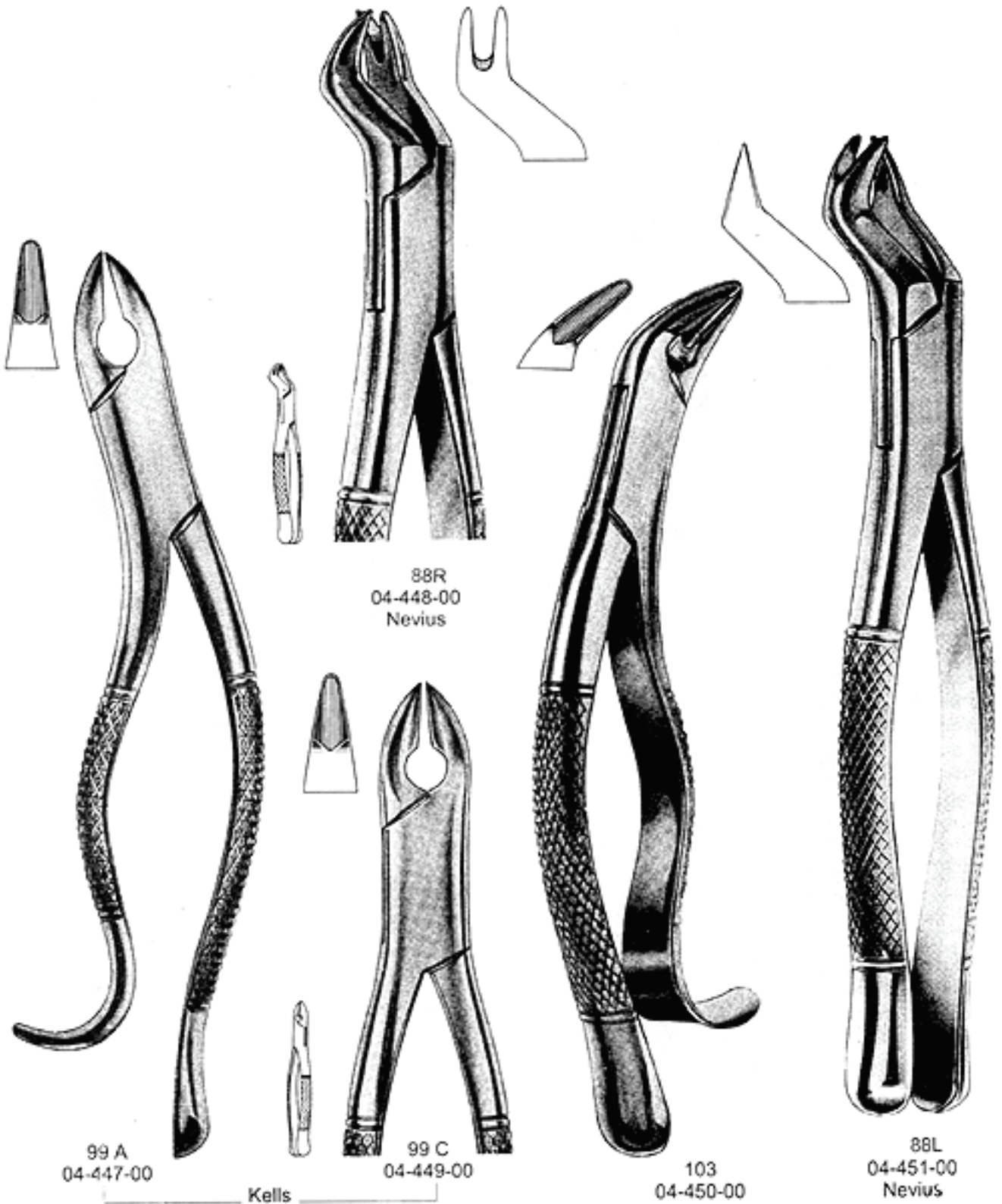

EXTRACTING FORCEPS, AMERICAN PATTERN
ZAHNZANGE AMERICAN FORM
FORCEPS DE EXTRACCION FORMA AMERICANA

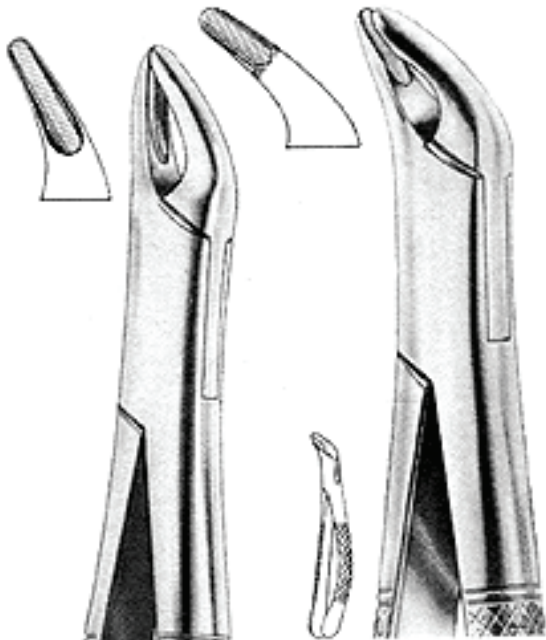

150 A
04-453-00

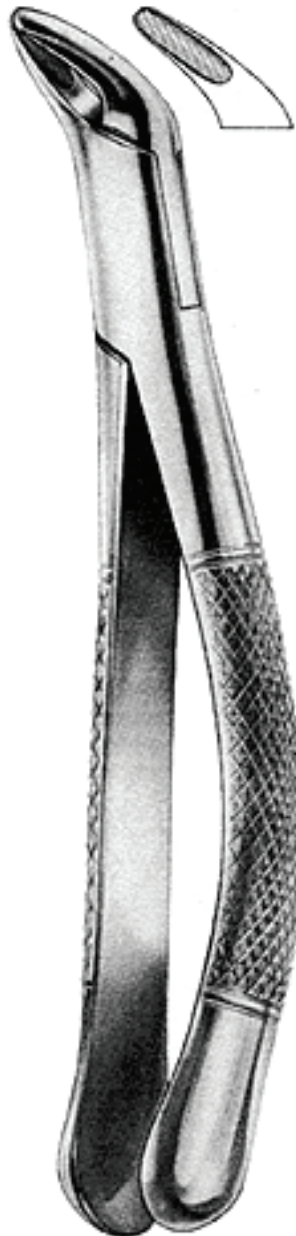

151
04-455-00

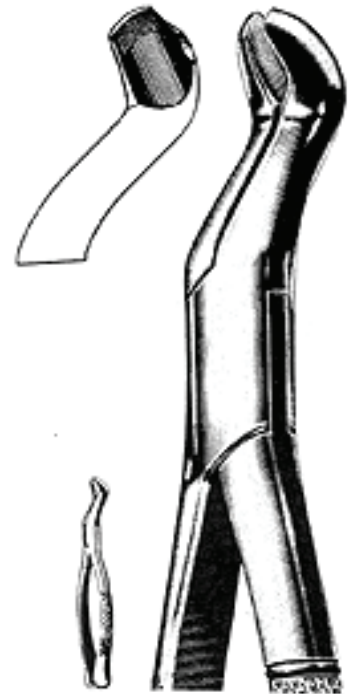

121
04-456-00



150 S
04-452-00

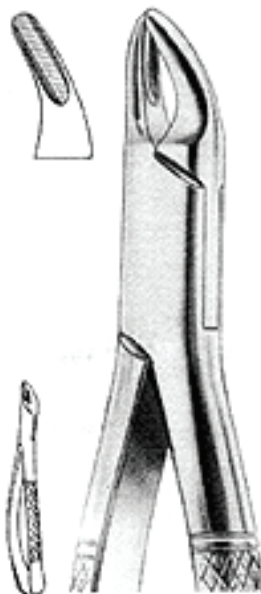

150
04-454-00
cryer

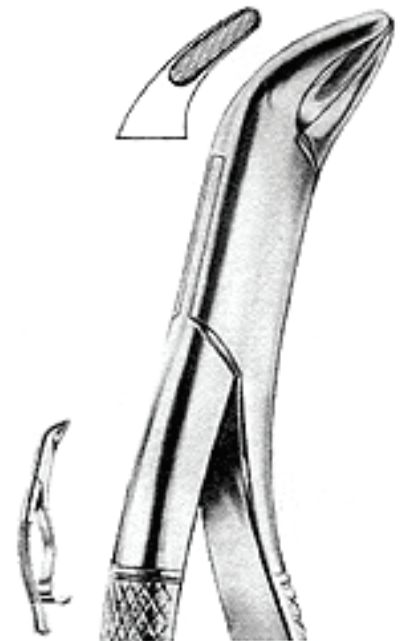

103
04-457-00

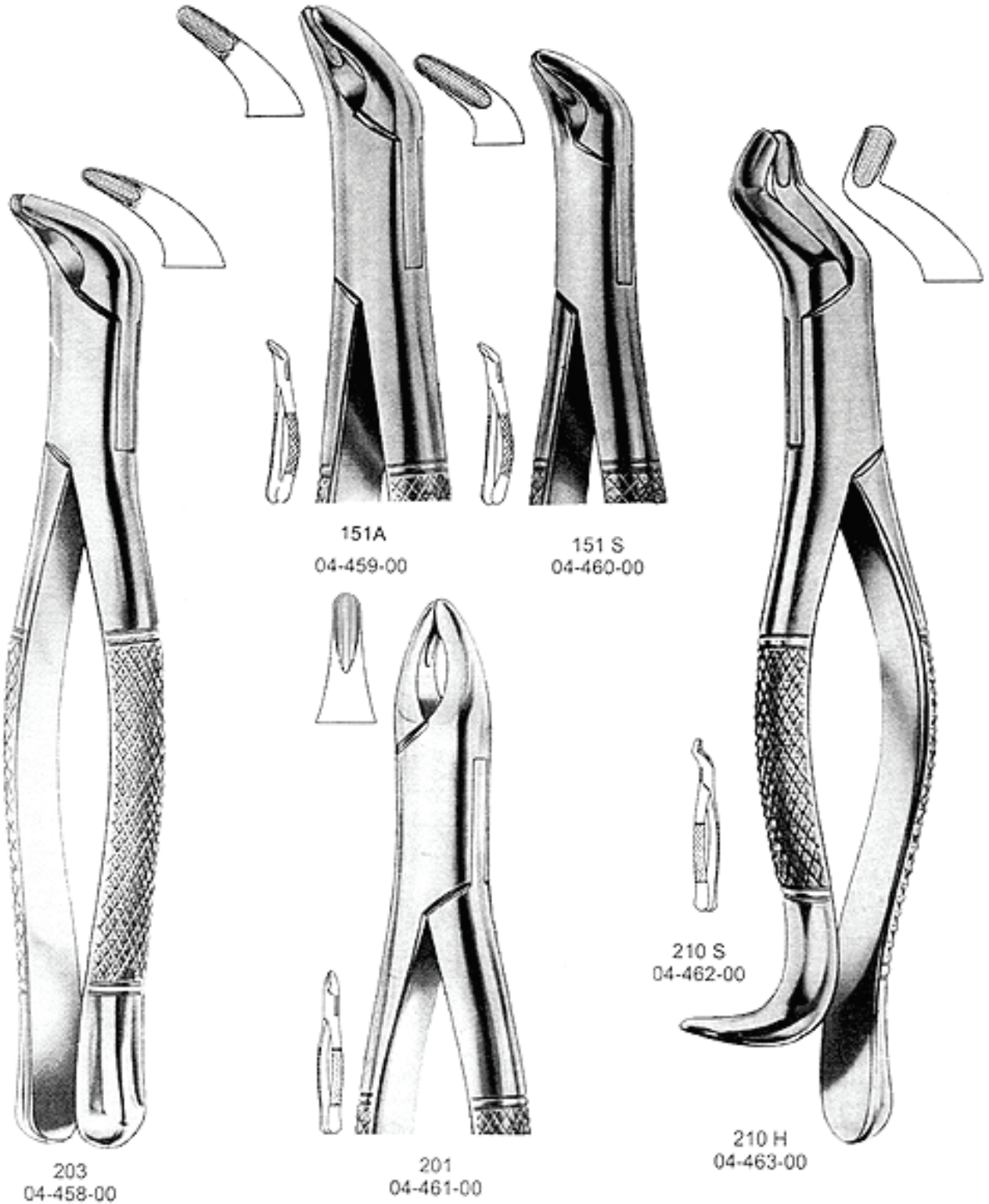

EXTRACTING FORCEPS, AMERICAN PATTERN
ZAHNZANGE AMERICAN FORM
FORCEPS DE EXTRACCION FORMA AMERICANA

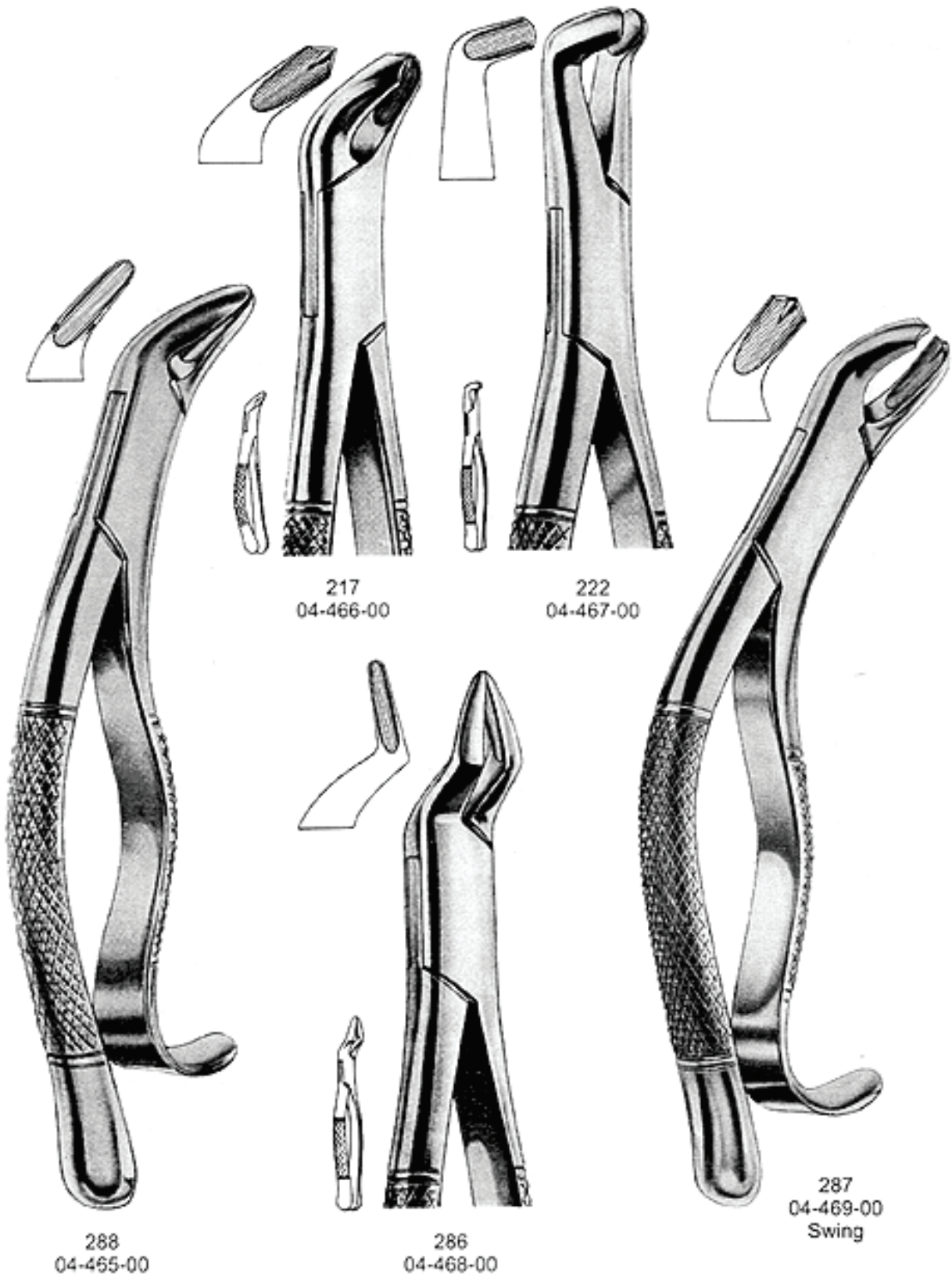

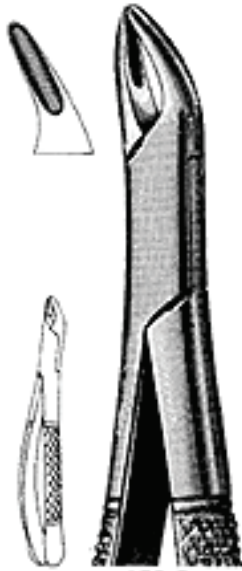

150 S
04-470-00

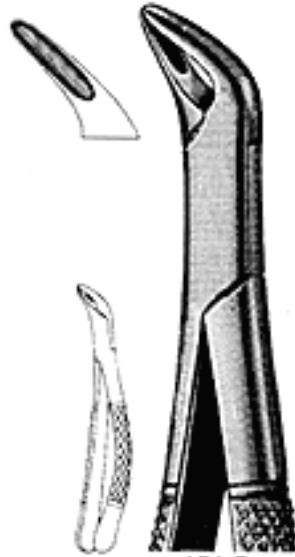

151 S
04-471-00

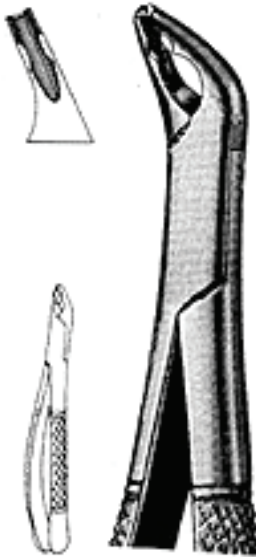

151 XAS
04-473-00

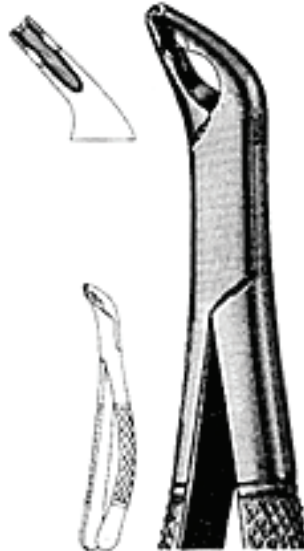

151 XAS
04-473-00

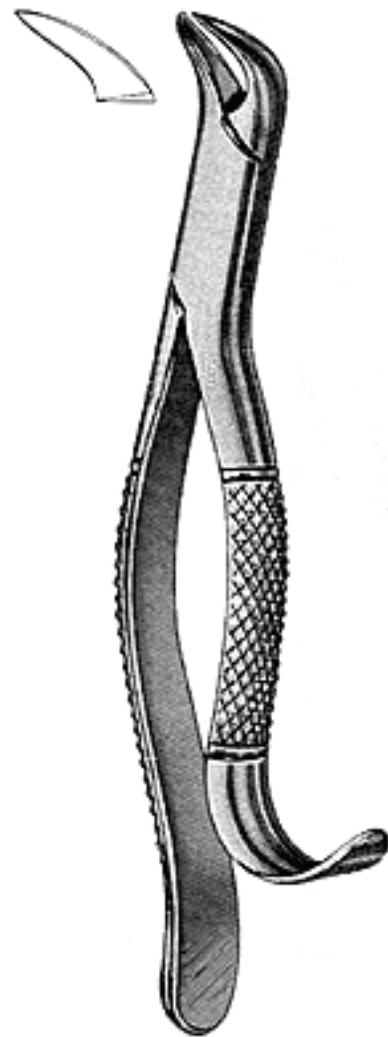

16 S
04-474-00

EXTRACTING FORCEPS, AMERICAN PA TTERN
ZAHNZANGE AMERICAN FORM
FORCEPS DE EXTRACCION FORMA AMERICANA



17 SK
04-475-00



23 SK
04-477-00

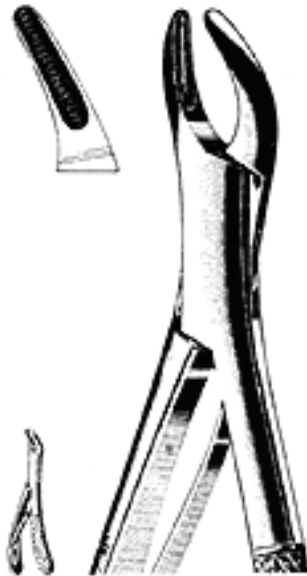

150 SK
04-476-00

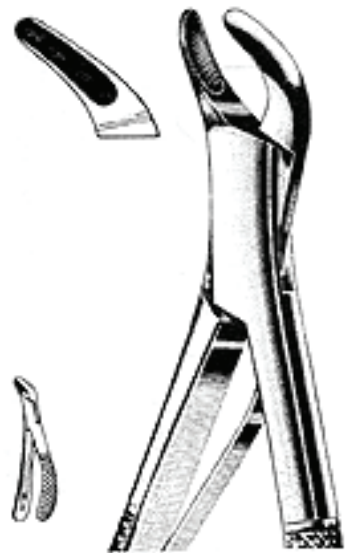

151 SK
04-478-00

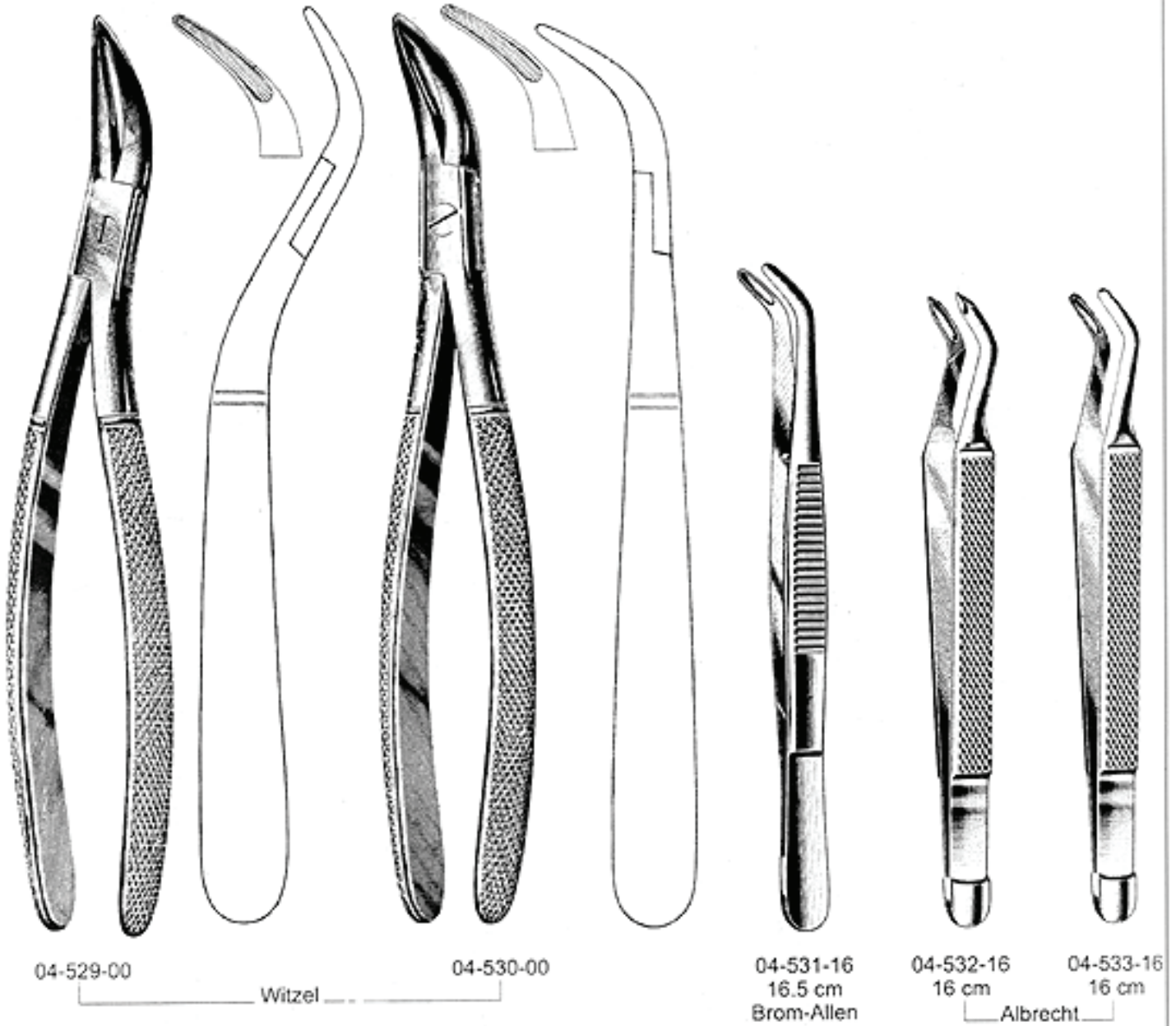
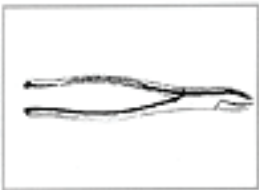



1
04-584-00



99
04-585-00



04-586-00

**WITH DIAMOND
DUST COATING**



**WITH DIAMOND
DUST COATING**

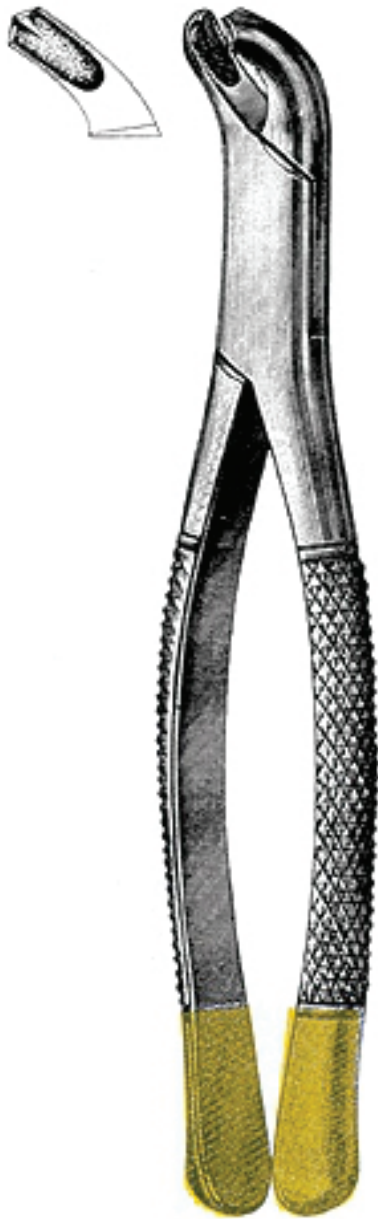

17
04-587-00

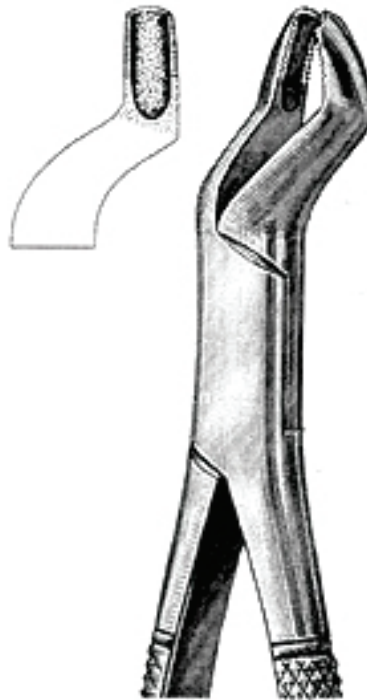

53 L
04-588-00

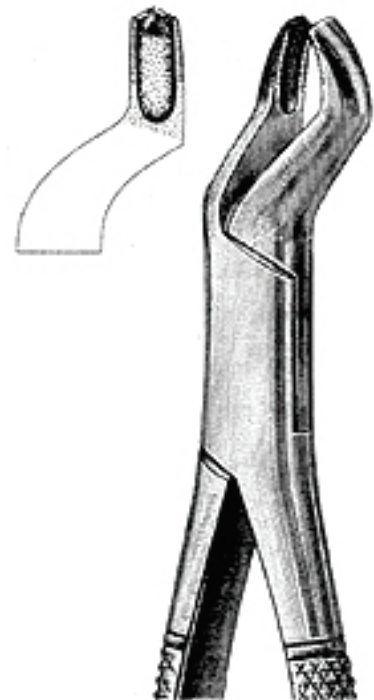

53 R
04-589-00

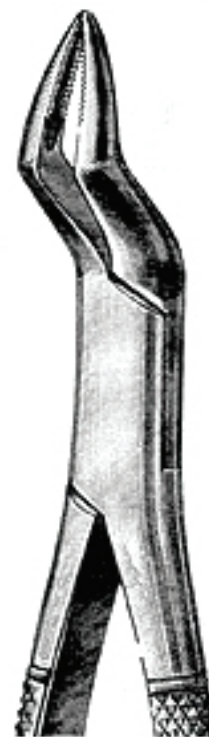

65
04-590-00



WITH DIAMOND DUST COATING

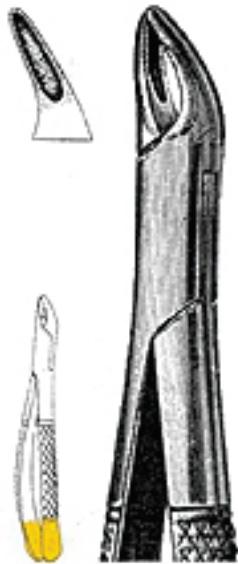

150 S
04-591-00

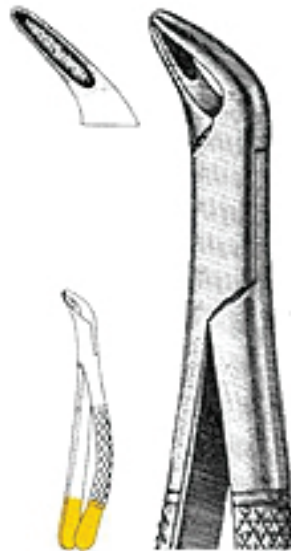

151 S
04-592-00

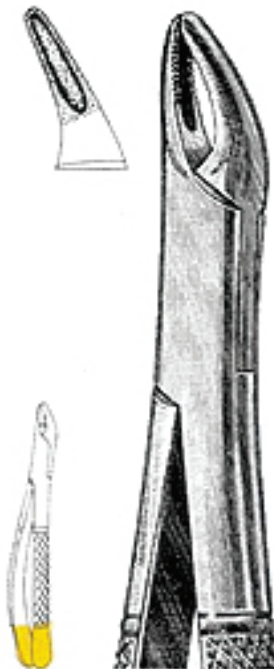

150
04-593-00



151
04-594-00

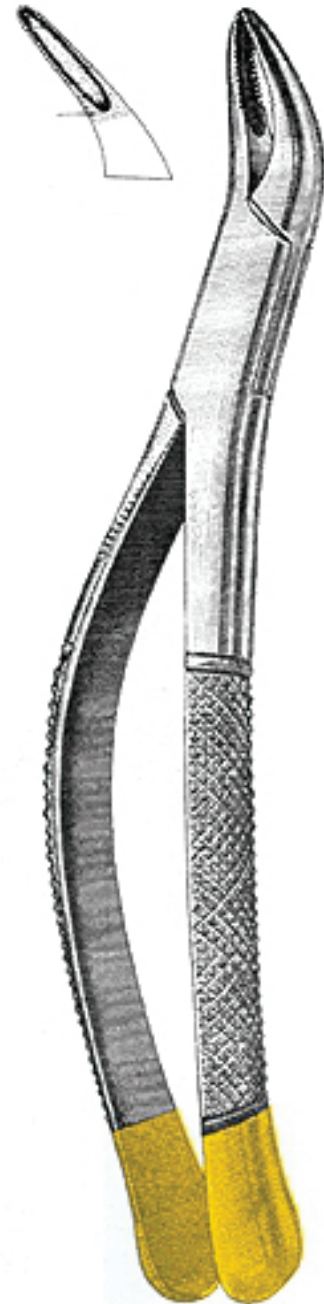

69
04-595-00

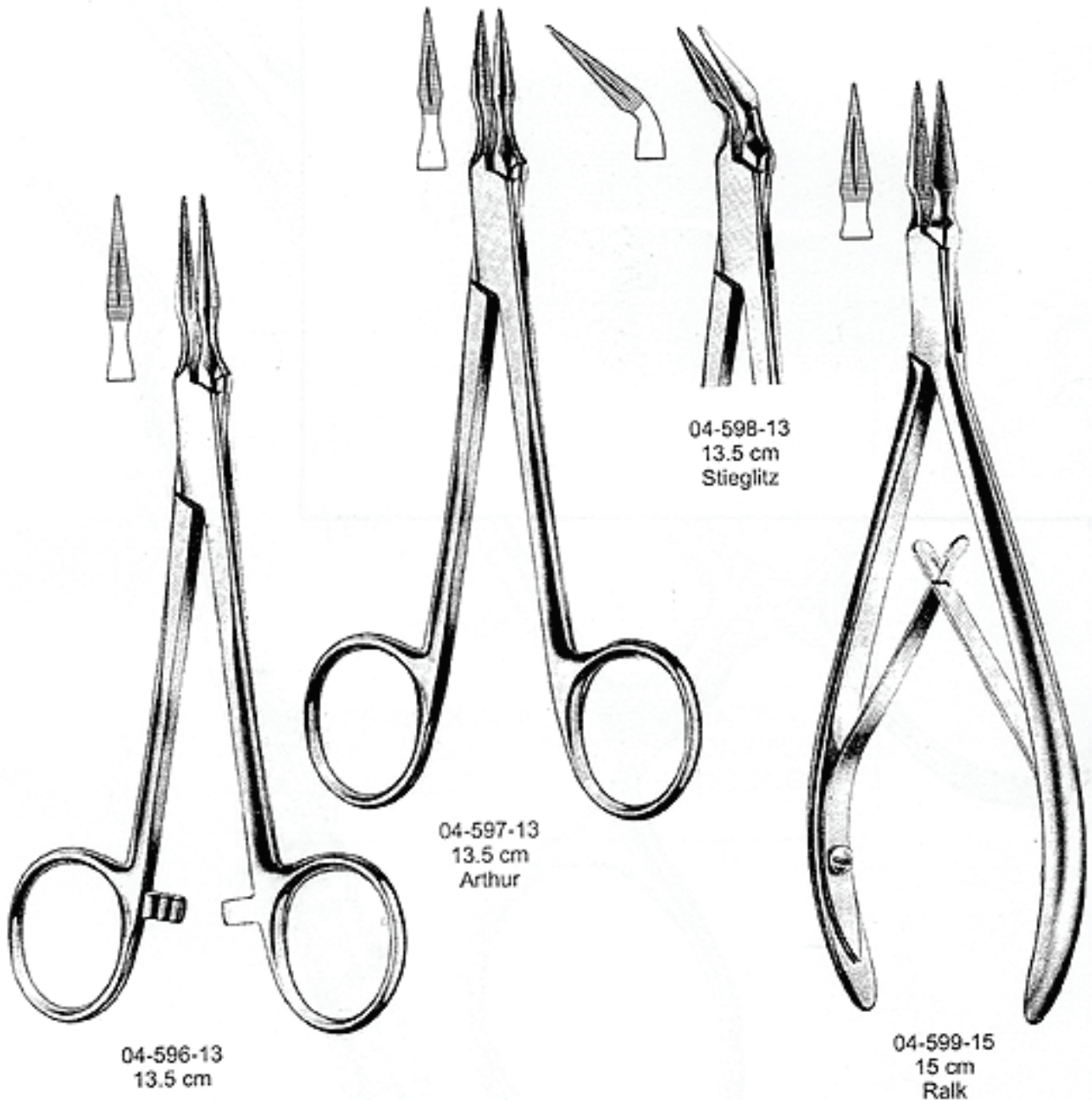
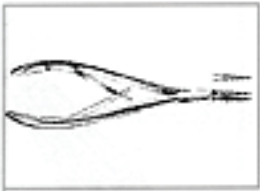

Department

05

PERIODONTAL INSTRUMENTS
INSTRUMENTE FÜR DIE PARODONTOLOGIE
INSTRUMENTOS PARA PERODONCIA

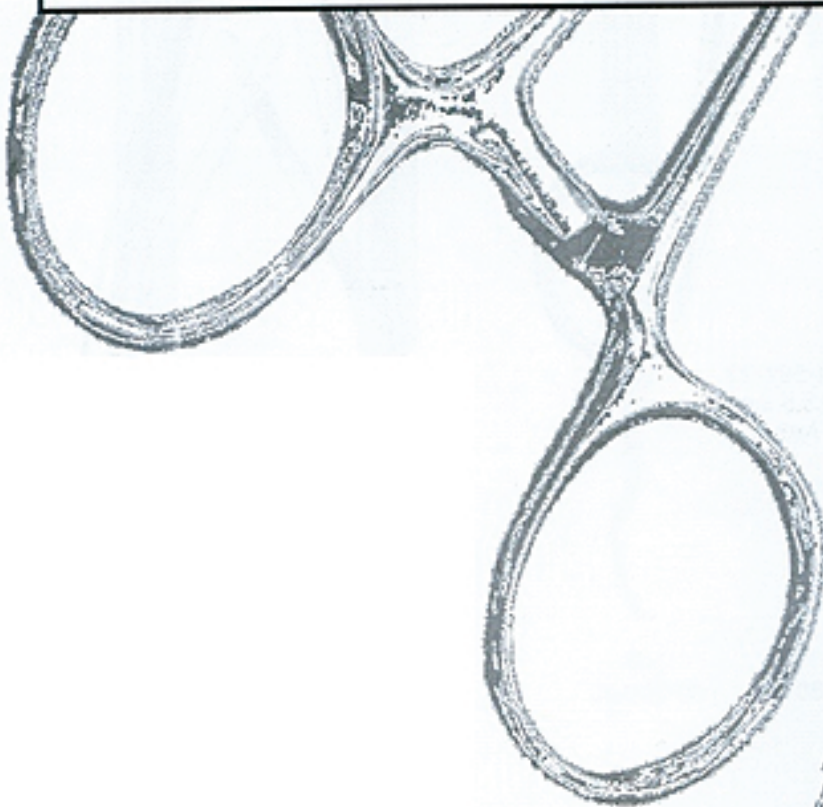
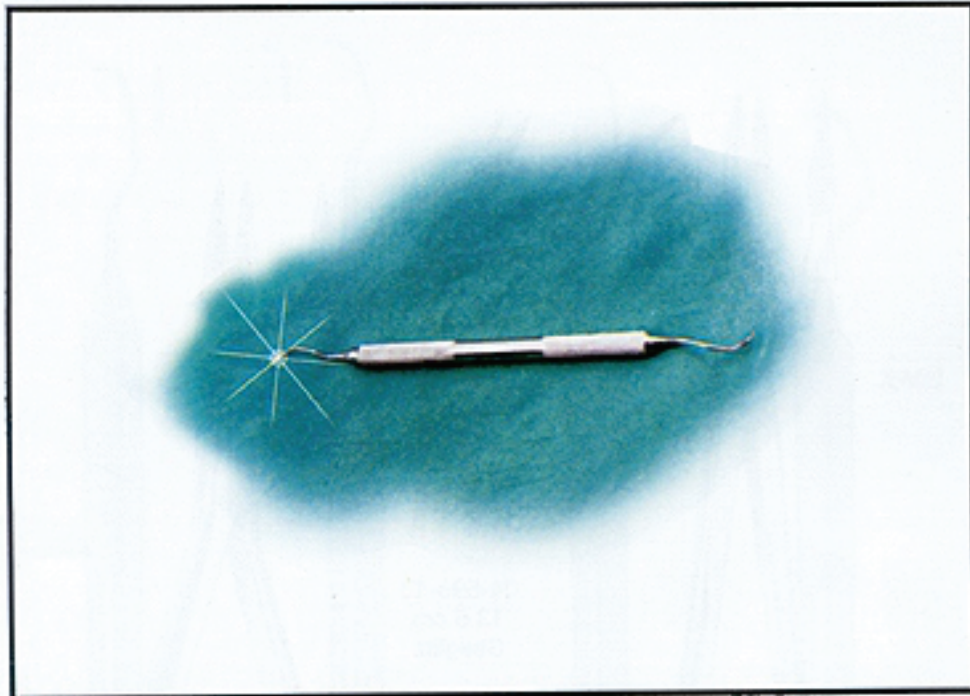



AA
 OCTA-Classic
 Solid handle Ø5.5 mm



BB
 SLIM-Action
 Solid handle Ø6 mm



CC
 COBRA-Series
 Hollow handle Ø8 mm



DD
 RING-O-Lite
 Hollow handle Ø8 mm



EE
 FEATHER Feel
 Hollow handle Ø8 mm



FF
 SOFTHOLD
 Hollow handle Ø8 mm



GG
 MAX GRIP
 (For detail: Please read catalogue page no. 133)

NOTE: Any one of the above handles can be chosen for hand instruments just by given reference of any required HANDLE.

PERIODONTAL INSTRUMENTS
INSTRUMENTE FÜR DIE PARODONTOLOGIE
INSTRUMENTSOS PARA PERODONCIA

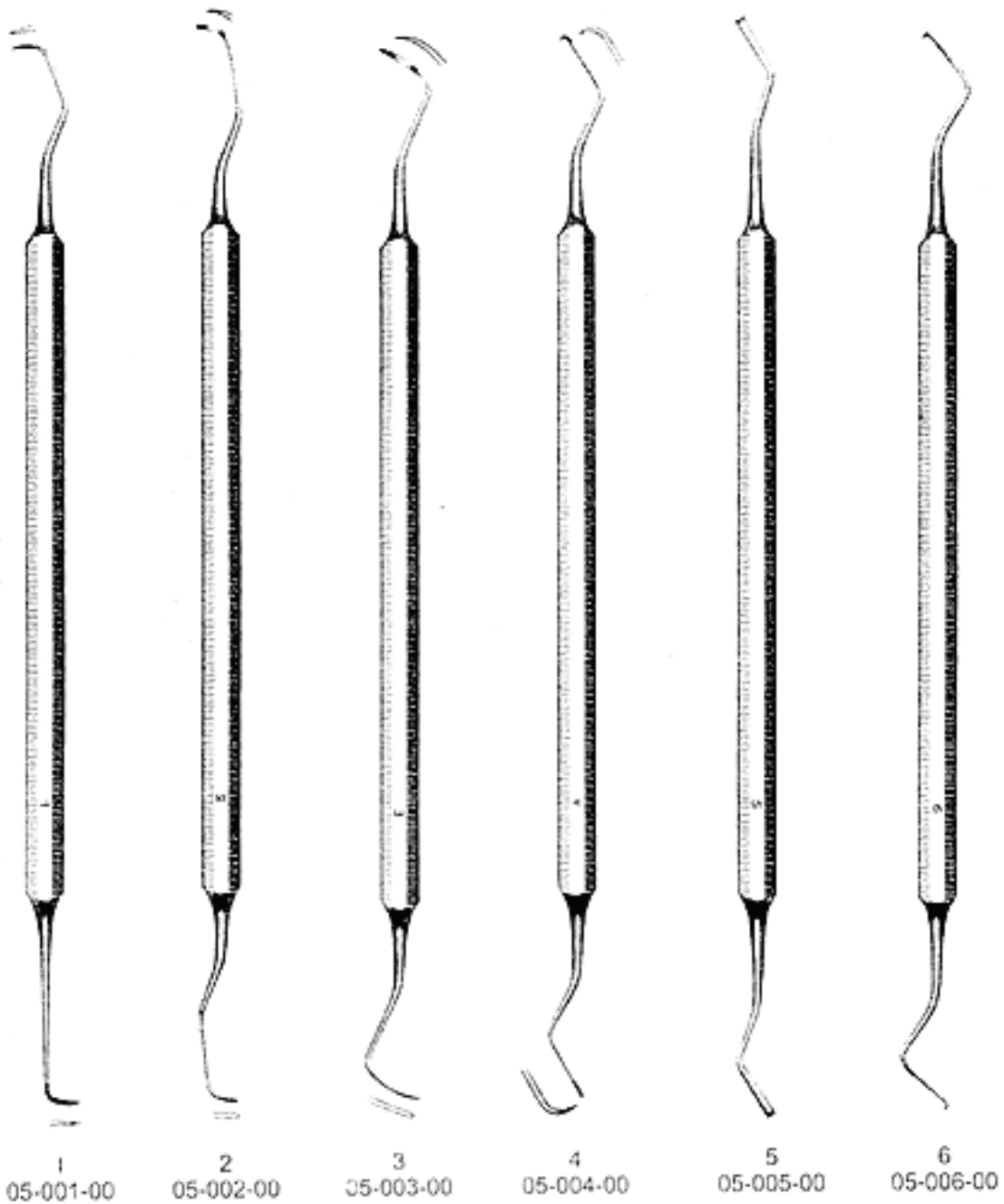
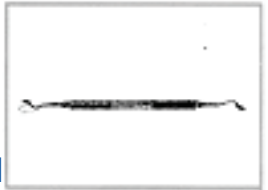

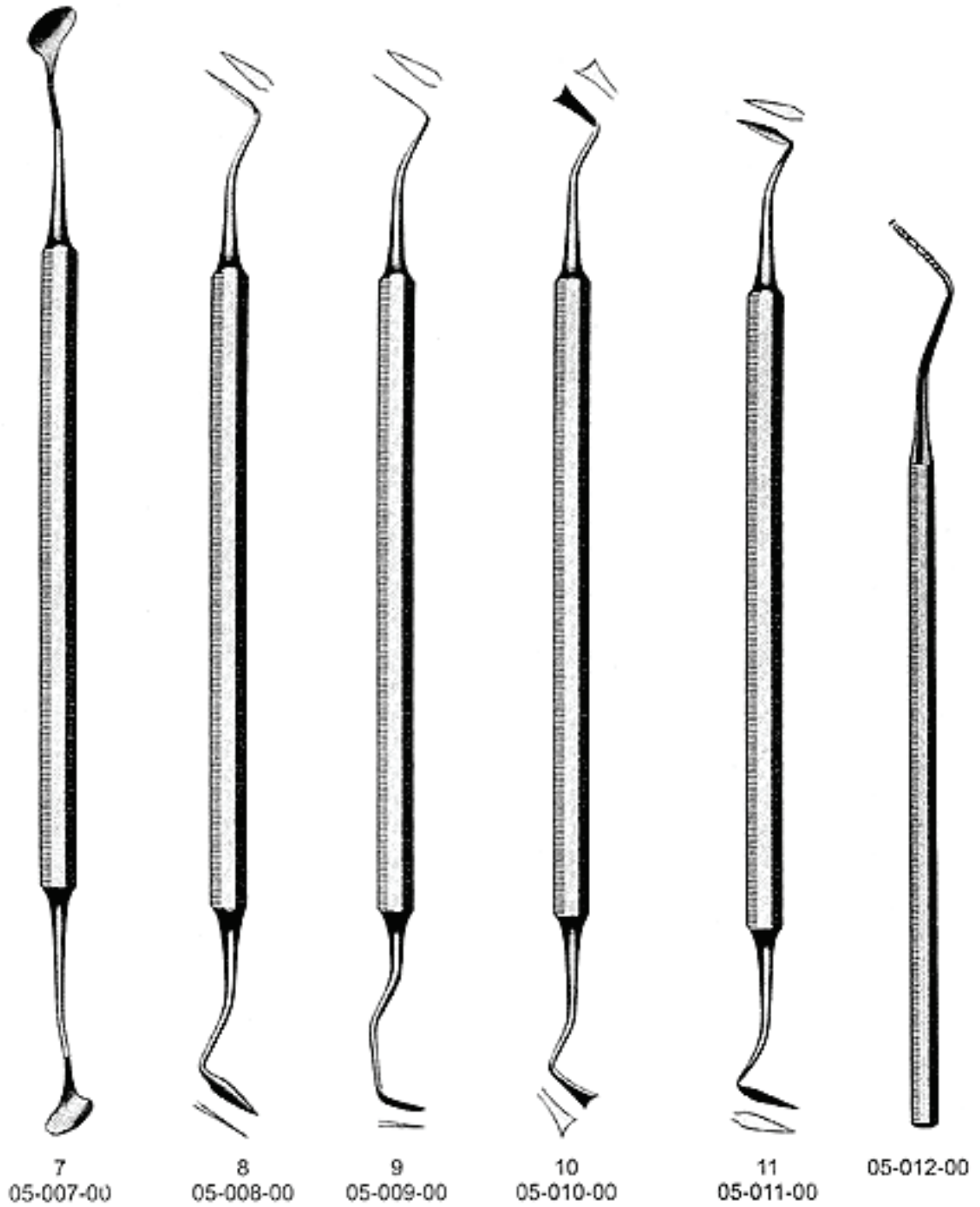

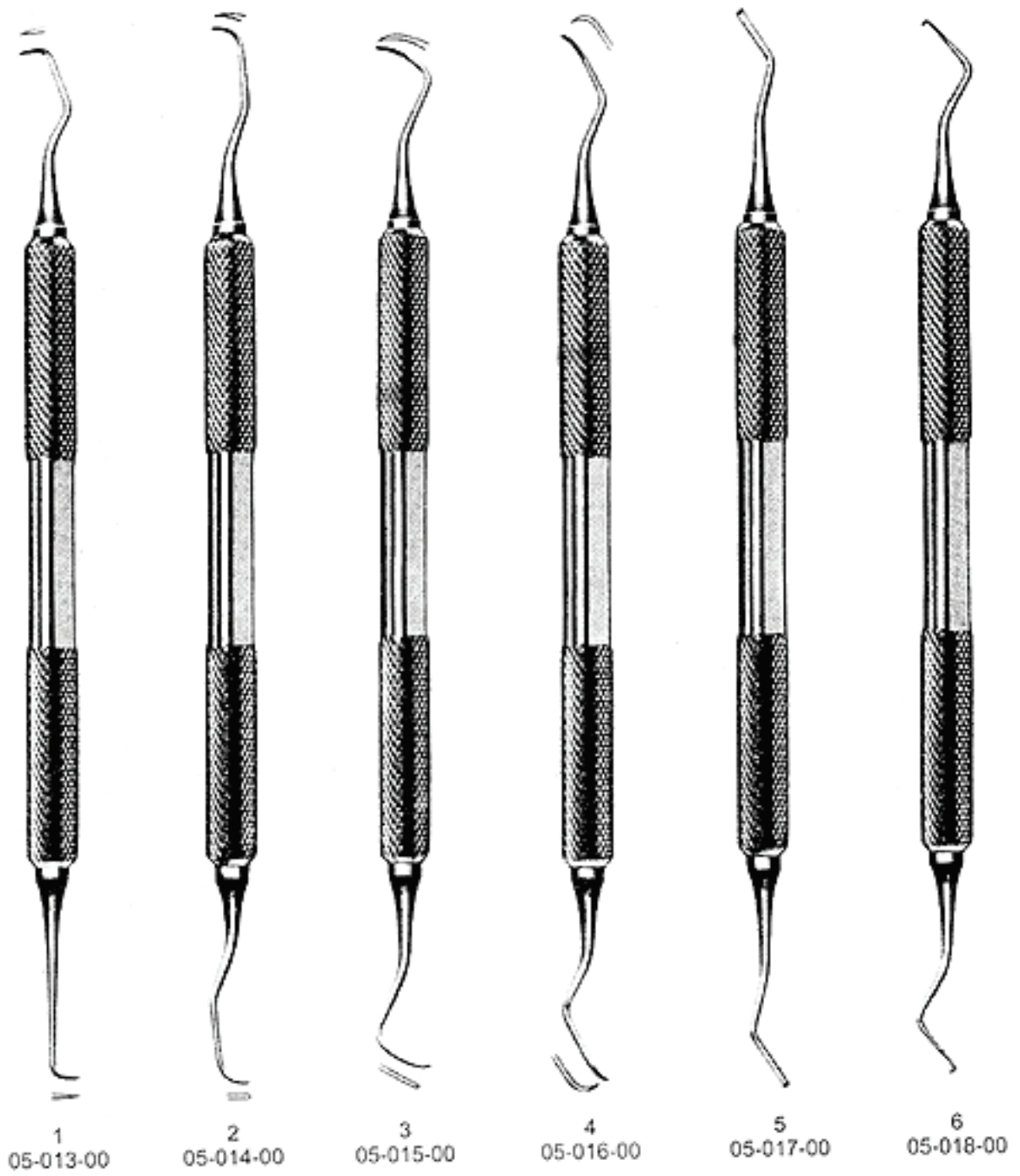

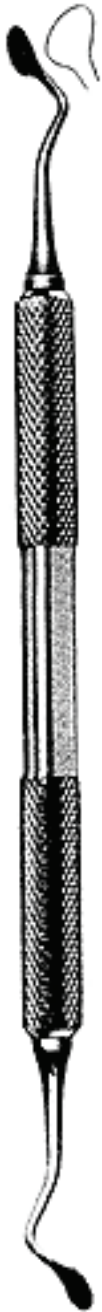

7
05-019-00

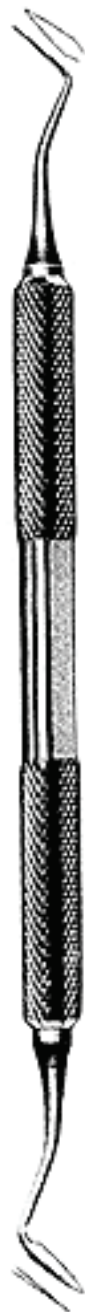

8
05-020-00



9
05-021-00



10
05-022-00

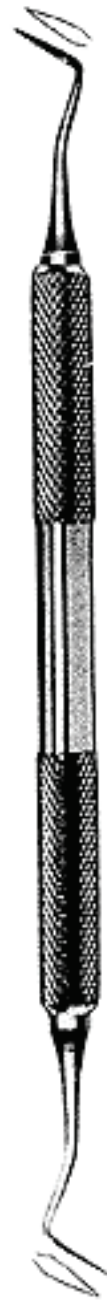

11
05-023-00

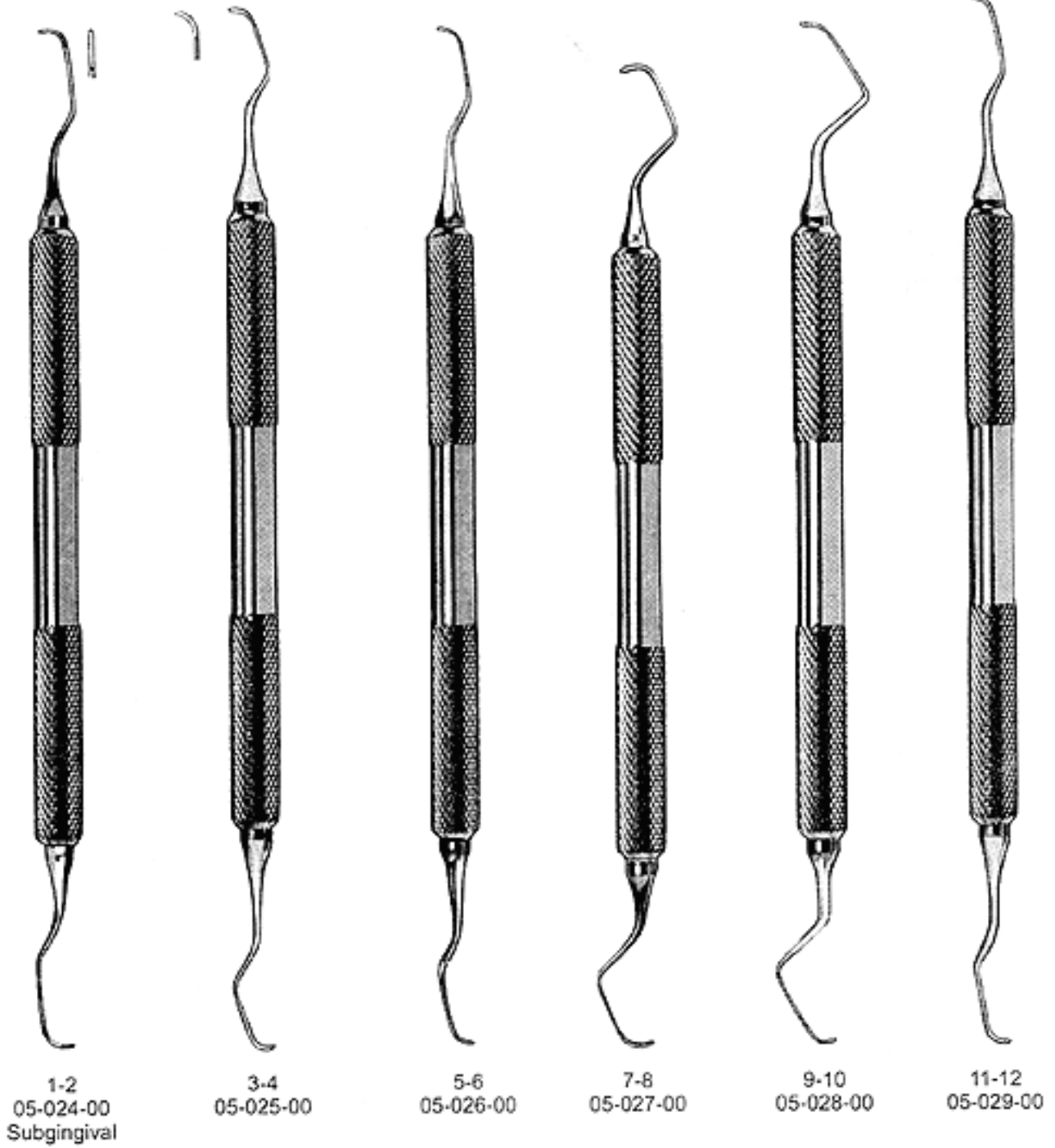

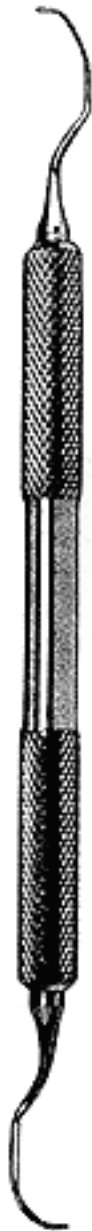

13-14
05-030-00

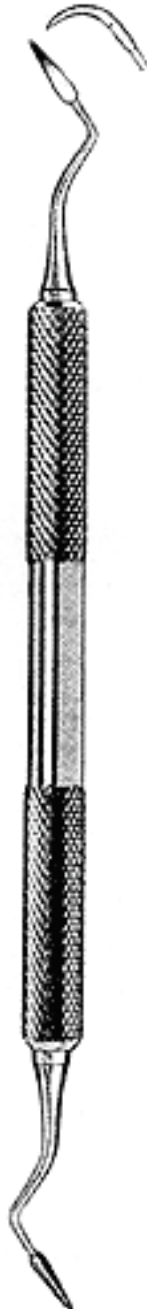

CK 6
05-031-00
Crane-Kaplan



H6-H7
05-032-00

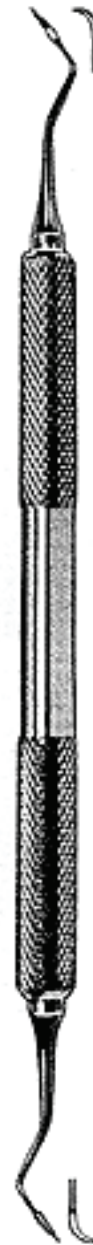

T2-T3
05-033-00
Taylor

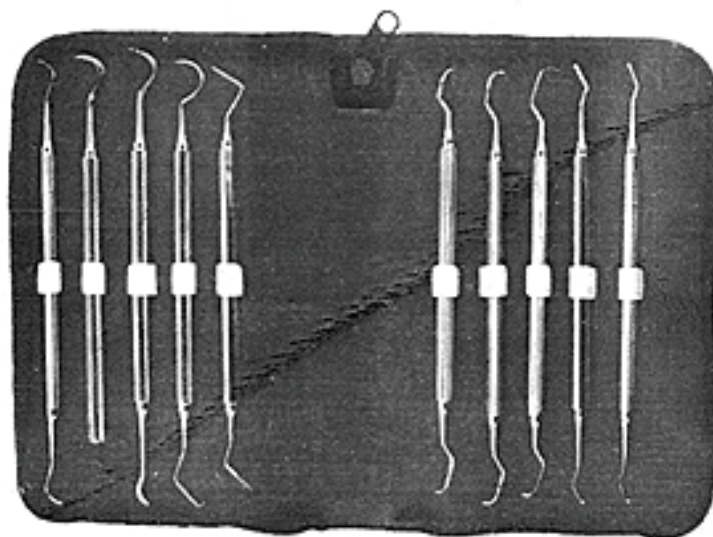

05-034-00

Subgingival CuretteSet Consisting Of: 10 Pieces

- 1- Goldman fox pocket probe, double ended.
- 1- Explorer, double ended # 5
- 1- Jaquette scaler, single ended # 15
- 1- Jaquette scaler, double ended, # U 15/33
- 1- McCall curette, double ended, # 17S/18S
- 1- Langer curette, double ended # L 1/2
- 1- Langer curette, double ended # L 3/4
- 1- Langer curette, double ended # L 5/6
- 1- Periodontal curette, double ended, # H 3/7
- 1- Periodontal curette, double ended, # H 5/11

Department

06

SCALERS
ZAHNREINIGER
LIMPIADORES DE SARRO

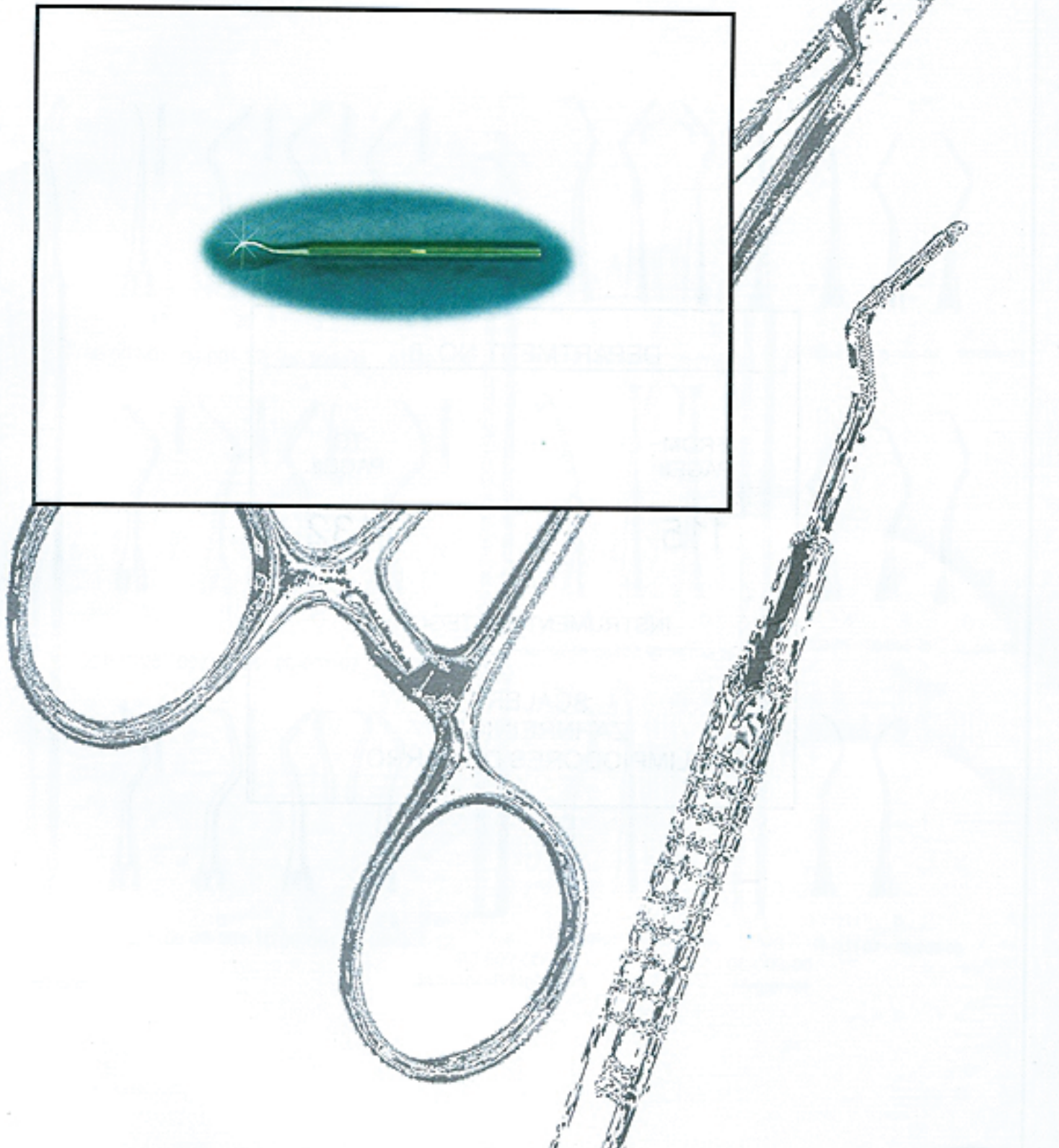

DEPARTMENT NO. 6

FROM
PAGE#

115

TO
PAGE#

132

INSTRUMENTS CATEGORY

SCALERS
ZAHNREINIGER
LIMPIADORES DE SARRO

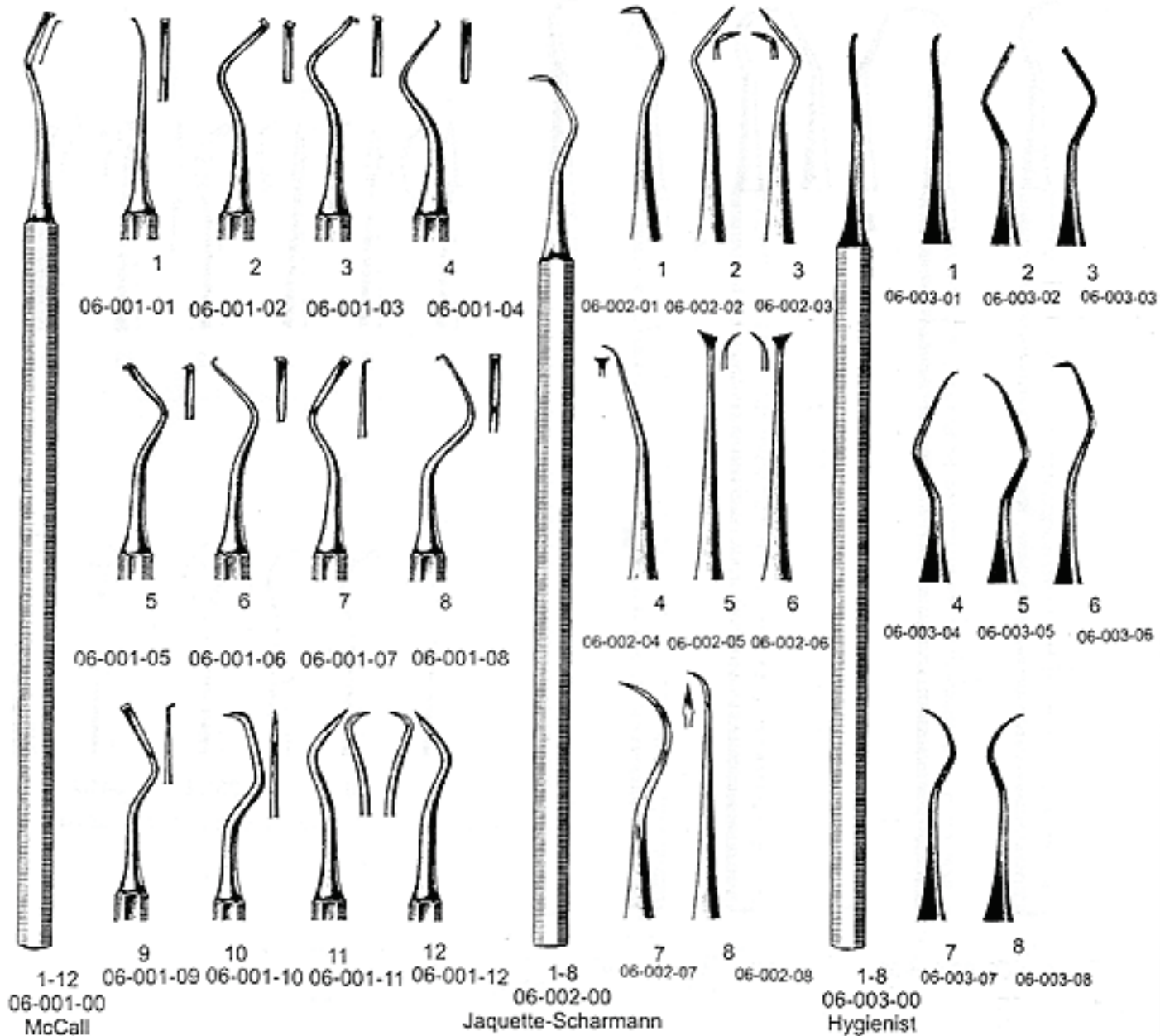

SCALERS
ZAHNREINIGER
LIMPIADORES DE SARRO

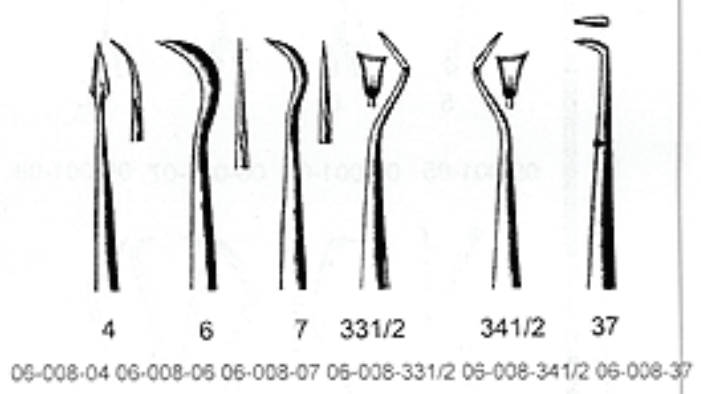
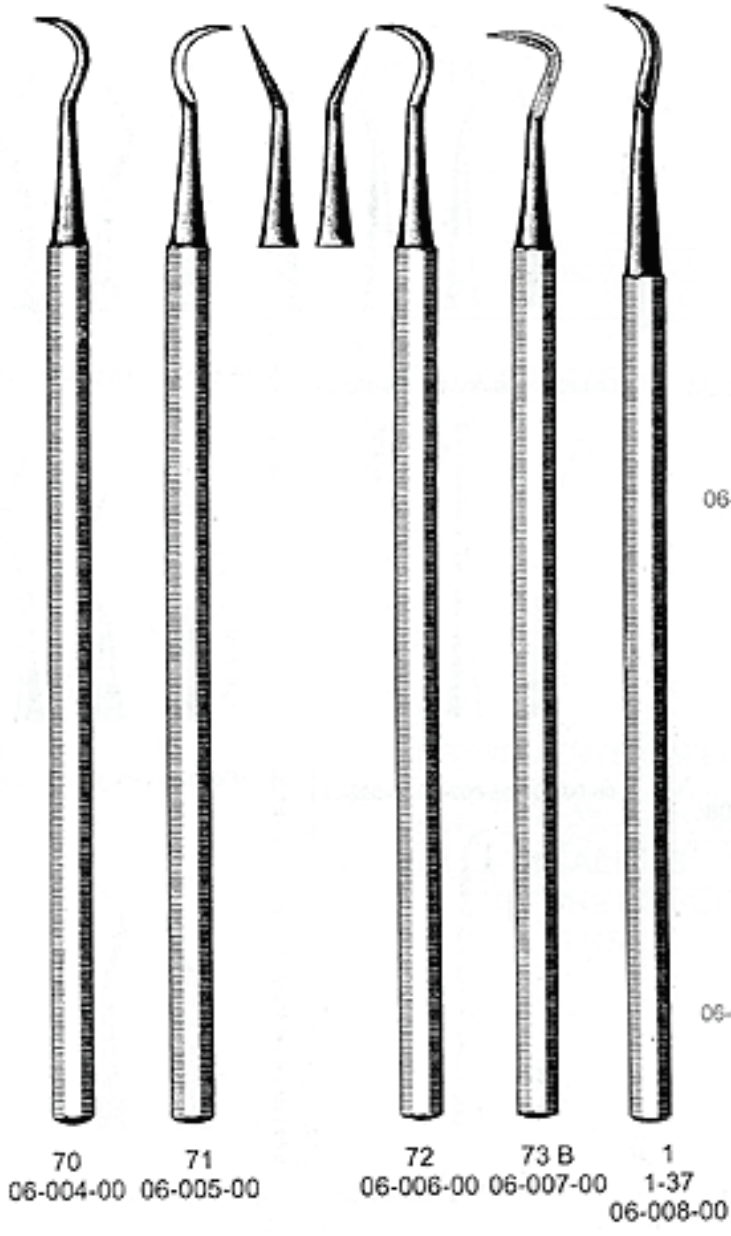

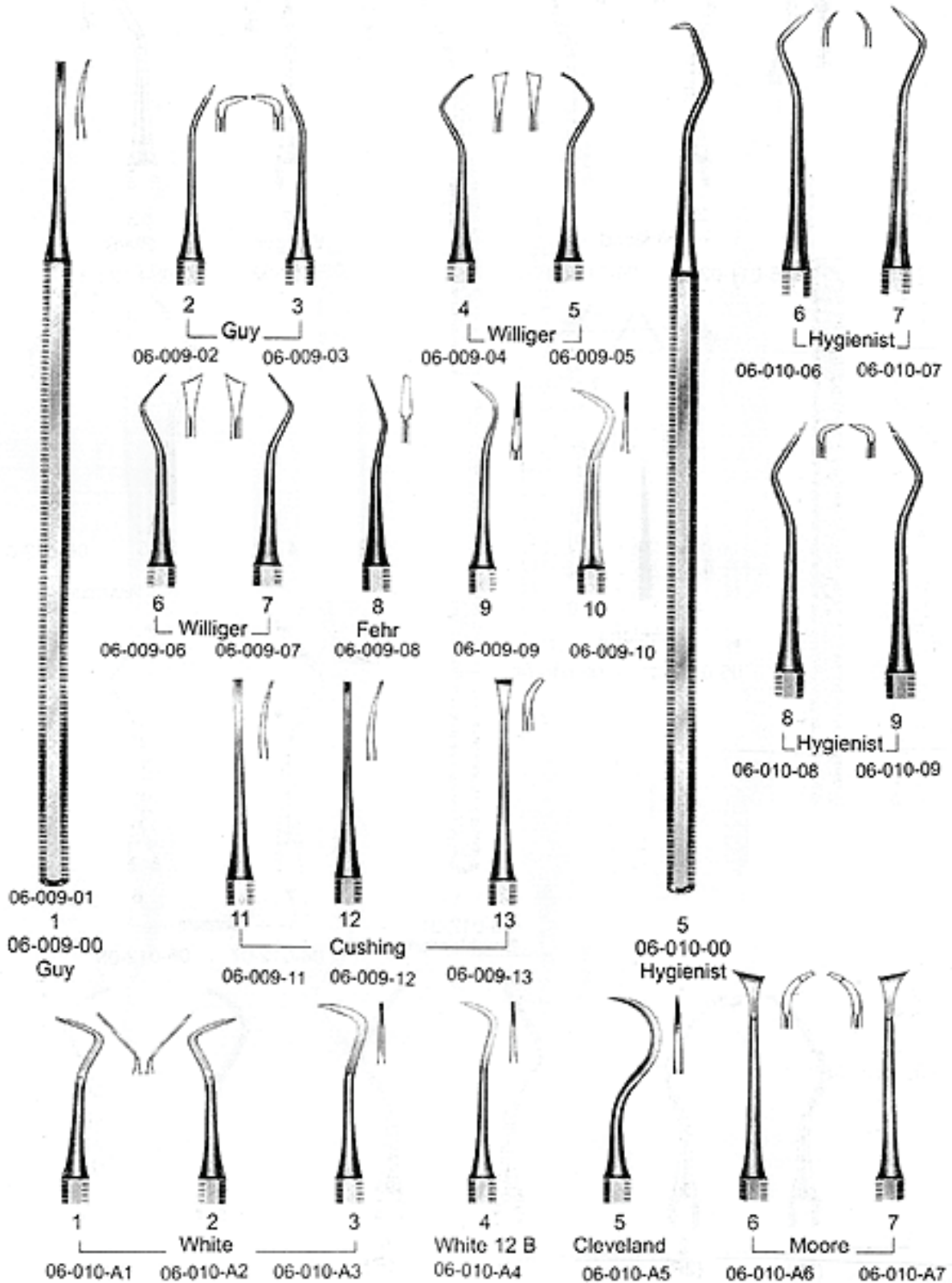

SCALERS
INSTRUMENTS A DETARTRER
LIMPIODORES DE SARRO

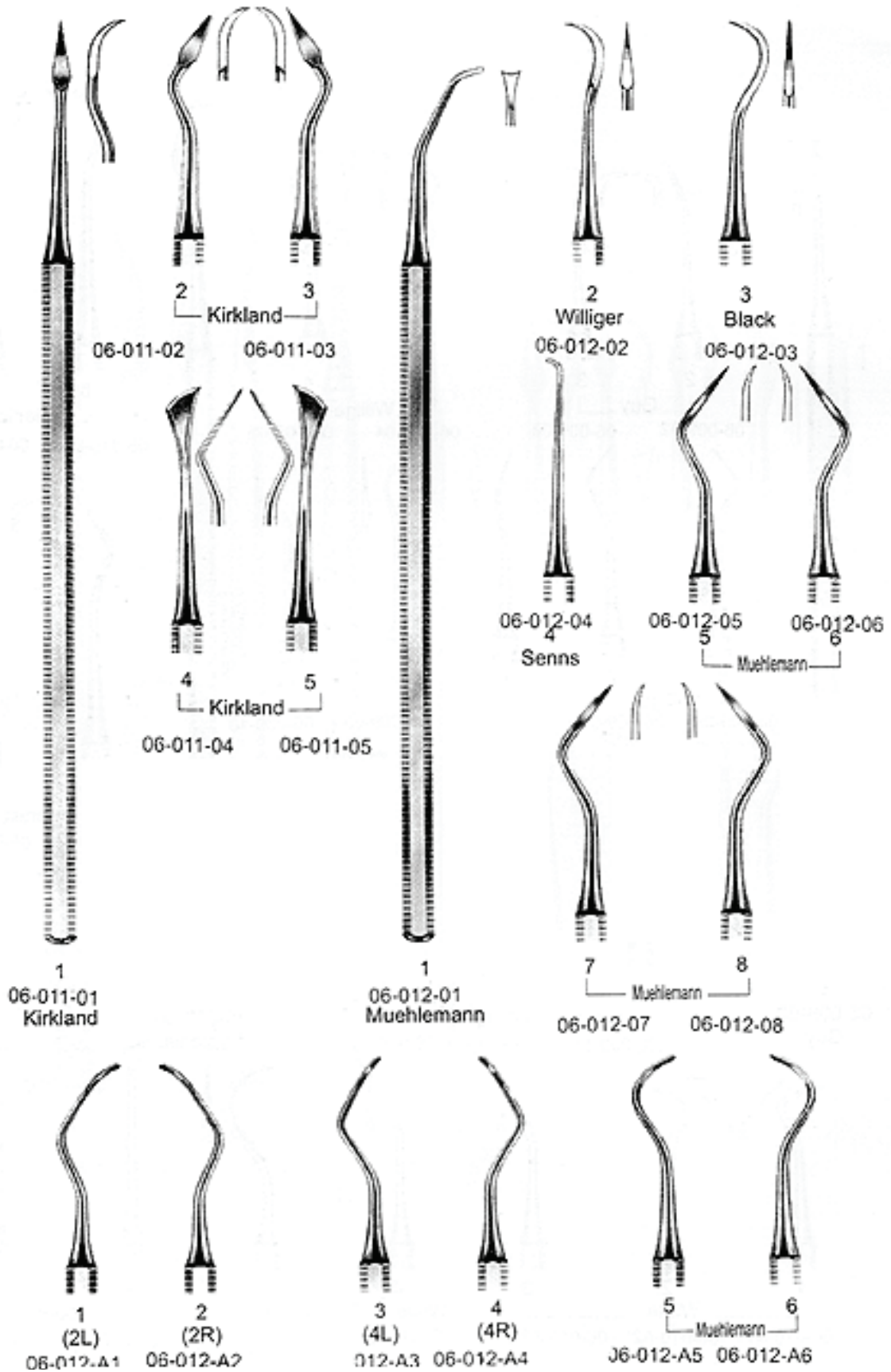

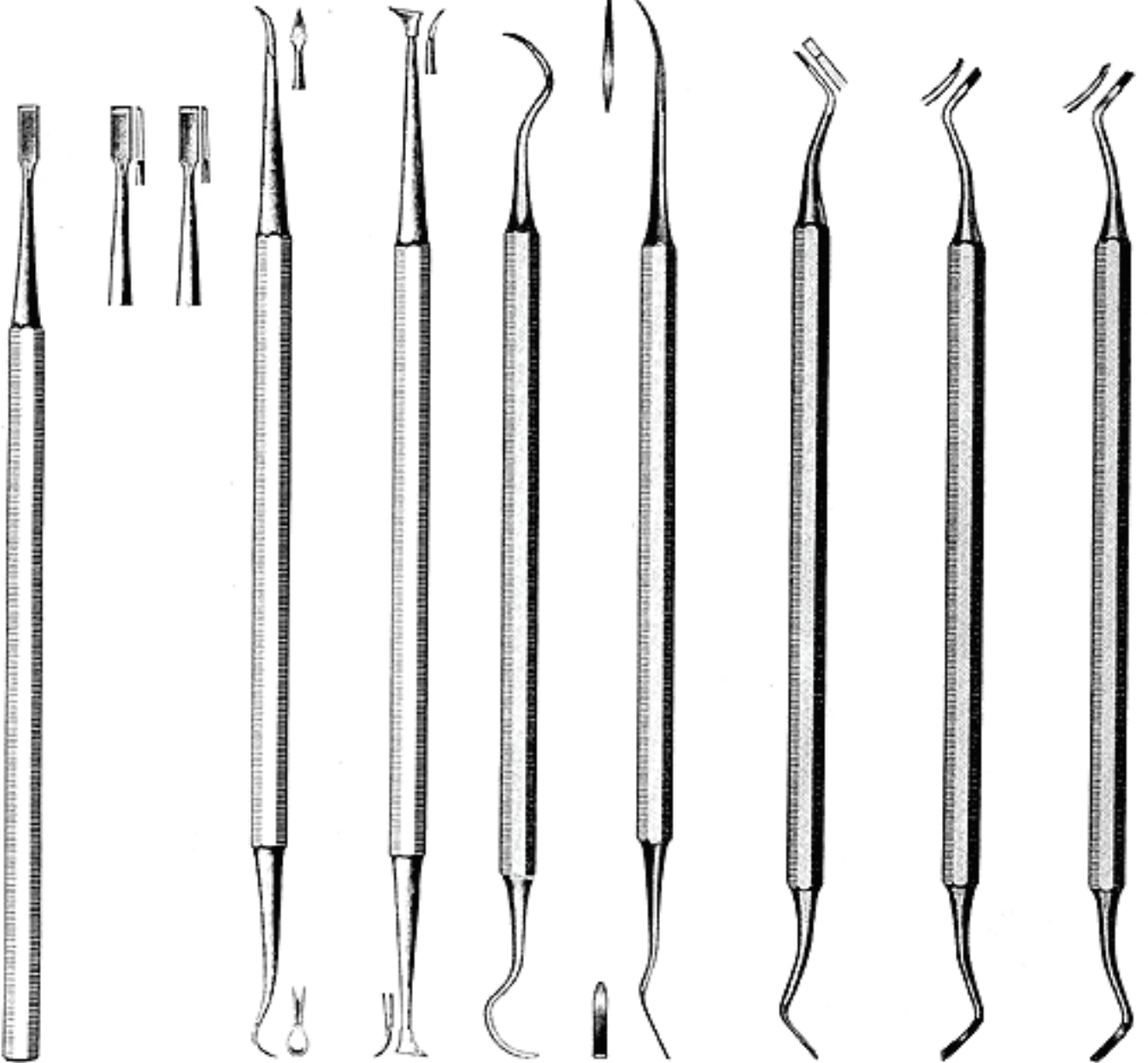

2
06-013-00

06-014-00
Cumine

06-015-00
Fher

06-016-00
White

06-017-00
Globe

06-018-00
13-14

06-019-00
77-78

06-020-00
79-80

Black

SCALERS INSTRUMENTS A DETARTRER LIMPIODORES DE SARRO

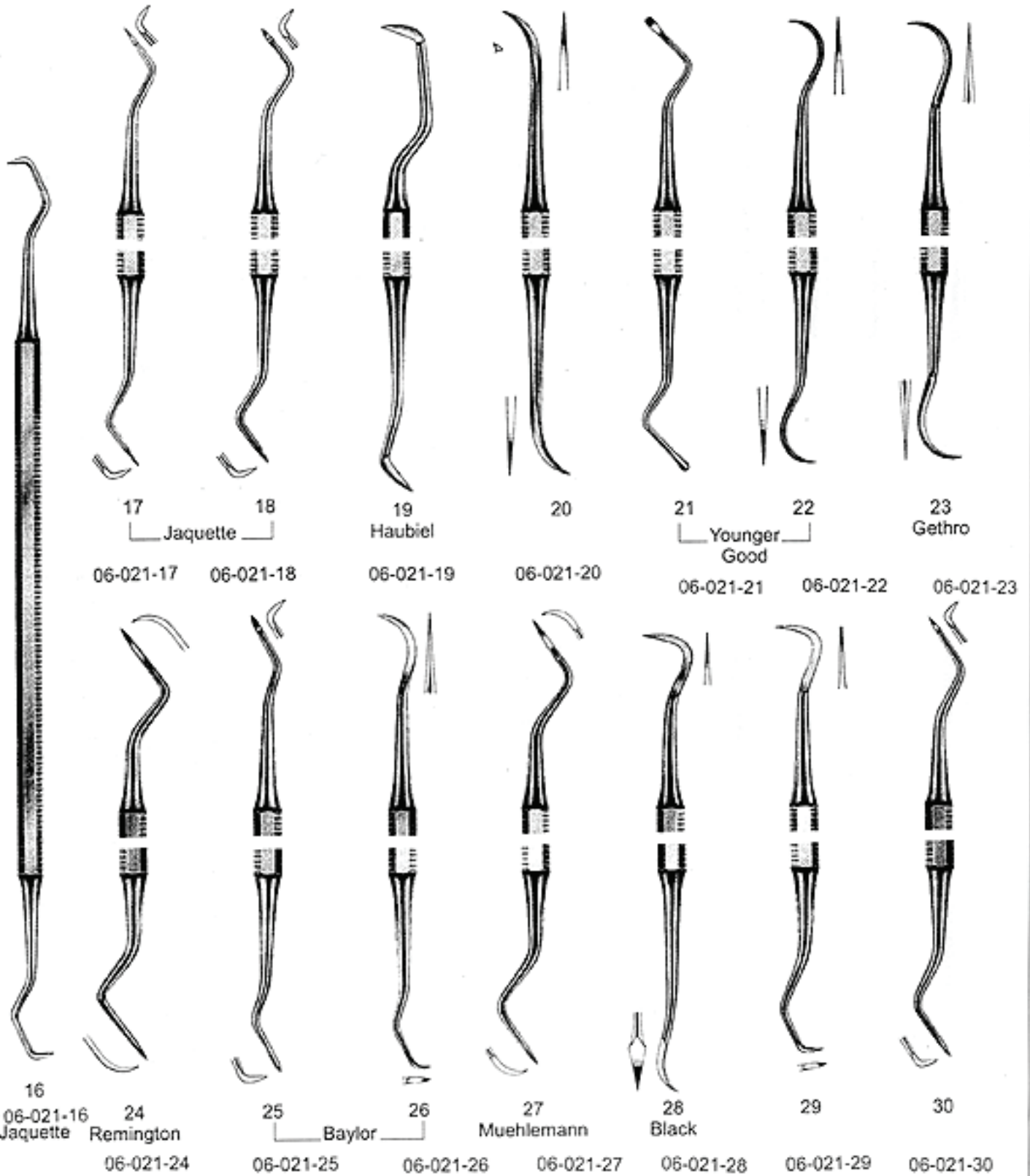

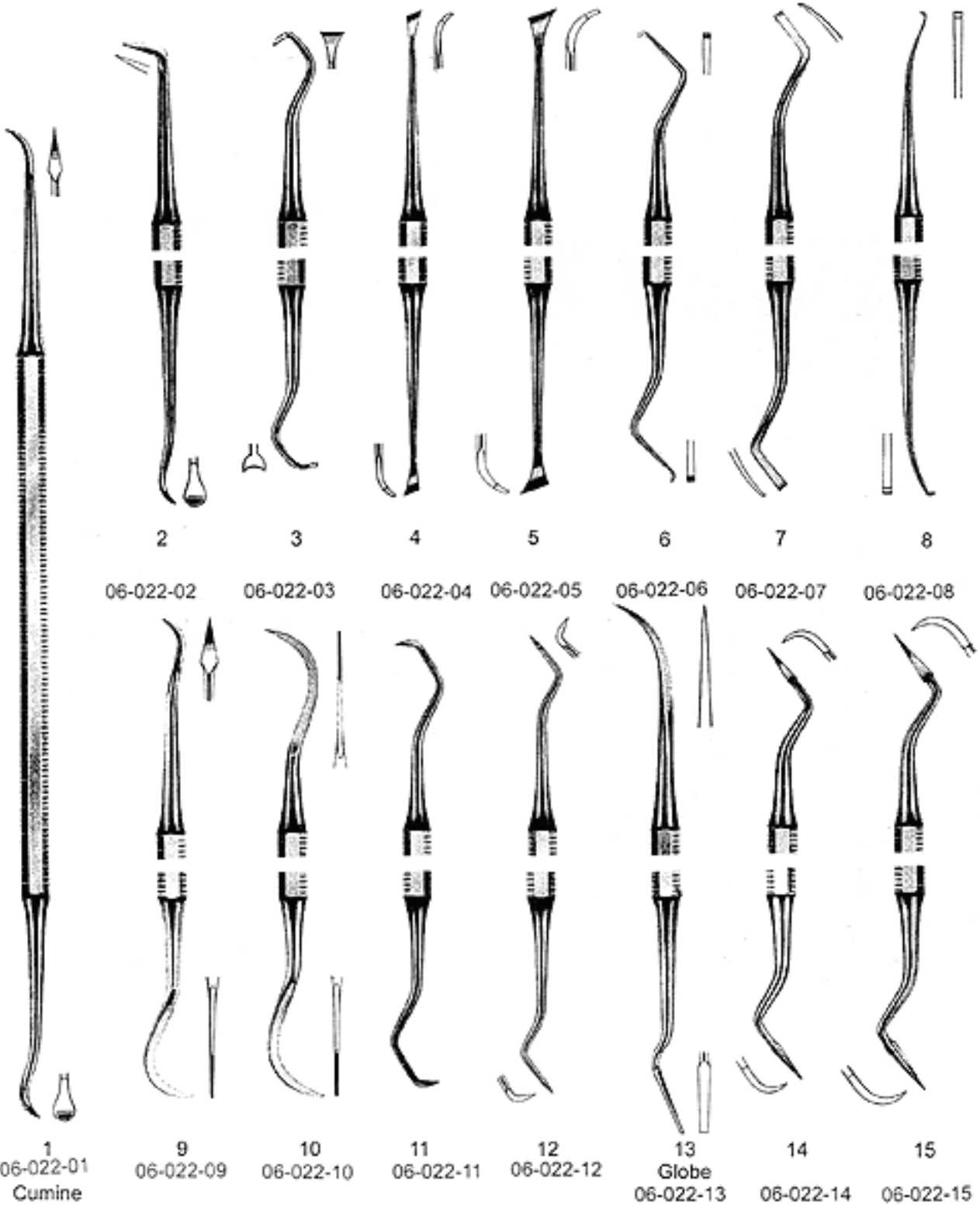

SCALERS
INSTRUMENTS A DETARTRER
LIMPIODORES DE SARRO

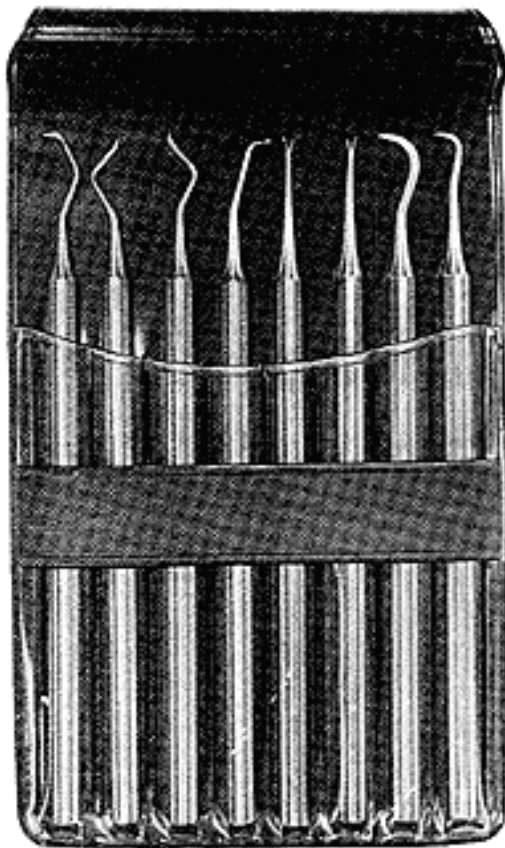

06-023-00

Set of Scalers, comprising
Figs. 06-024-01 to 06-024-08 in
black plastic wallet.

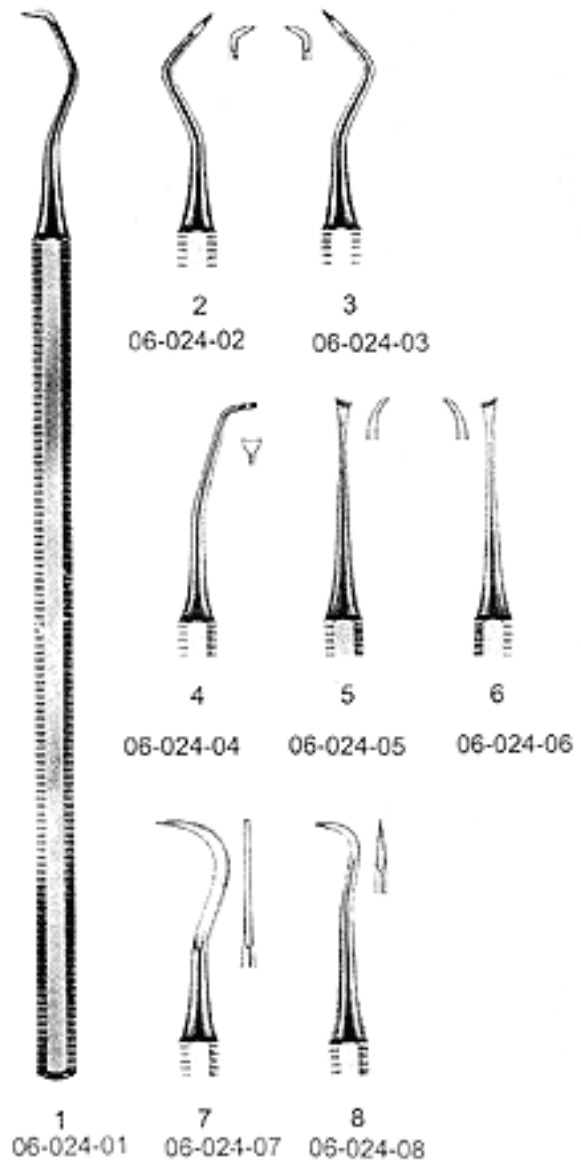

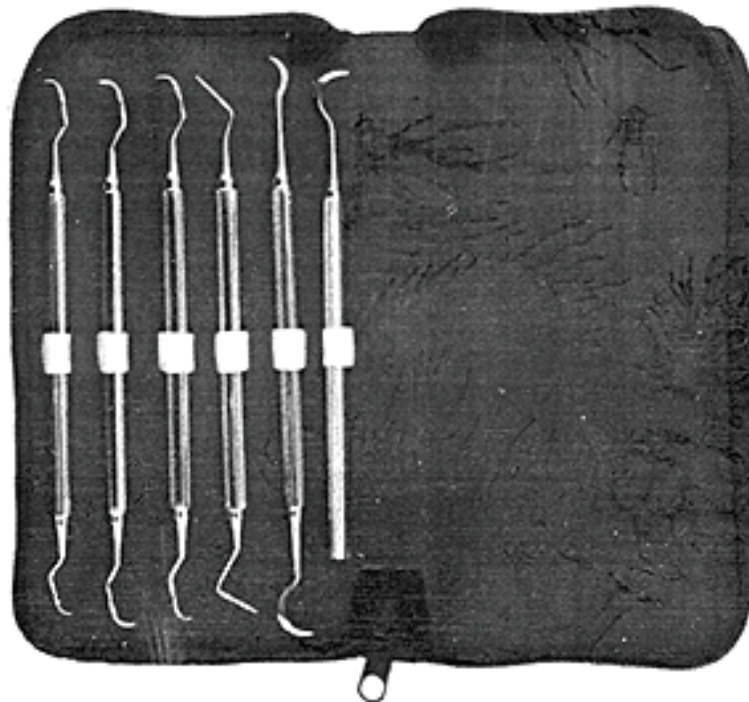

06-025-00
Scalling Set

- 1- Goldman fox pocket probe, double ended.
- 1- Jaquette scaler, single ended # 15
- 1- Jaquette scaler, double ended # U 15/33
- 1- Langer curette, double ended # L ½
- 1- Langer curette, double ended # L ¾
- 1- Langer curette, double ended # L 5/6

PERIODONTAL CURETTS
SICKLE-SCALERS
CURETAS

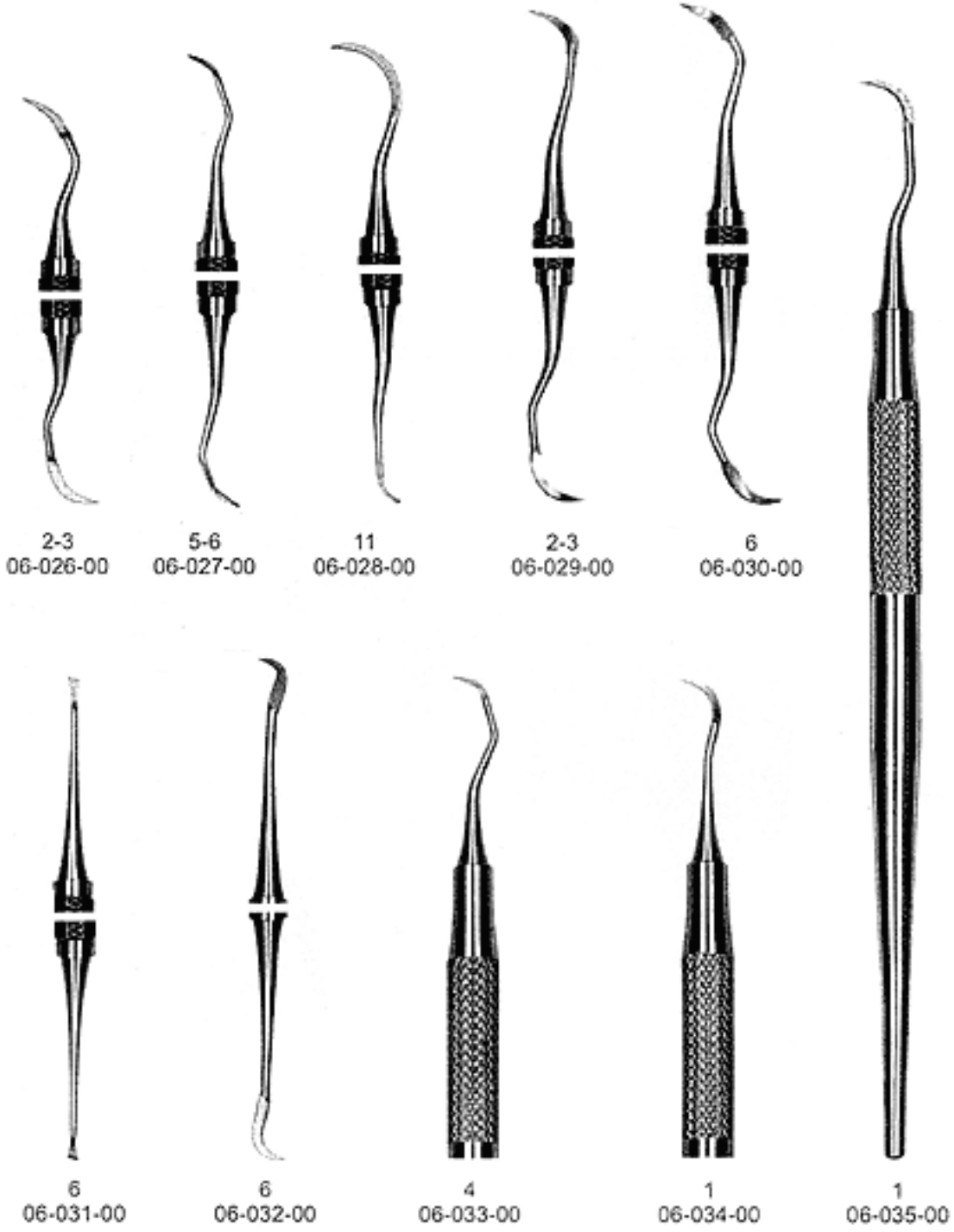

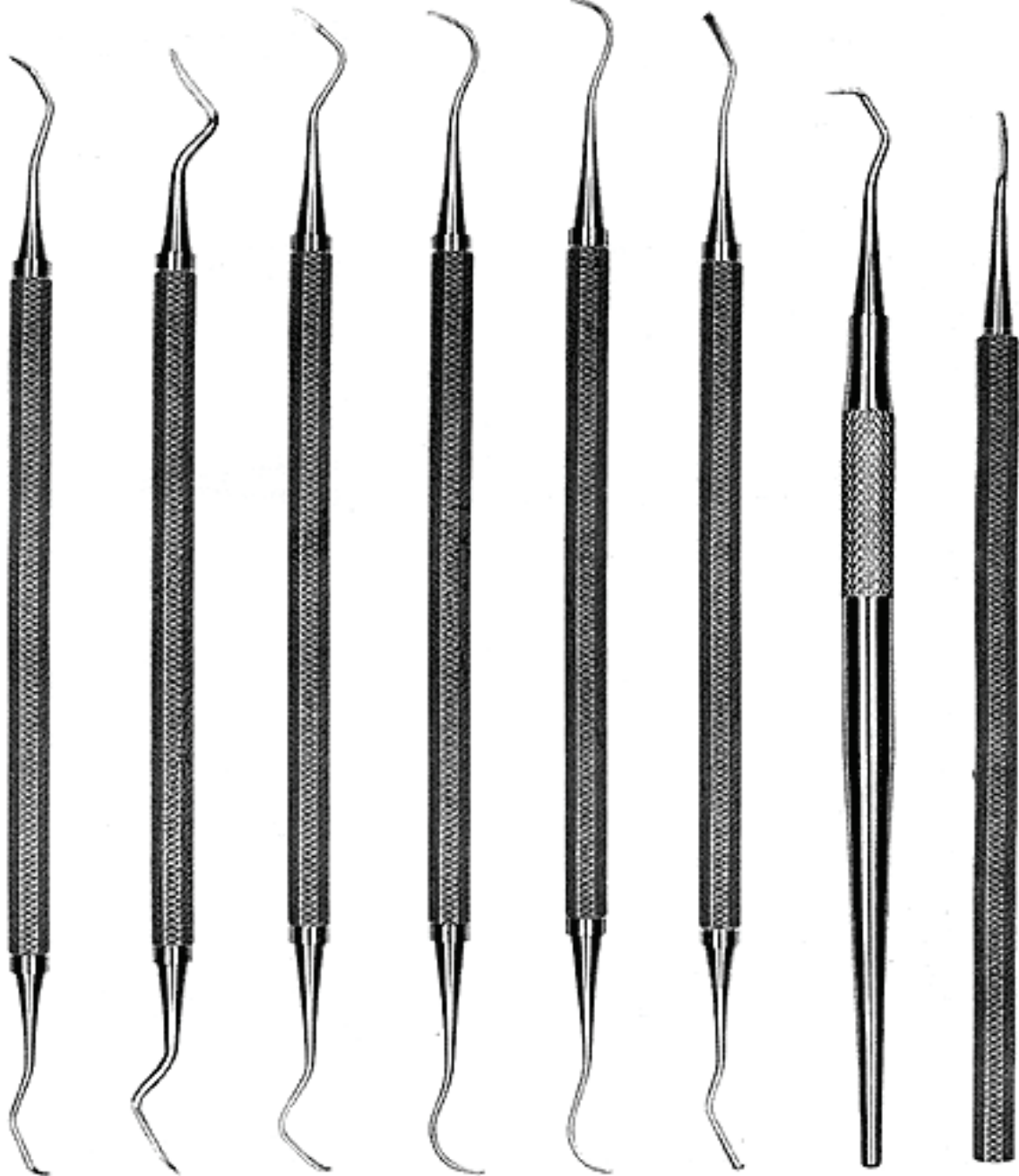

11/12
06-037-00

11A/12A
06-038-00

13S/14S
06-039-00

17S/18S
06-040-00

19/20
06-041-00

7/9
06-042-00
Hoe

10
06-043-00

1
06-044-00
Chisel

CURETTES
KURETTEN
CURETAS

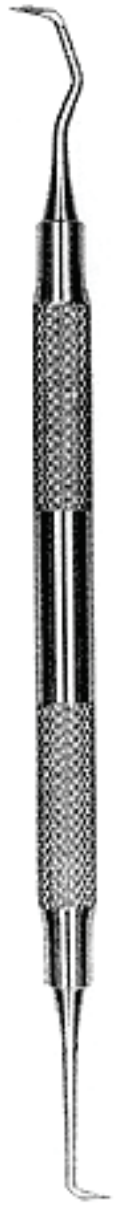

GF-1
06-045-00



GF-4
06-046-00



GF-3
06-047-00



GF-2
06-048-00



GF-6
06-049-00



GF-5
06-050-00



GF-21
06-051-00



GF-21S
06-052-00



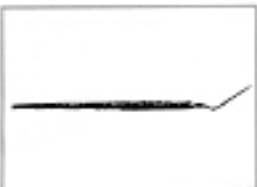

3/7
06-053-00

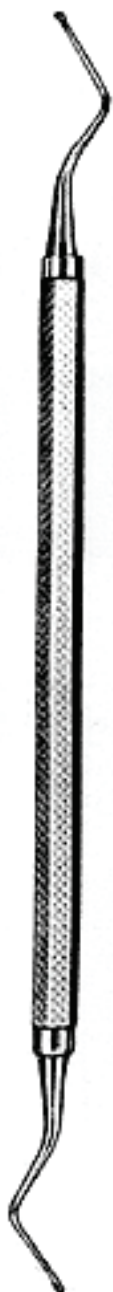

5/11
06-054-00



U15/33+
06-055-00



17S/18S+
06-056-00

CURETTES
LOFFEL
CURETAS OSEAS

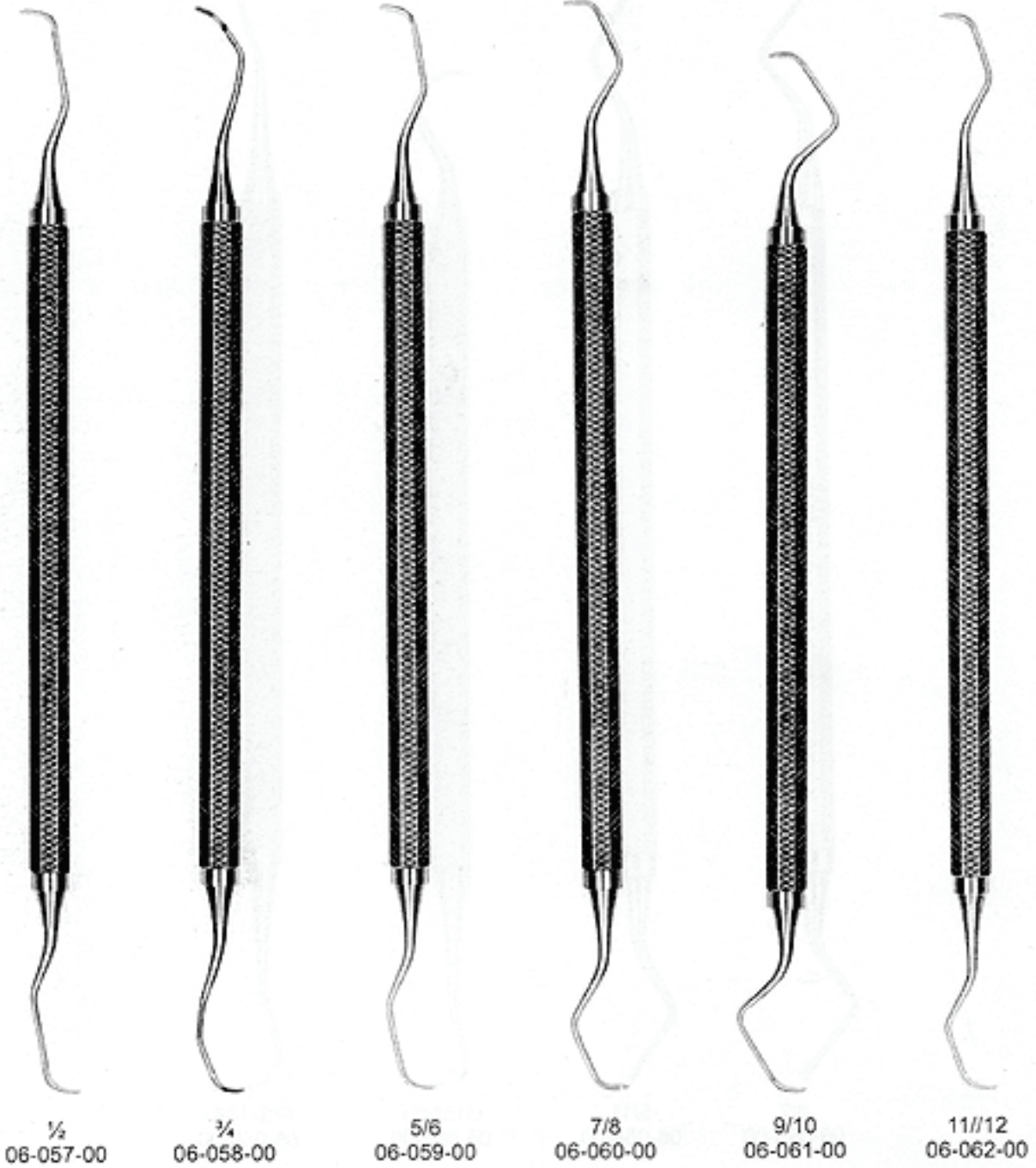



MAX GRIP

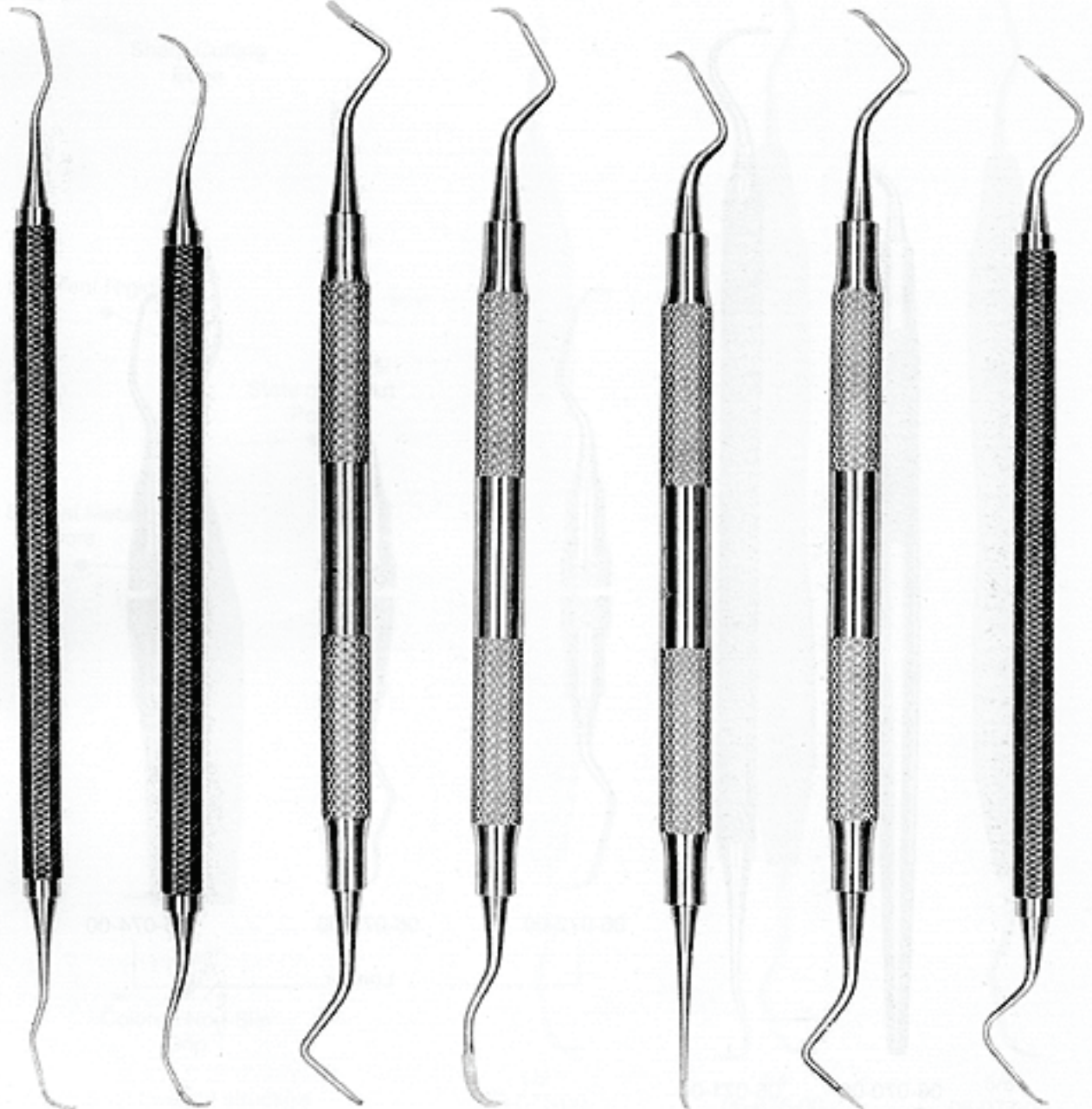

13/14
06-063-00

15/16
06-064-00

101/102
06-065-00

103/106
06-066-00

104/105
06-067-00

107/108
06-068-00

107/108S
06-069-00
Modified

CURETTES
LOFFEL
CURETAS OSEAS

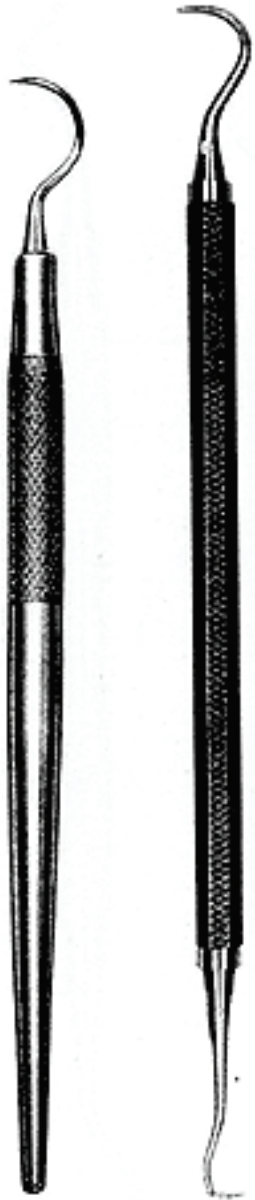

06-070-00
Towner

06-071-00
Towner
Jacquette



06-072-00



06-073-00



06-074-00

Longer



MAX GRIP

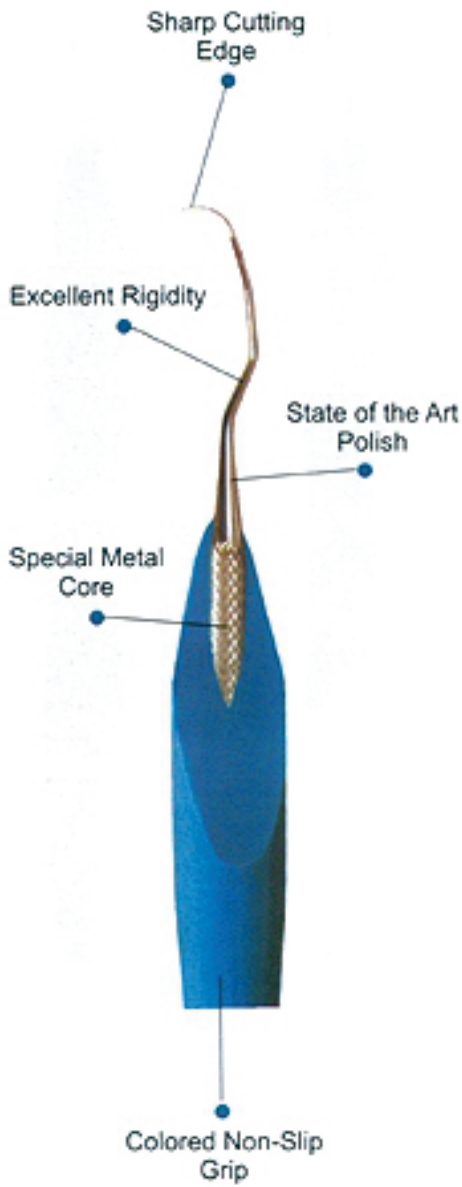

Overall light weight structure

*MAX GRIP Instruments can be sterilized / autoclaved upto 200°C
 All other type of periodontal curettes & hand instruments including explorers, filling instruments etc. are available in MAX GRIP handles.*



1/2
06-075-00



3/4
06-076-00



5/6
06-077-00



MAX GRIP



7/8
06-078-00



9/10
06-079-00



11/12
06-080-00



13/14
06-081-00



15/16
06-082-00



Gracey
1/2
06-108-00



Gracey
3/4
06-109-00



Gracey
5/6
06-110-00



Gracey
7/8
06-111-00



Gracey
9/10
06-112-00



Gracey
11/12
06-113-00



Gracey
13/14
06-114-00

NOTE: All other hand instruments are also available in this Hollow Handle

CURETTES
LOFFEL
CURETAS OCEAS

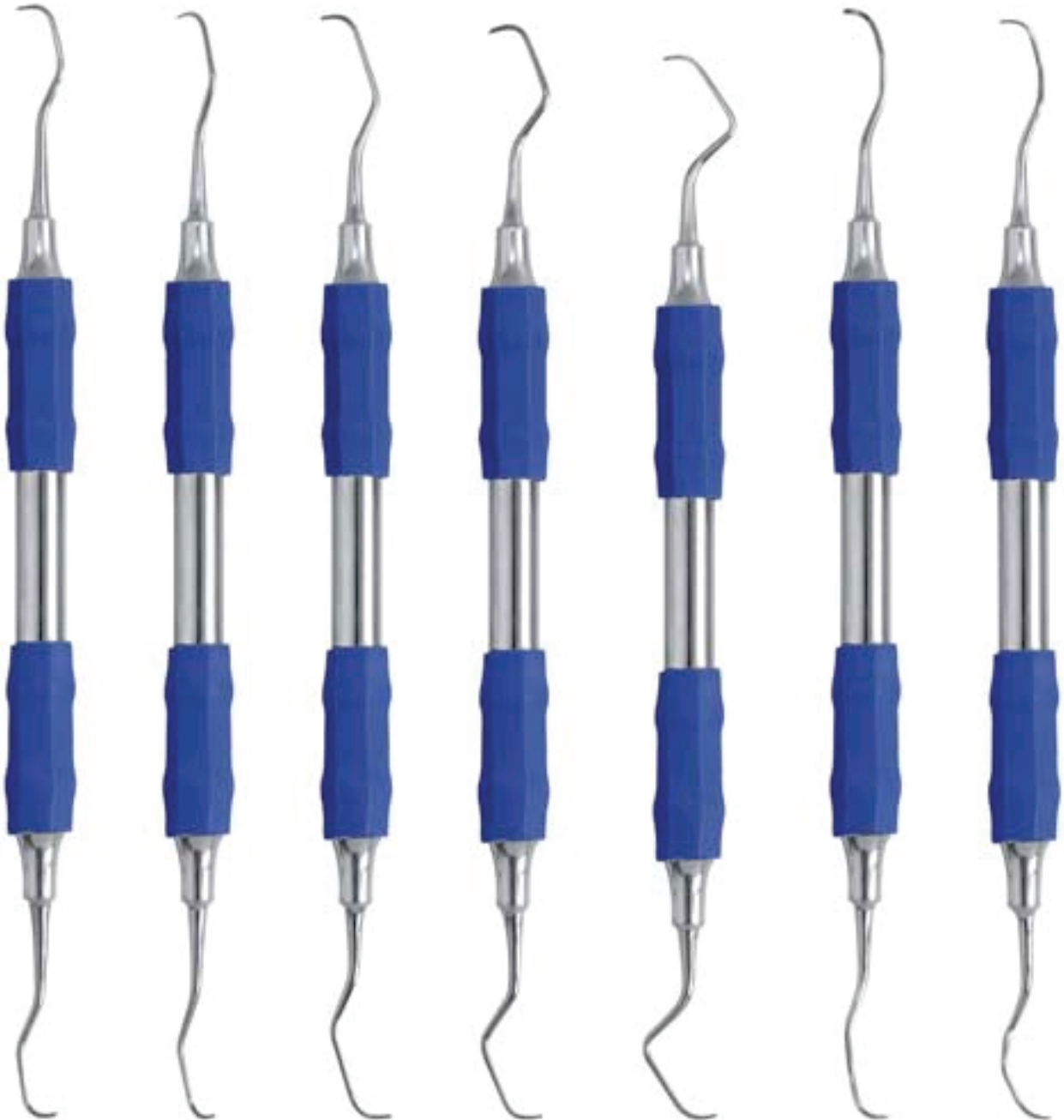

Gracey
1/2
06-120-00

Gracey
3/4
06-121-00

Gracey
5/6
06-122-00

Gracey
7/8
06-123-00

Gracey
9/10
06-124-00

Gracey
11/12
06-125-00

Gracey
13/14
06-126-00

NOTE: All other hand instruments are also available in SOFTHOLD Handle

Department

07

EXCAVATORS
EXCAVATOREN
EXCAVADORES

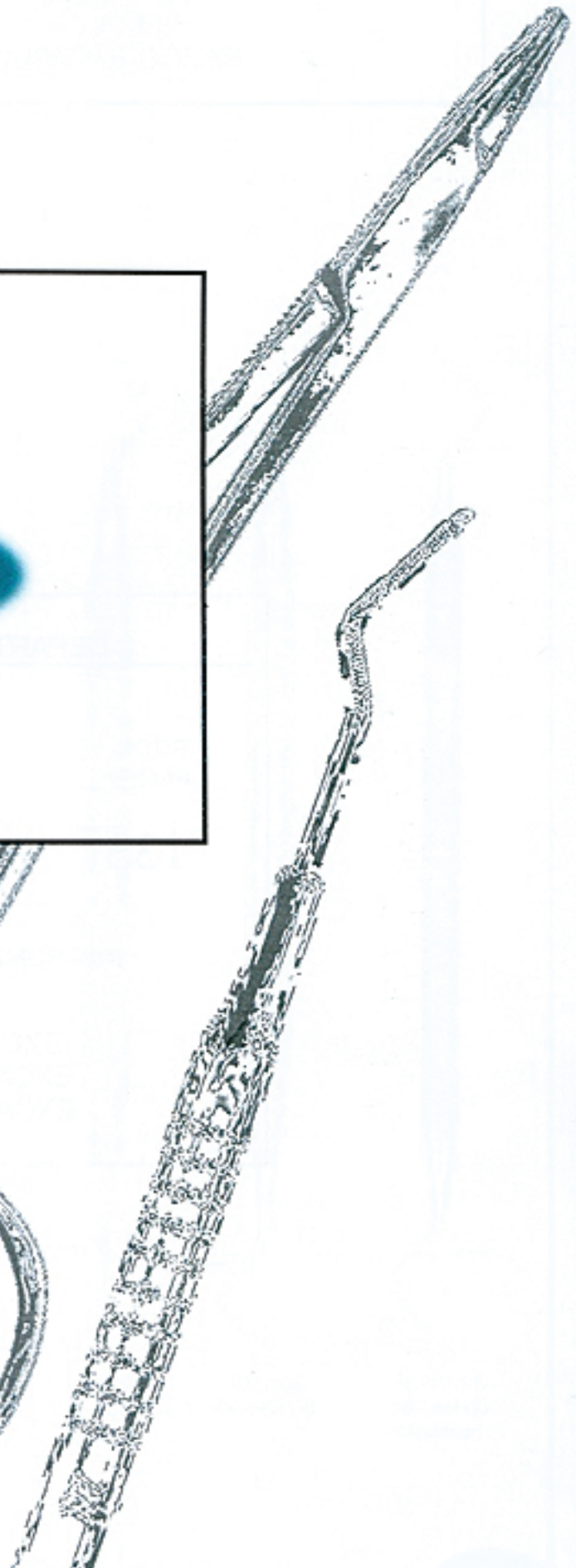
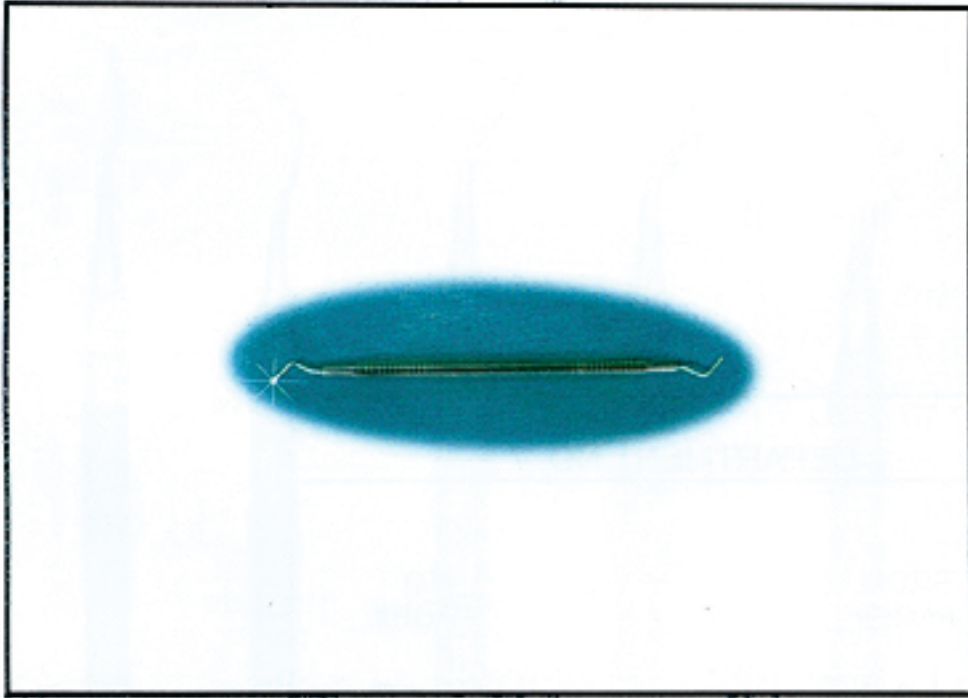

DEPARTMENT NO. 7

FROM
PAGE#

133

TO
PAGE#

143

INSTRUMENTS CATEGORY

EXCAVATORS
EXCAVATOREN
EXCAVADORES

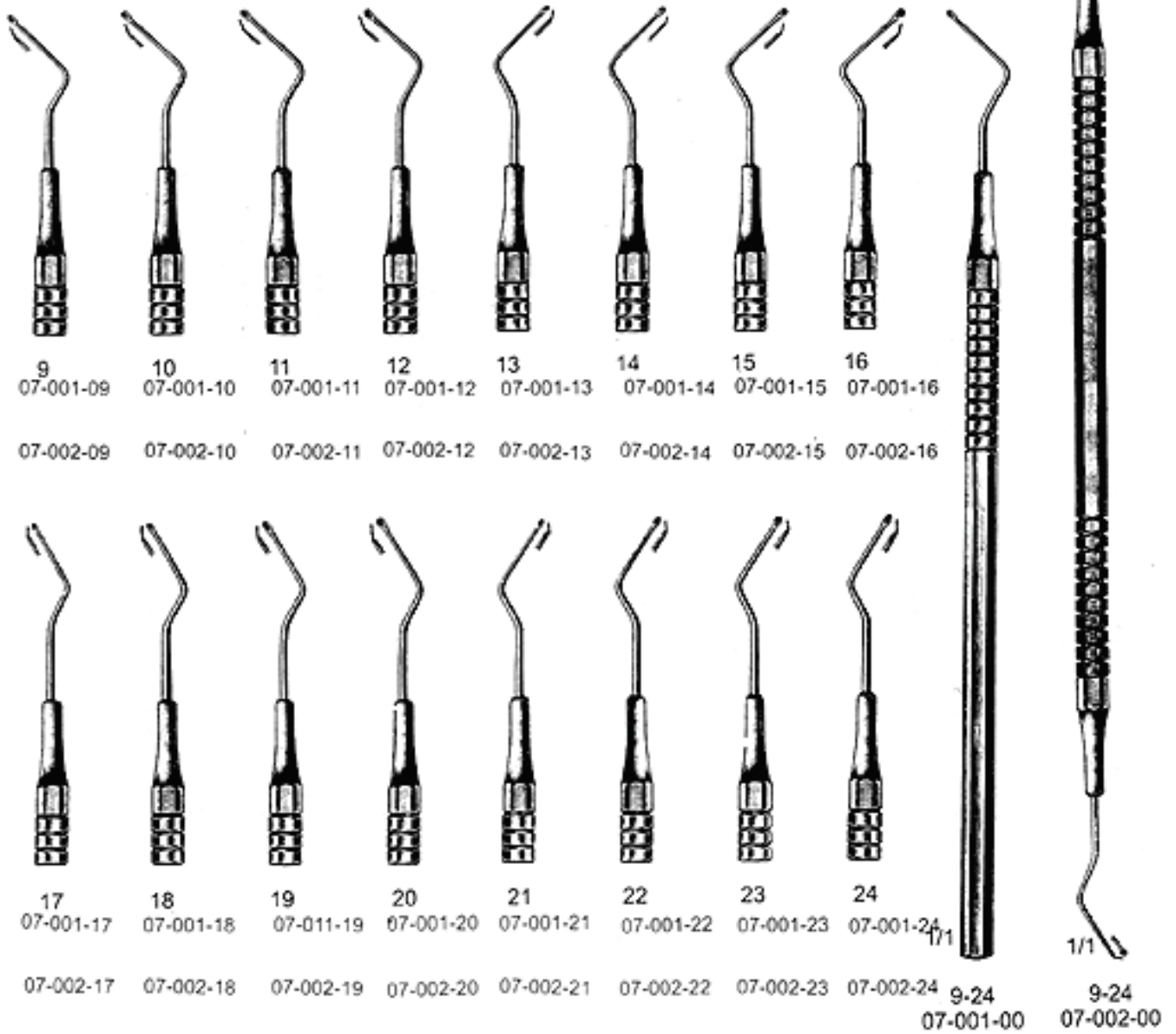



51-52
07-003-00



57-58
07-004-00



63-64
07-005-00



75-76
07-006-00



81-82
07-007-00



17-21
07-008-00



18-22
07-009-00



18-23
07-010-00

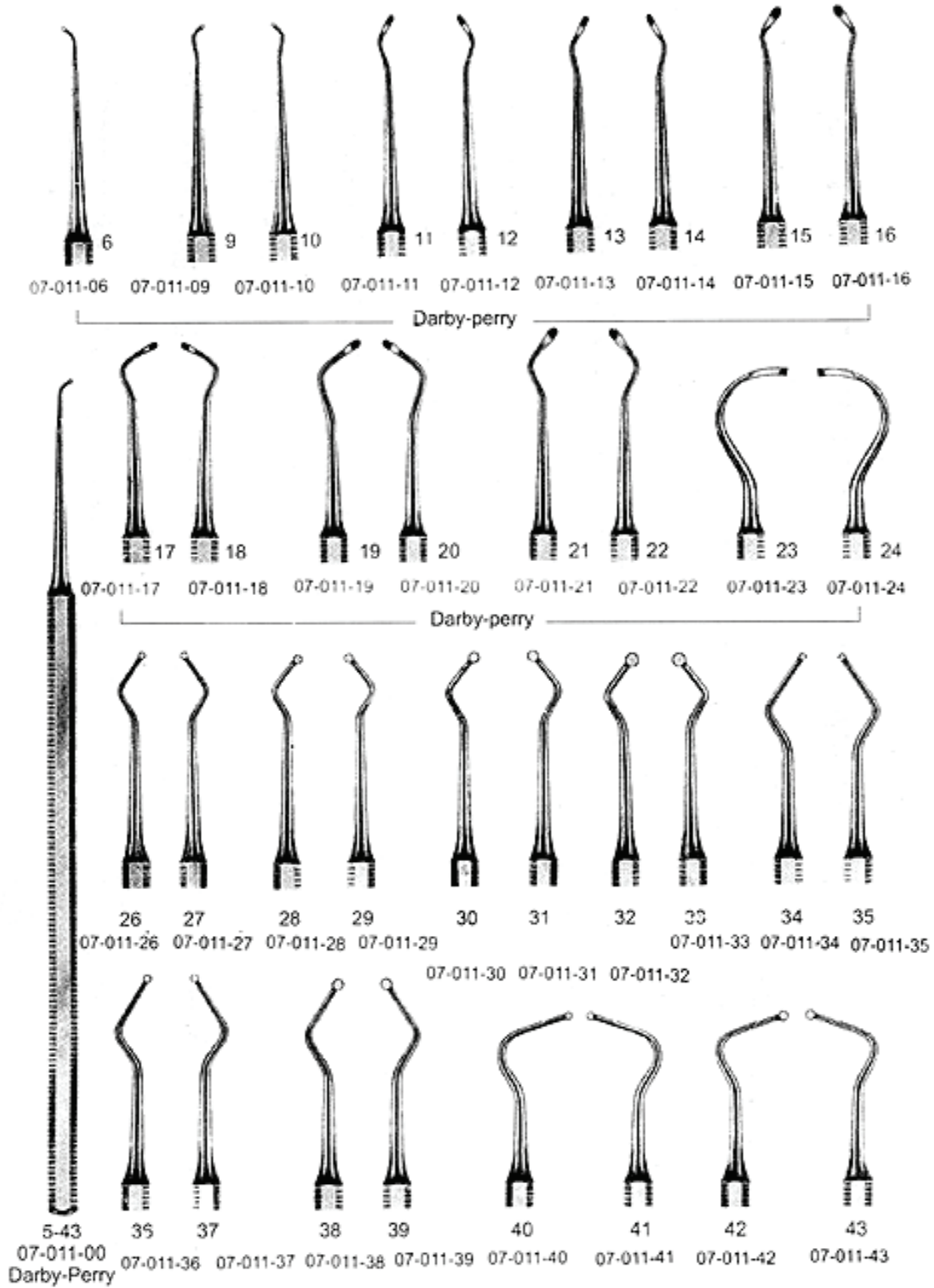

EXCAVATORS
EXCAVATOREN
EXCAVADORES

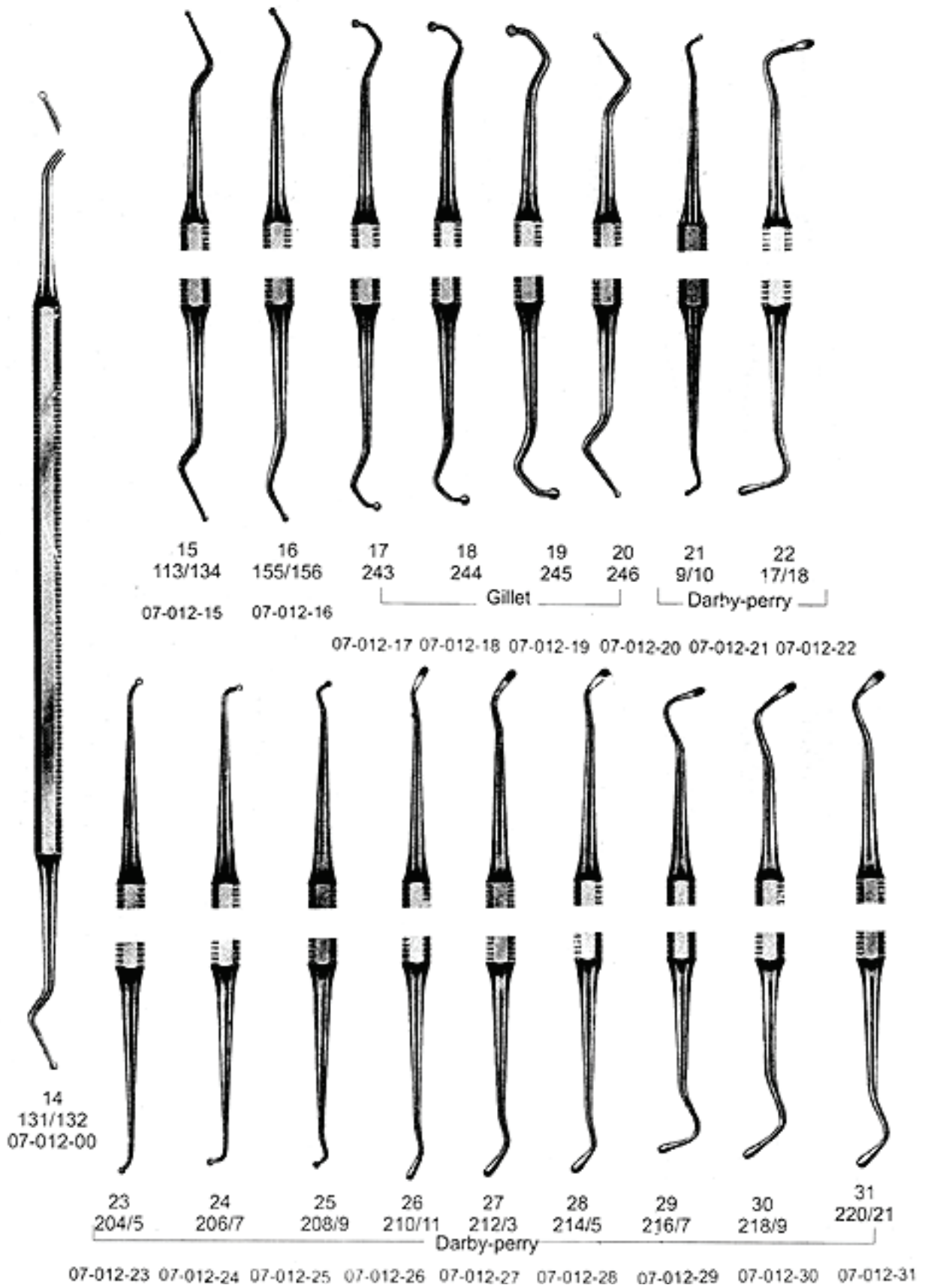

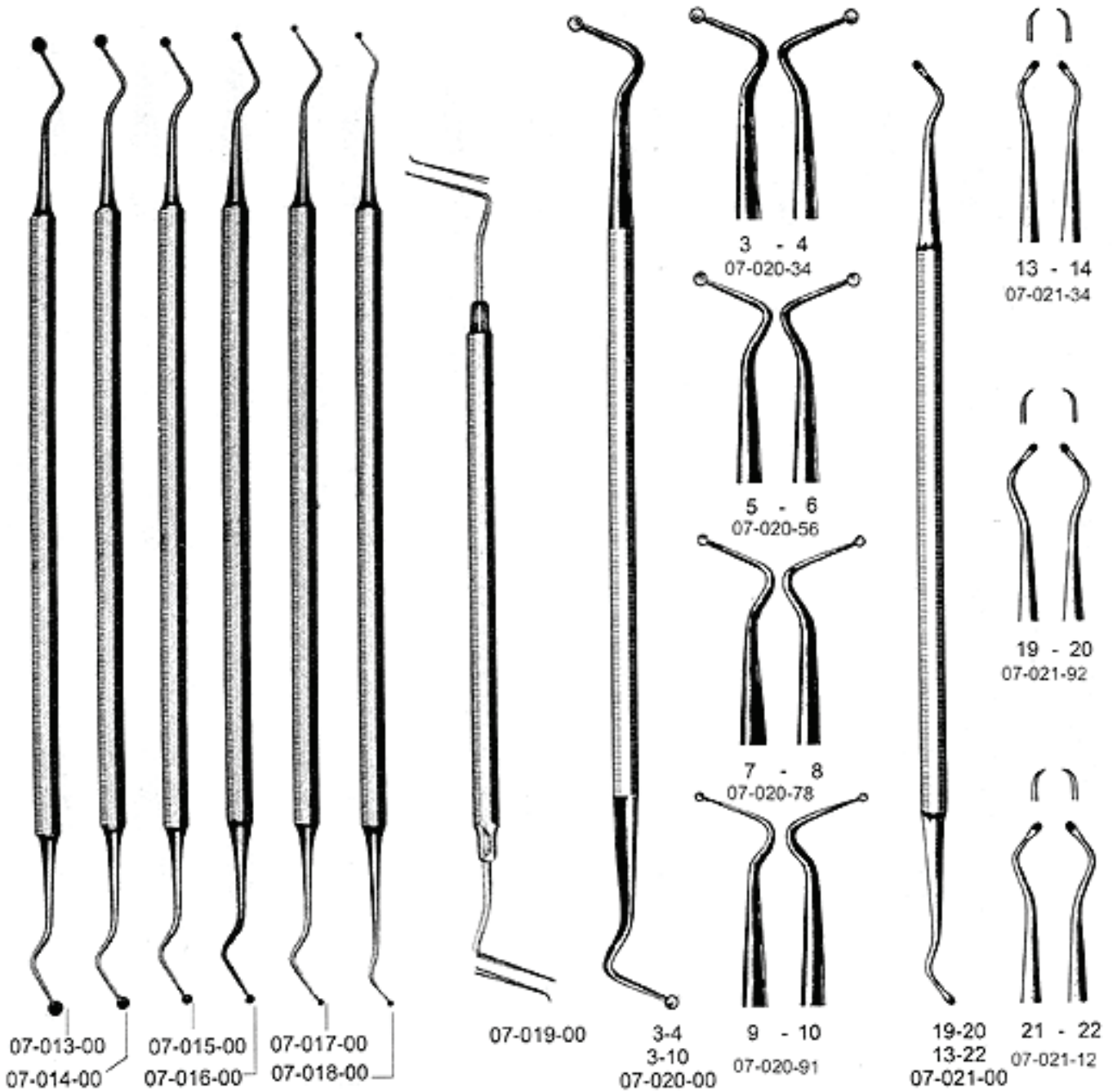

EXCAVATORS
EXCAVATOREN
EXCAVADORES

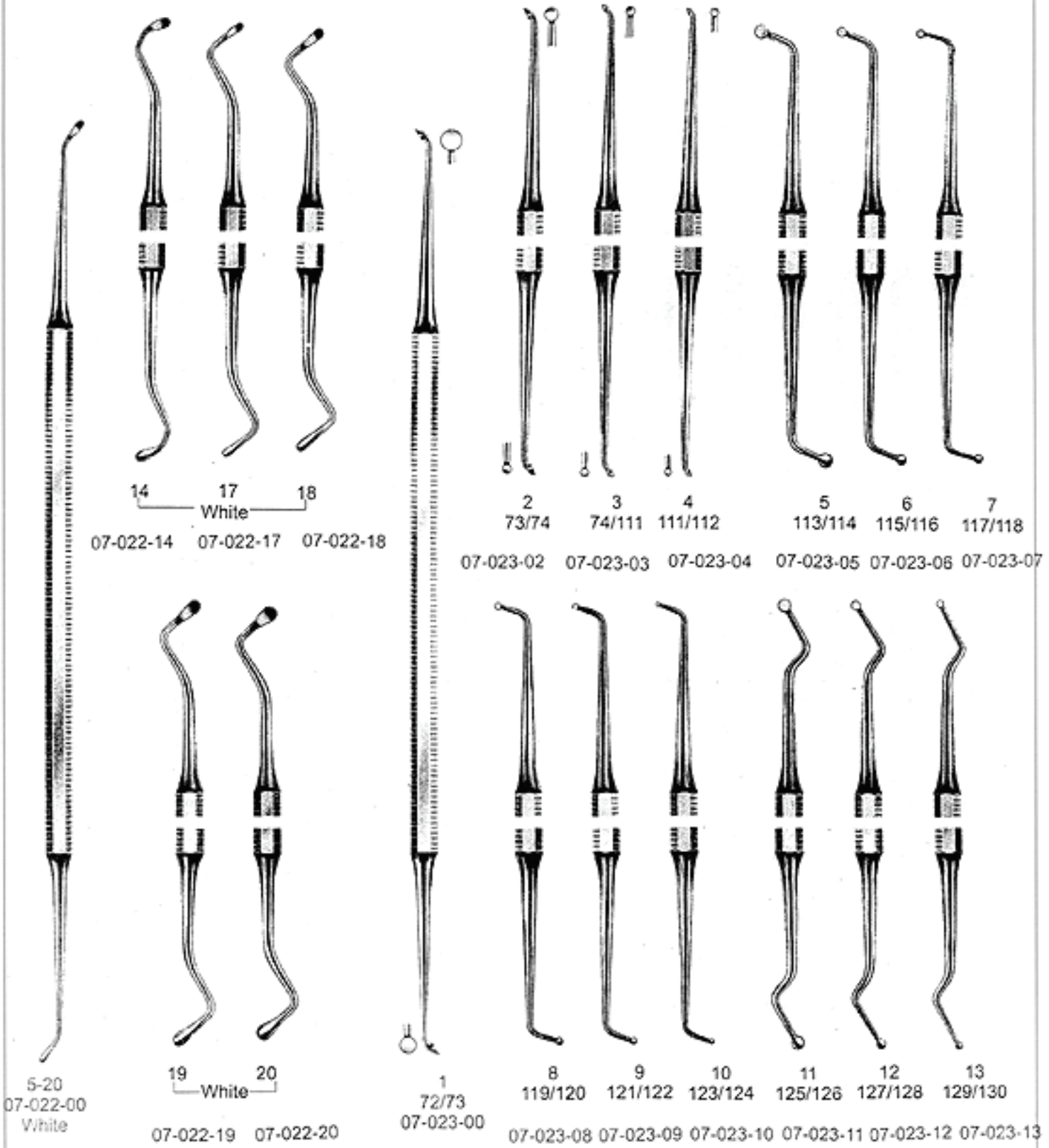

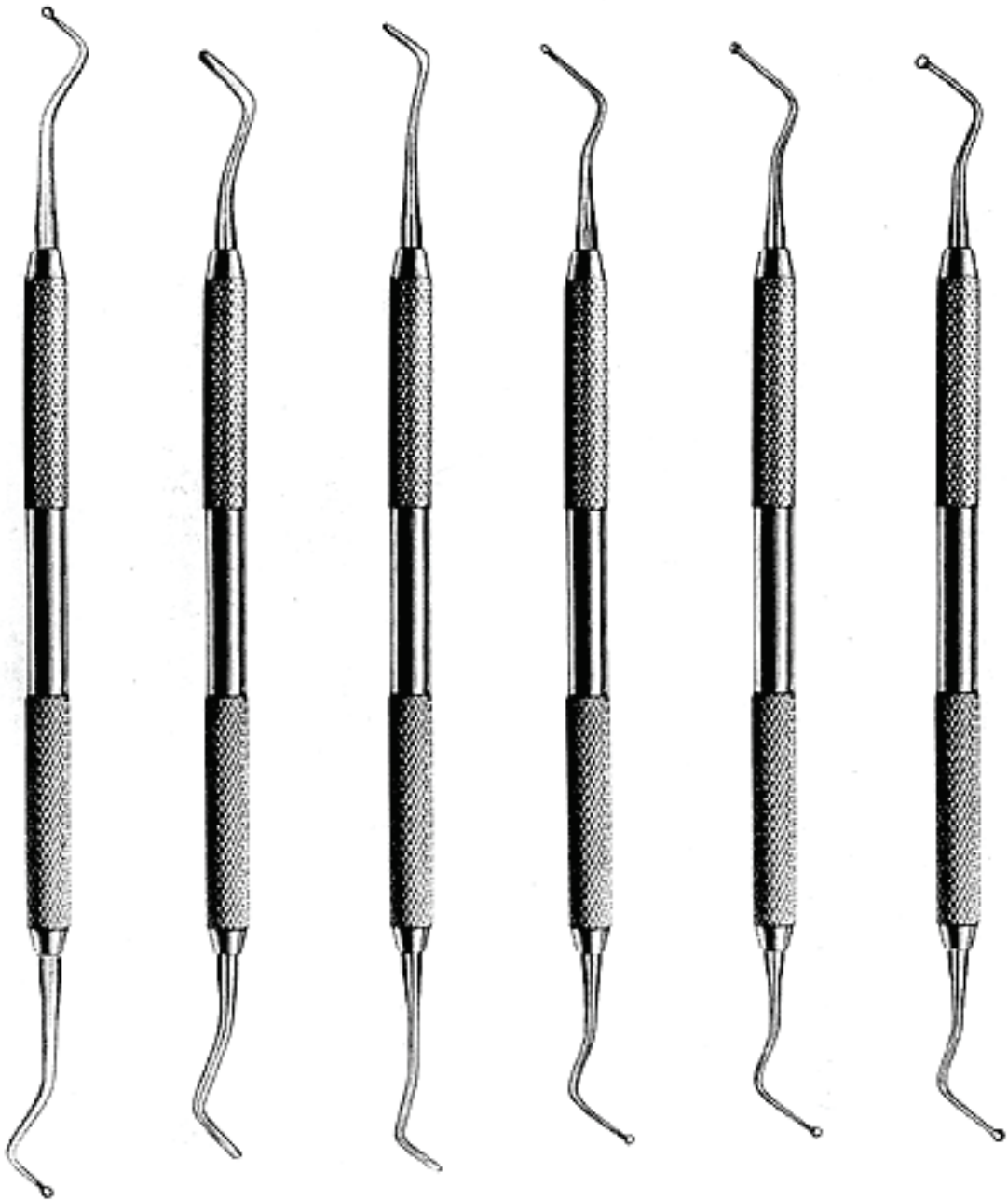

39
Fig.38/39
07-024-00

64
Fig.63/64
07-025-00

66
Fig.65/66
07-026-00

31L
07-027-00

32L
07-028-00

33L
07-029-00

EXCAVATORS
EXCAVATOREN
EXCAVADORES

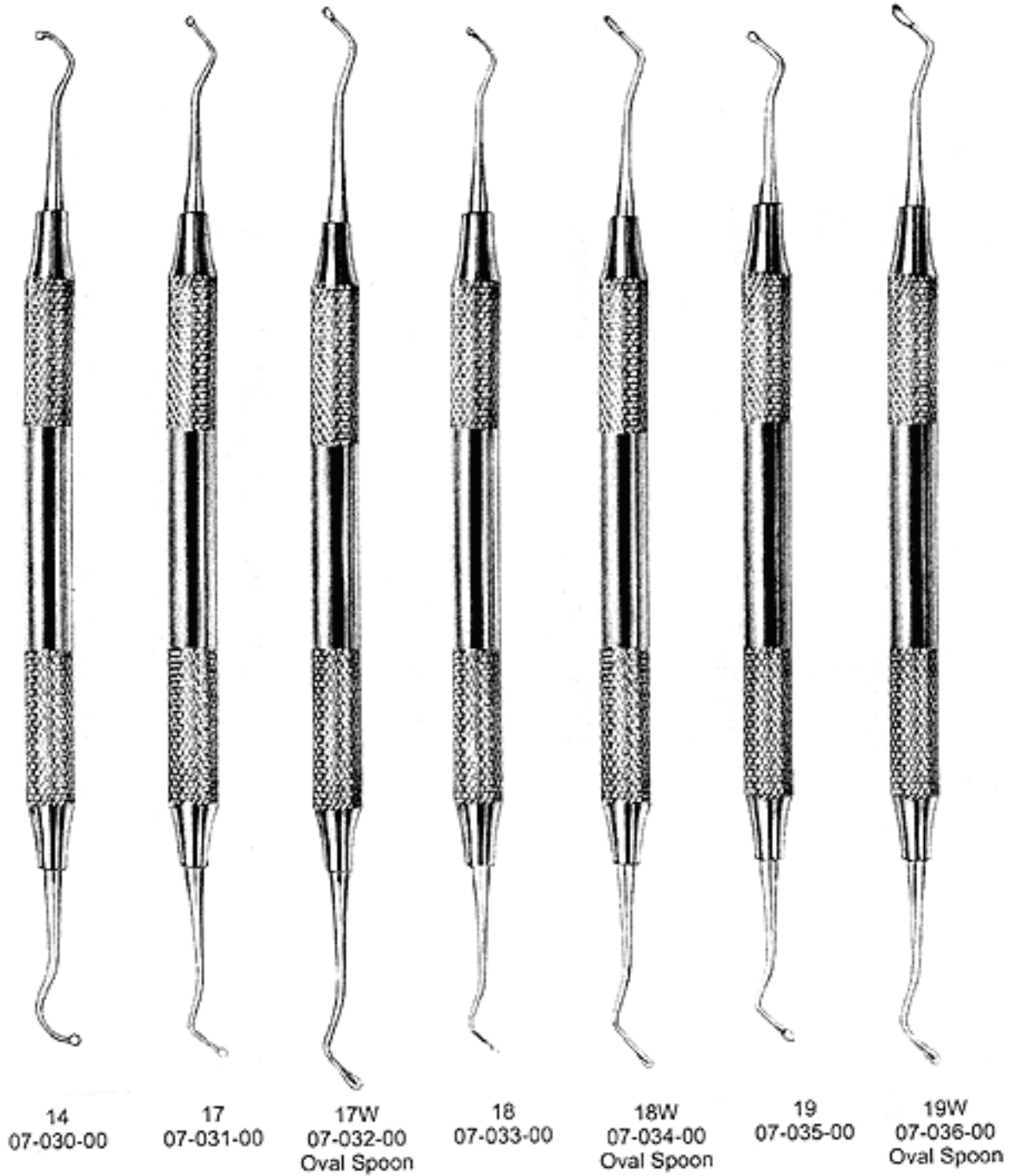



Department

08

PROBES AND EXPLORERS
SONDES ET EXPLORATEURS
SONDAS Y EXPLORADORES

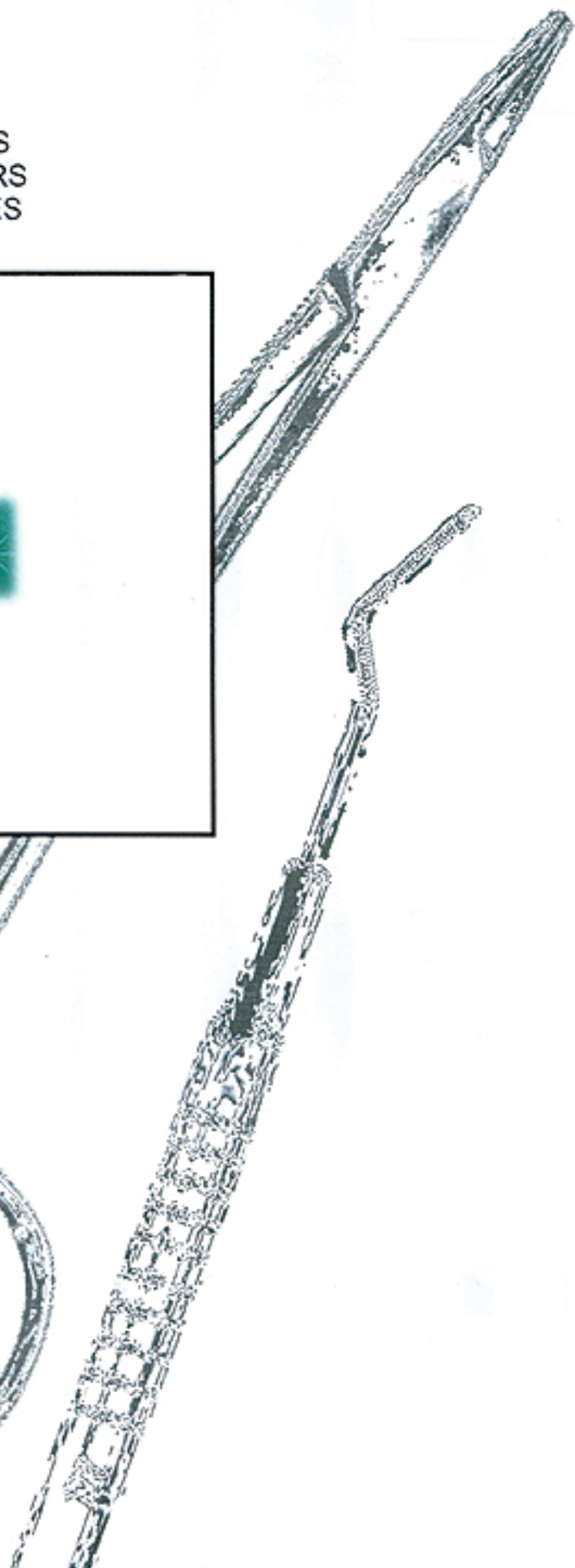
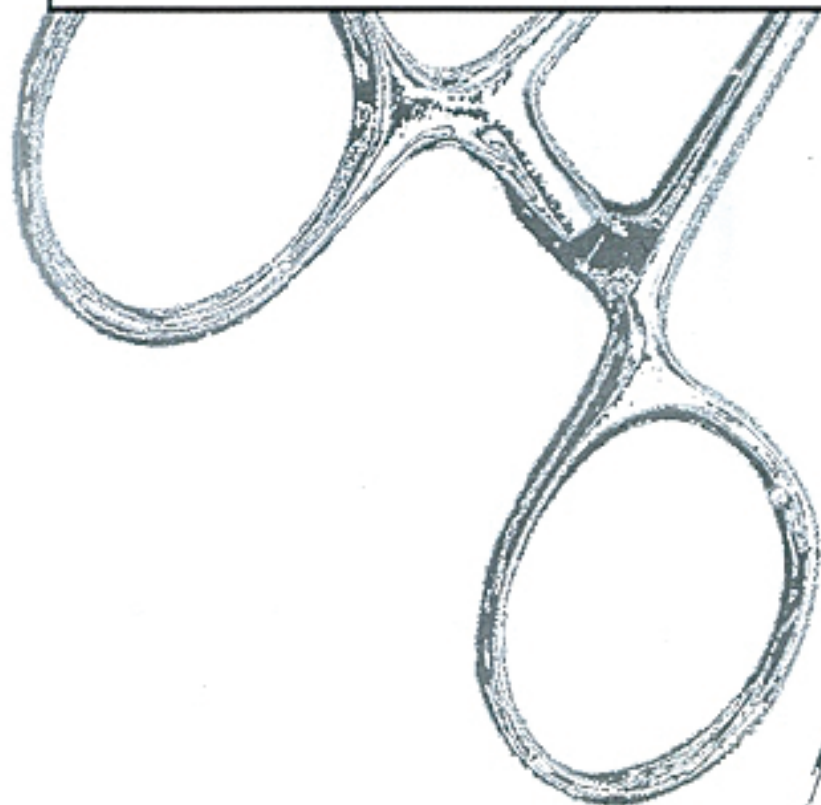
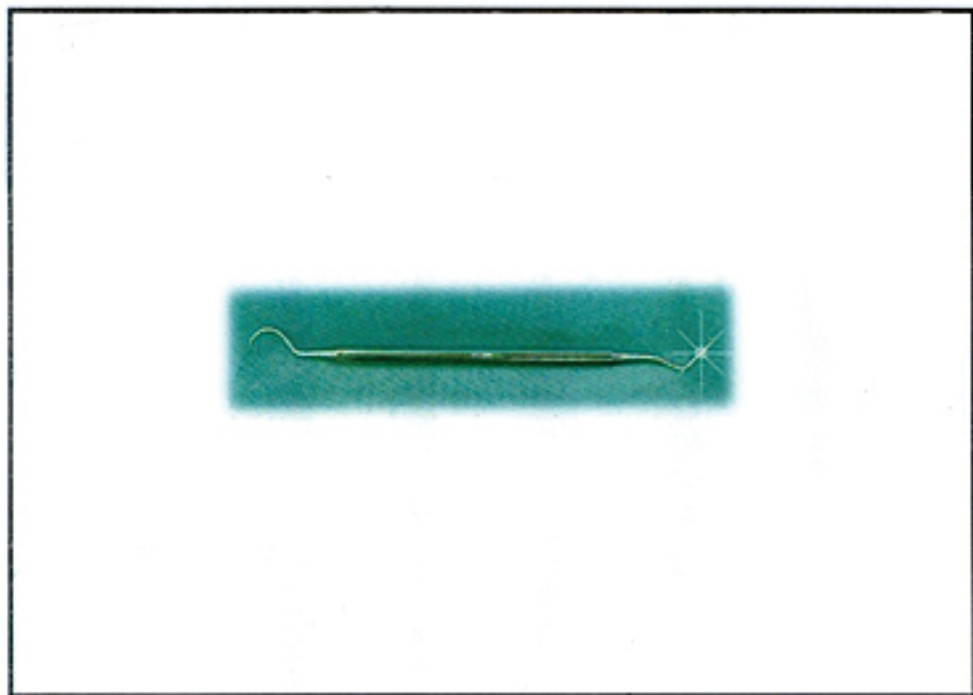

DEPARTMENT NO. 8

FROM
PAGE#

144

TO
PAGE#

150

INSTRUMENTS CATEGORY

PROBES AND EXPLORERS
SONDES ET EXPLORATEURS
SONDAS Y EXPLORADORES

PROBES AND EXPLORERS SONDES ET EXPLORATEURS SONDAS Y EXPLORADORES

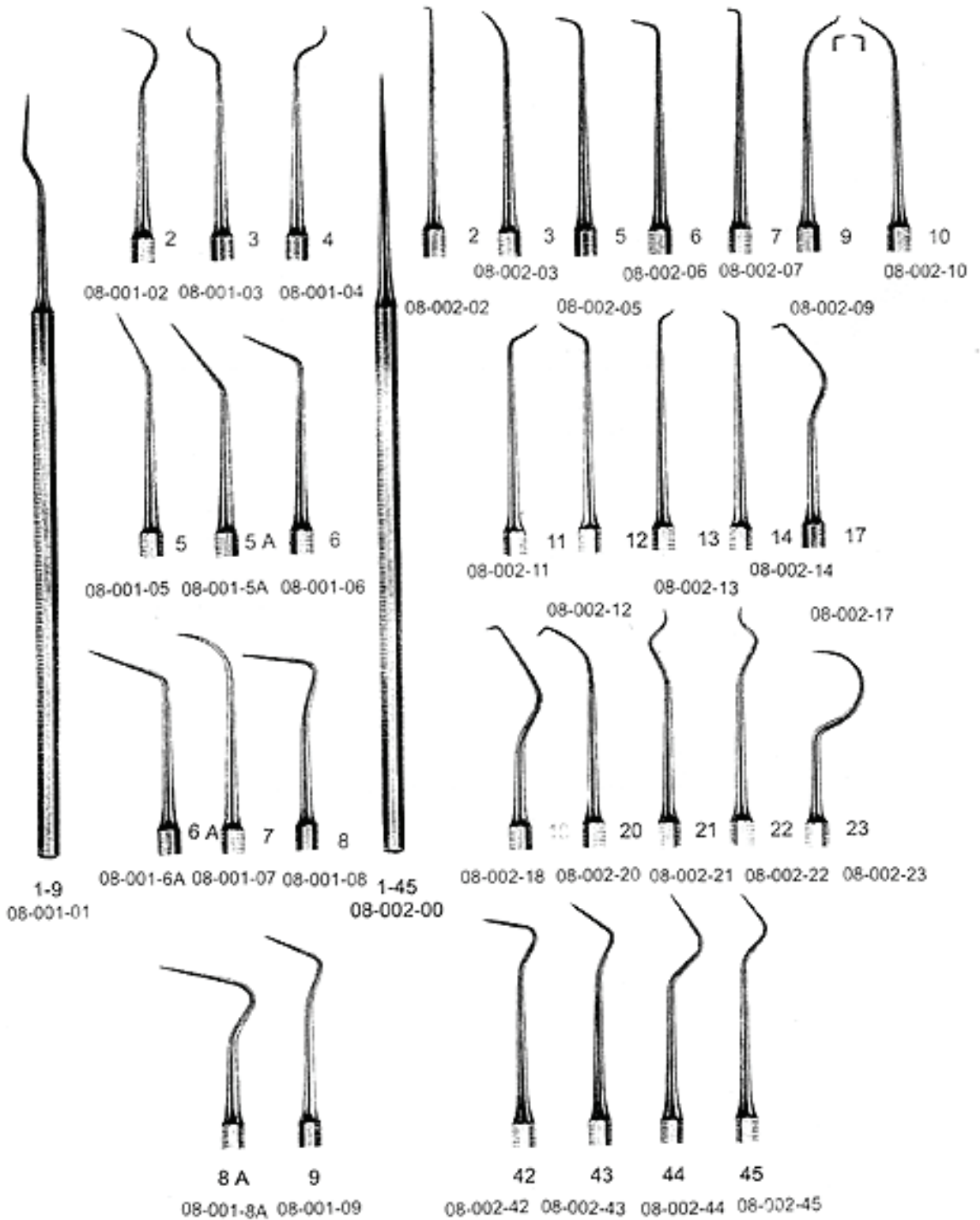

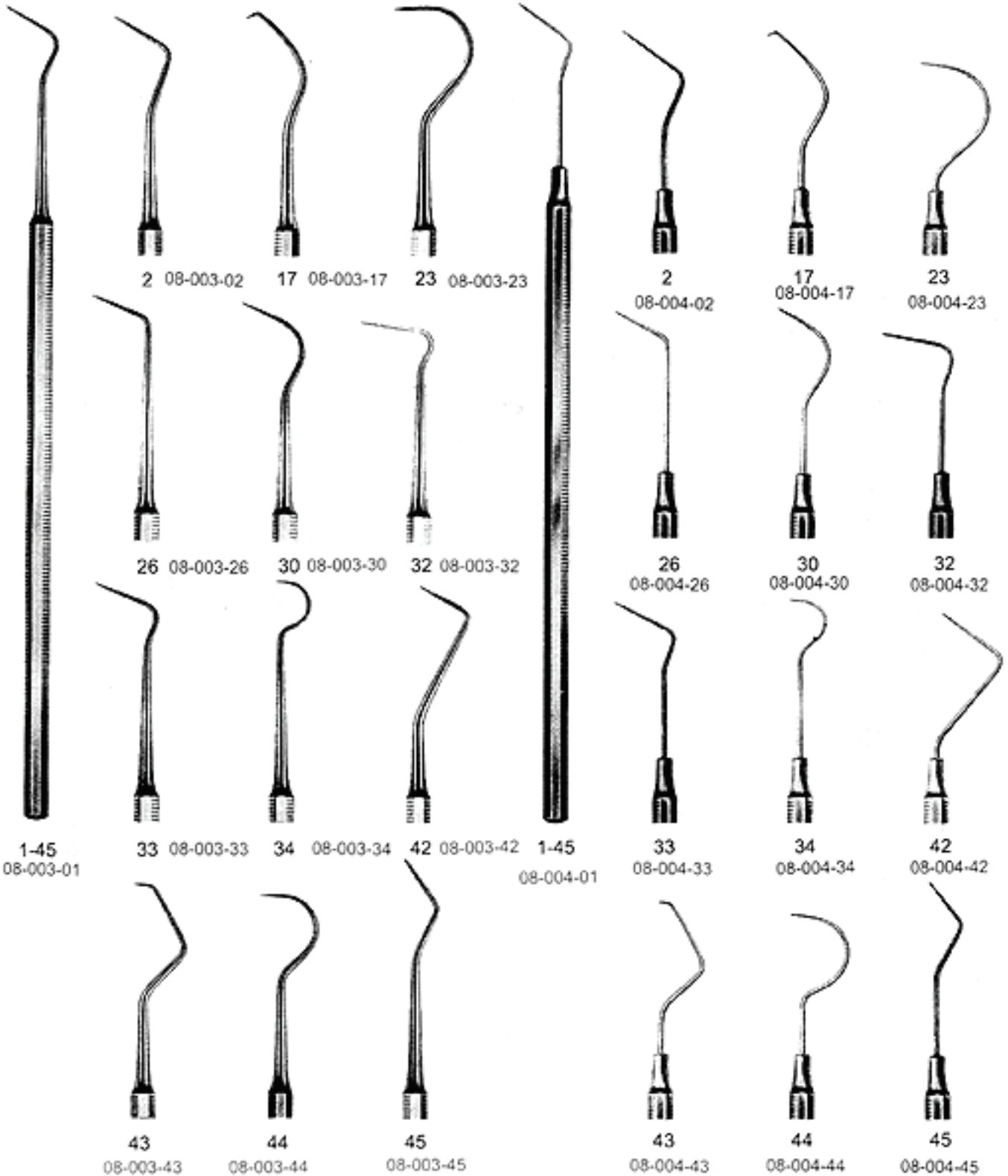

EXPLORERS ZAHNSONDEN SONDAS

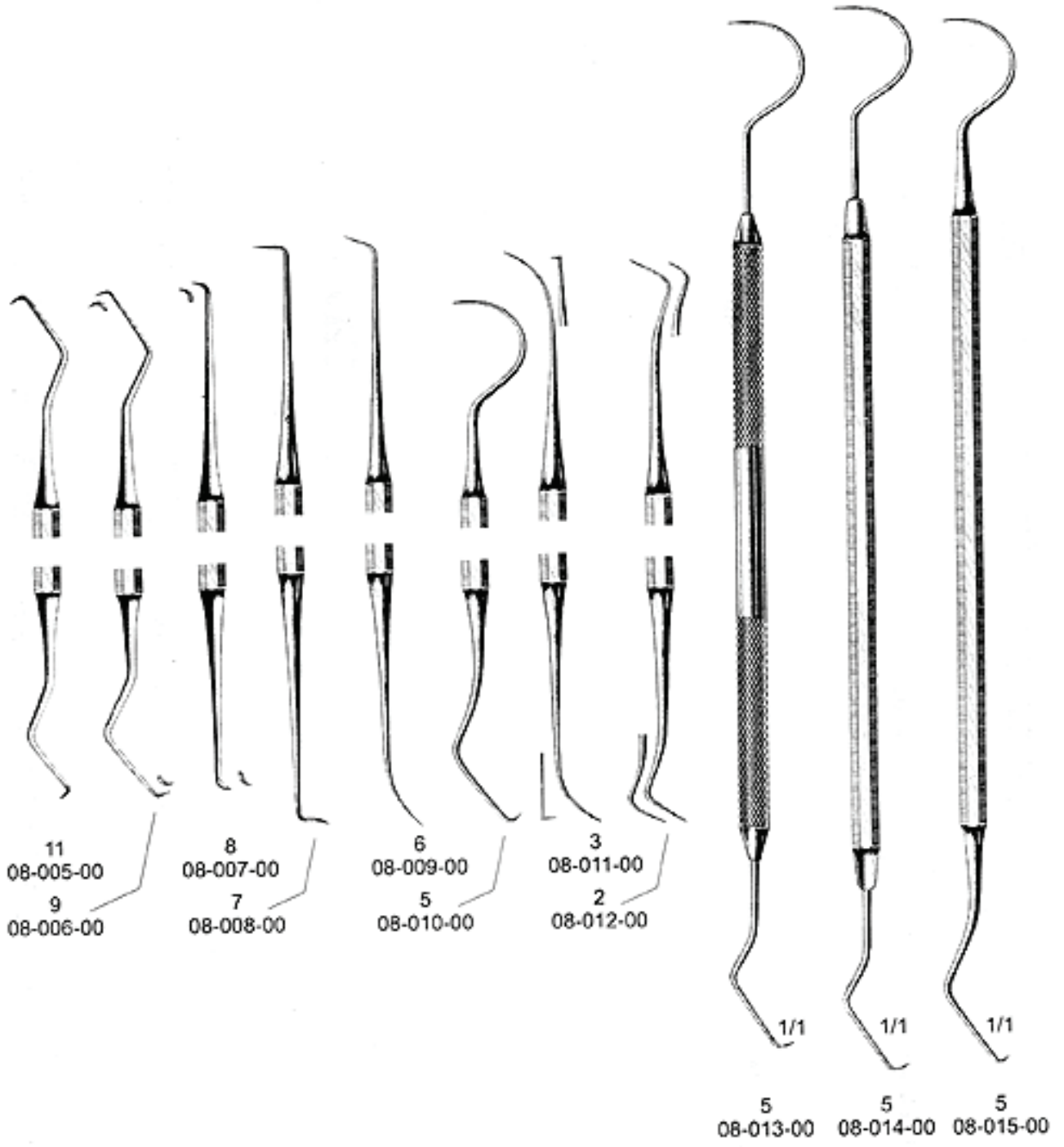

EXPLORERS
ZAHNSONDEN
SONDAS

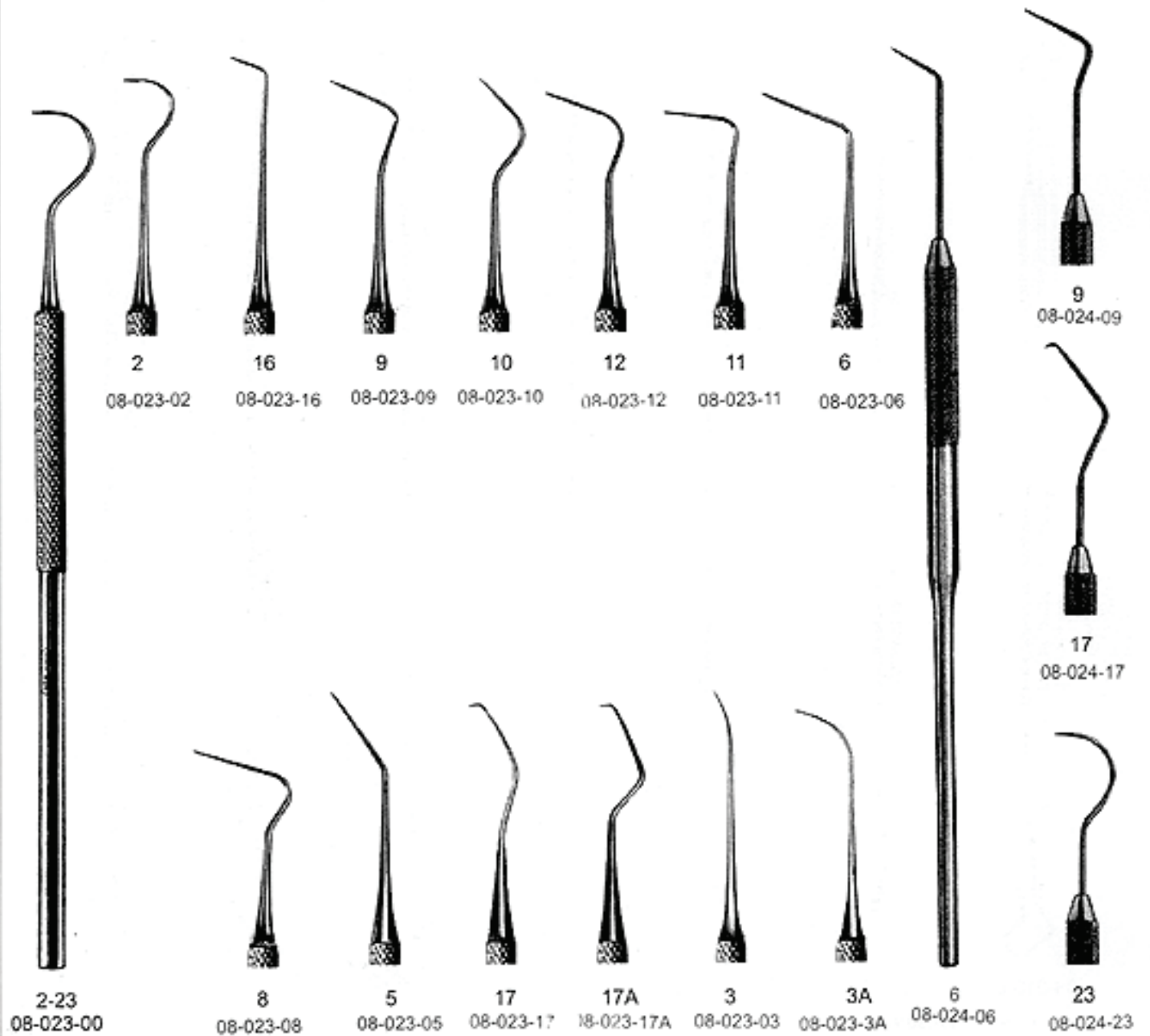

Department

09

ENDODONTIC AND NERVE INSTRUMENTS
INSTRUMENTS A NERFS
NERVINSTRUMENTE

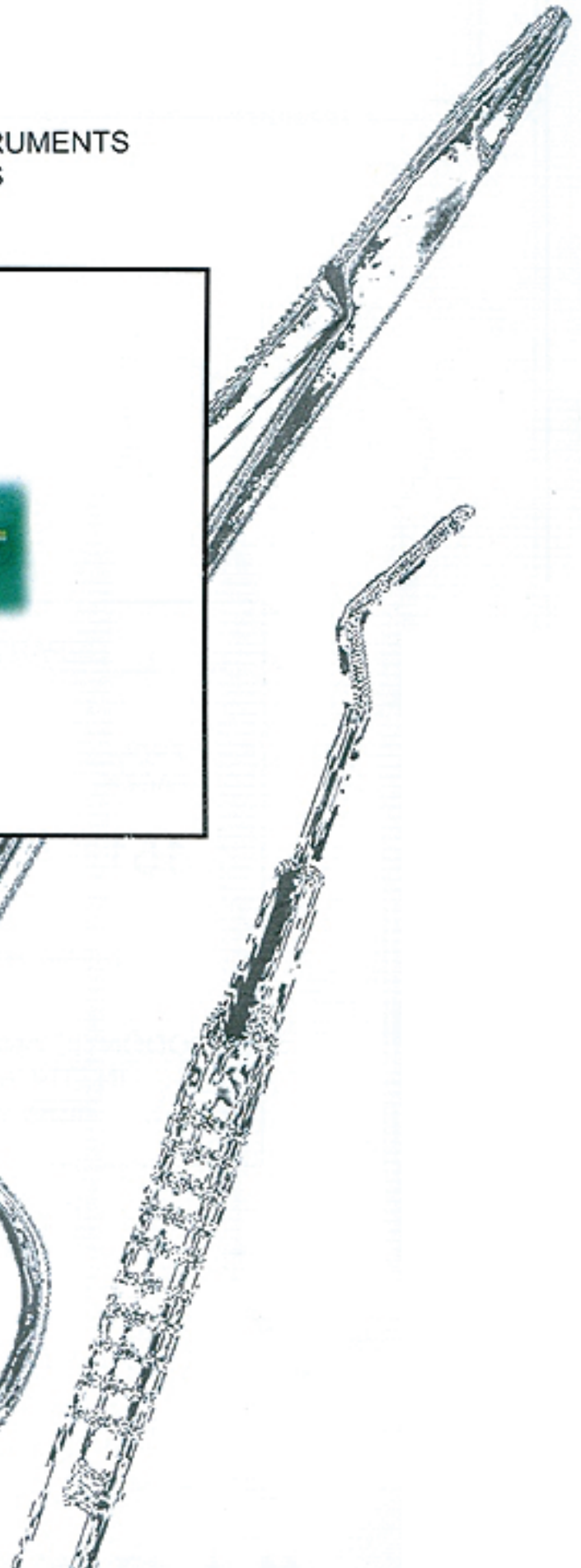
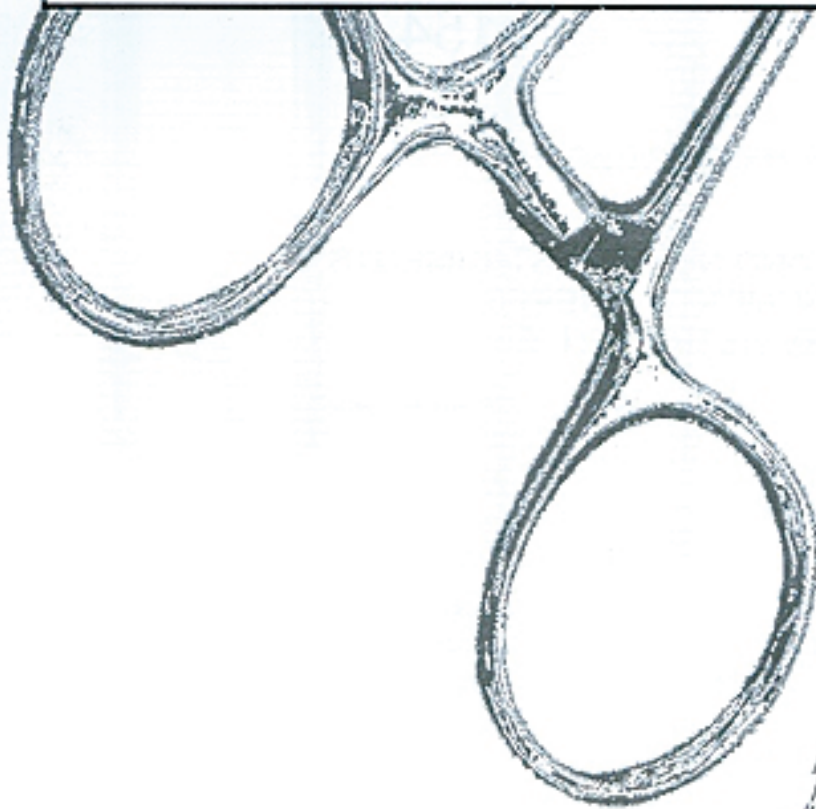
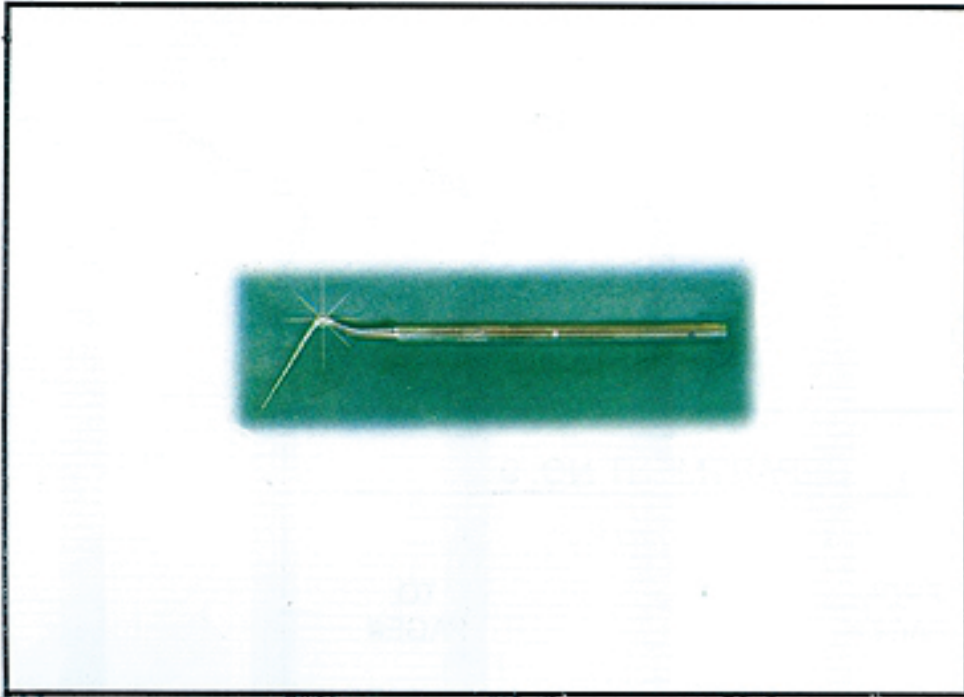

DEPARTMENT NO. 9

FROM
PAGE#

151

TO
PAGE#

154

INSTRUMENTS CATEGORY

ENDODONTIC AND NERVE INSTRUMENTS
INSTRUMENTS A NERFS
NERVINSTRUMENTE

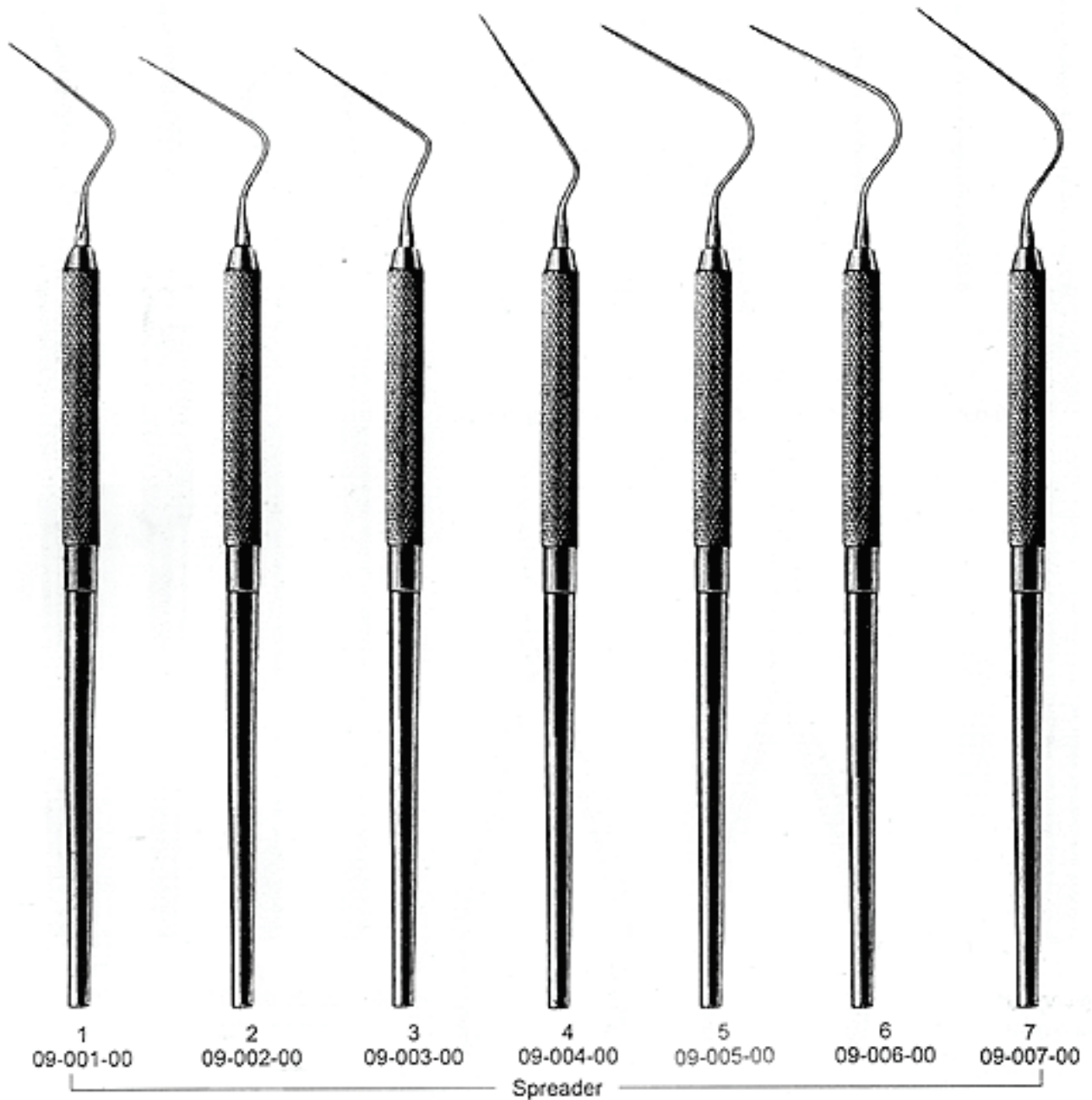

ENDODONTIC AND NERVE INSTRUMENTS
INSTRUMENTS A NERFS
NERVINSTRUMENTE

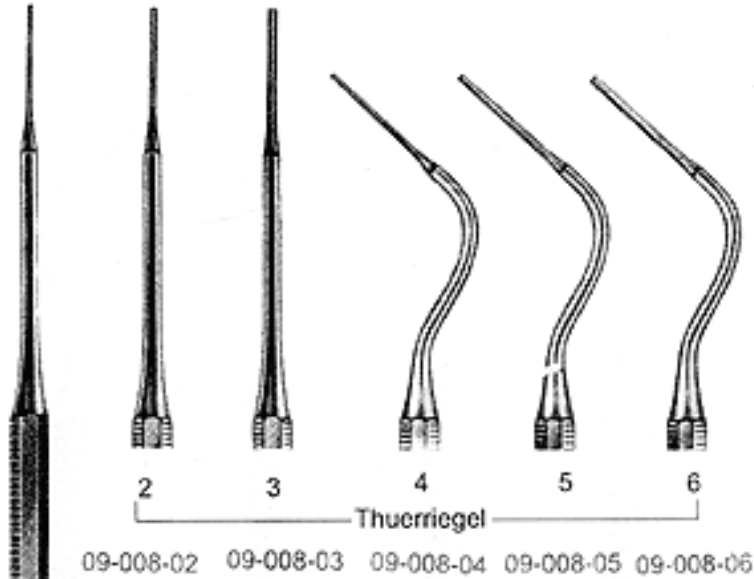

09-008-02 09-008-03 09-008-04 09-008-05 09-008-06

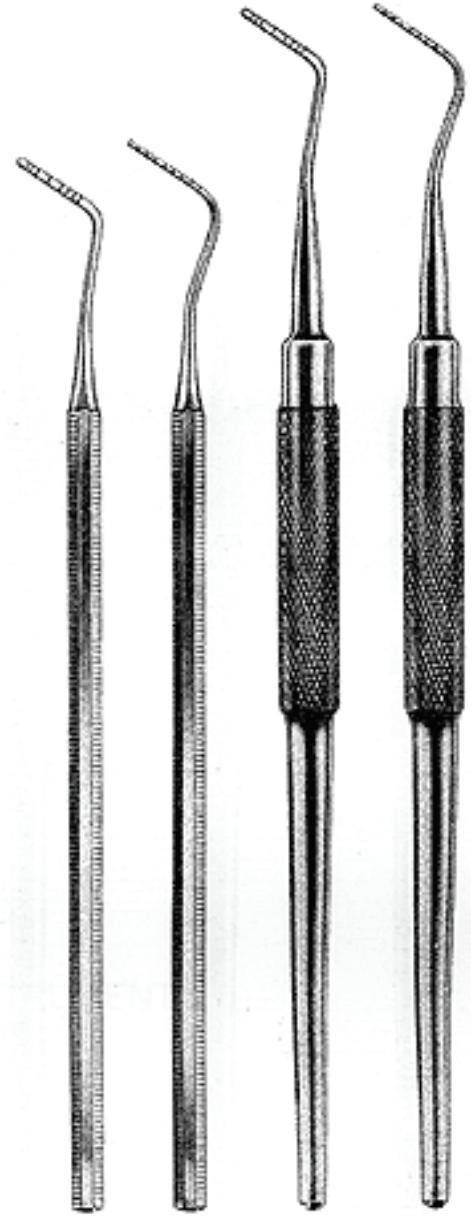

09-011-00 09-012-00 09-013-00 09-014-00
Williams

1-6
09-008-01
Thuerriegel

2/3



1
09-009-15
15 cm



2/3

2
09-010-15
15 cm



Williams
09-015-00



Goldman-Fox
09-016-00



Goldman-Fox
Williams
09-017-00



Goldman-Fox
Williams
09-018-00

PERIODONTAL POCKET PROBES
PARODONTOMETER
SONDAS CALIBRADAS



Off Set
Williams De
09-019-00



Nabers
09-020-00



23/QW
Williams
09-021-00



09-022-00



BASIC SET
GRUNDLEGENDER SATZ
EL CONJUNTO BASICO



Basic Set in Pouch Consisting of Following Instruments

Mirror No. 5 with handle
Excavator No. 17
Explorer No. 5
College Tweezer Serrated 15 cm
09-051-00

Department

10

CEMENT SPATULAS
SPATULES A CIMENT
ESPATULAS PARA CEMENTO

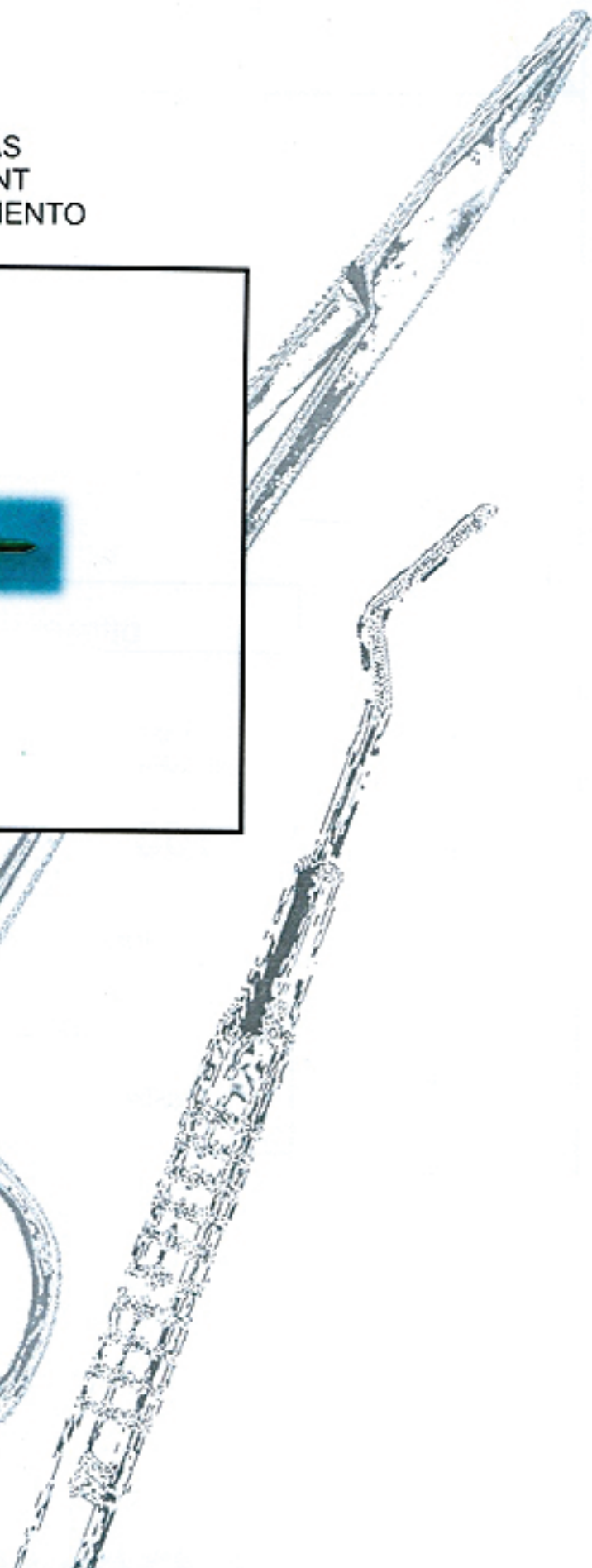
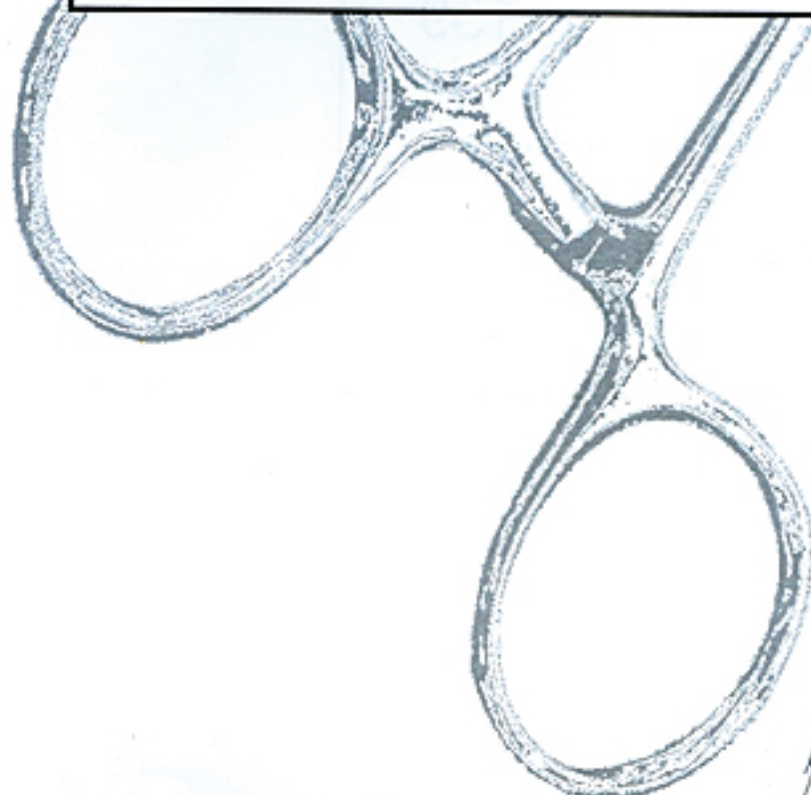
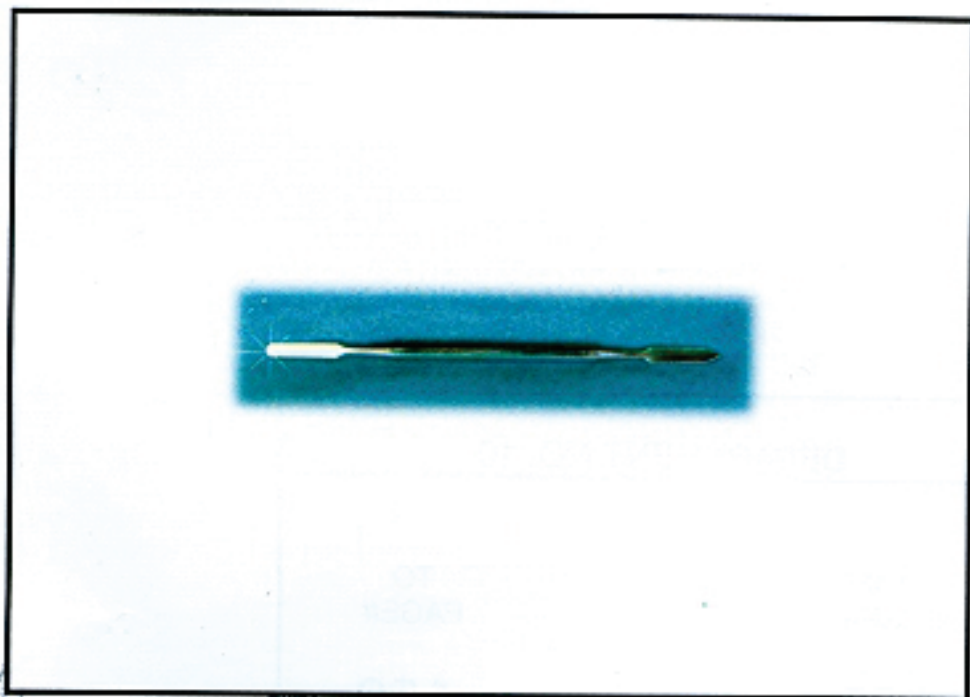

DEPARTMENT NO. 10

FROM
PAGE#

155

TO
PAGE#

159

INSTRUMENTS CATEGORY

CEMENT SPATULAS
SPATULES A CIMENT
ESPATULAS PARA CEMENTO

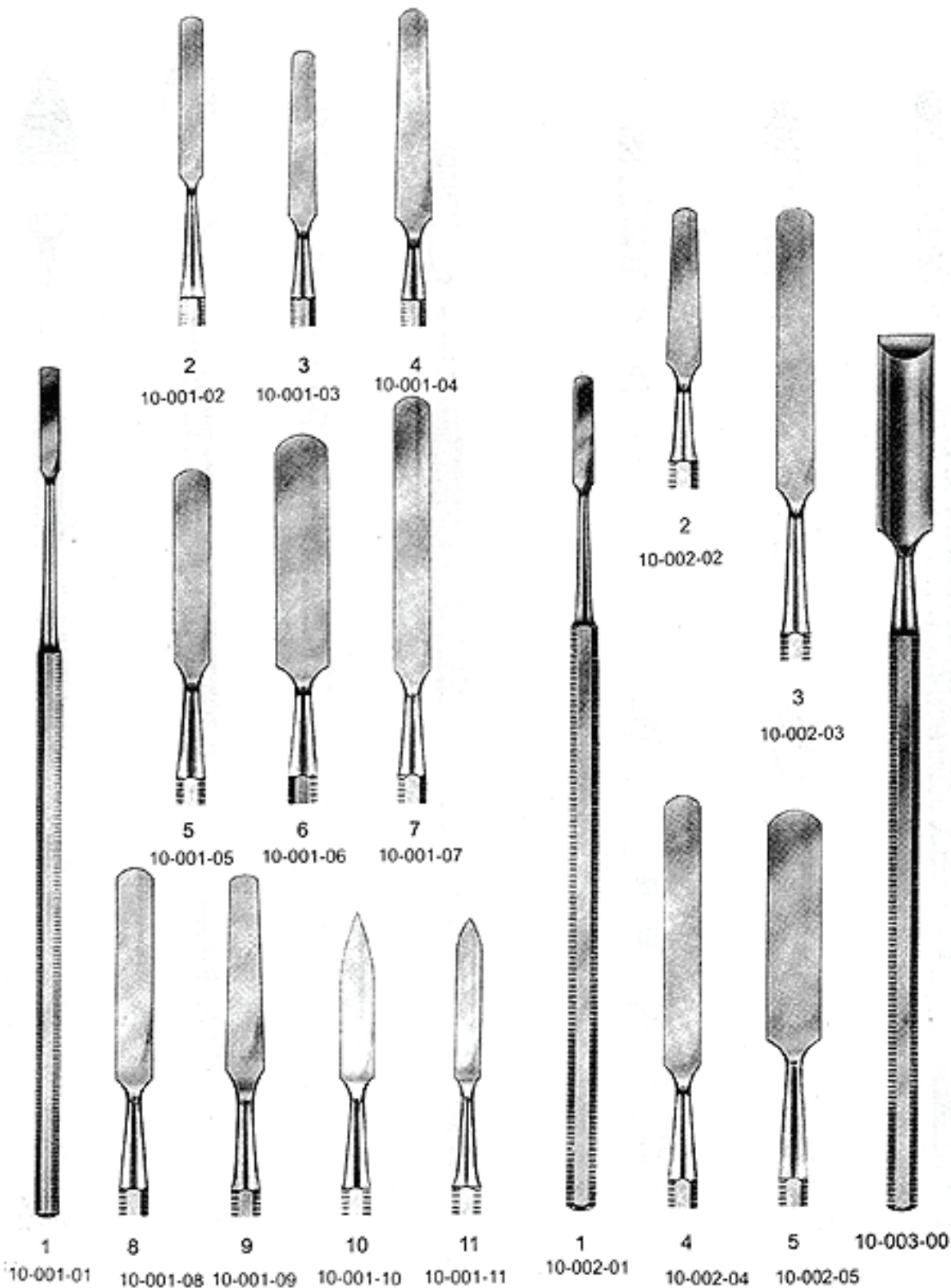
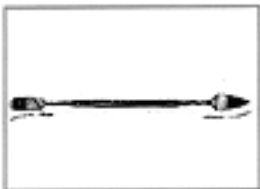

CEMENT SPATULAS
SPATULES A CIMENT
ESPATULAS PARA CEMENTO

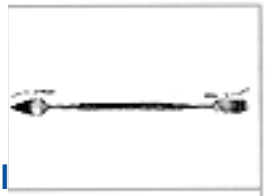

1
10-004-01



2
10-004-02



3
10-004-03



4
10-004-04



5
10-004-05



1
10-005-00



2
10-006-00



3
10-007-00

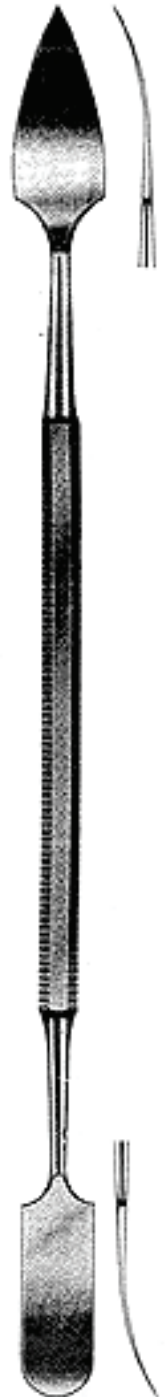

Gritman 31
10-008-00

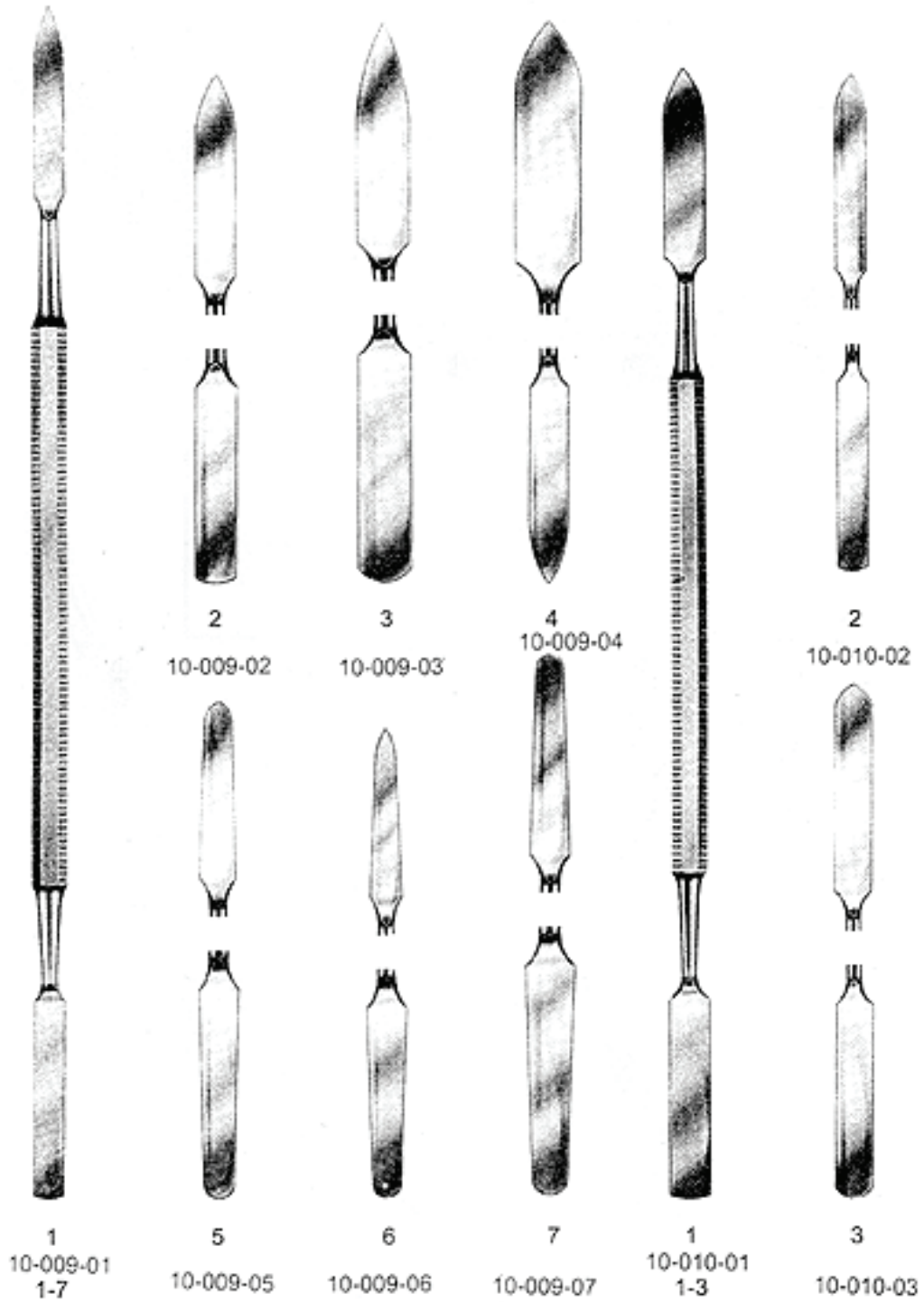

Department

11

AMALGAM INSTRUMENTS
AMALGAM INSTRUMENTE
INSTRUMENTOS PARA AMALGAM



DEPARTMENT NO. 11

FROM
PAGE#

160

TO
PAGE#

168

INSTRUMENTS CATEGORY

AMALGAM INSTRUMENTS
AMALGAM INSTRUMENTE
INSTRUMENTOS PARA AMALGAM

CEMENT SPATULAS
SPATULES A CIMENT
ESPATULAS PARA CEMENTO

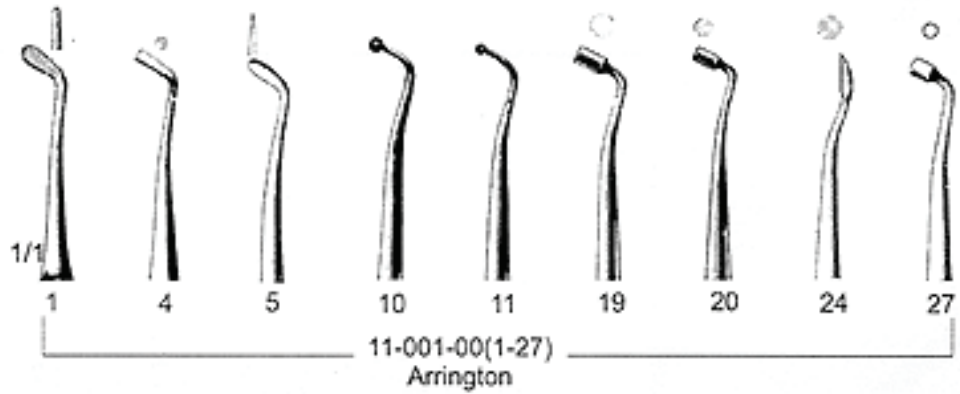

11-001-01 11-001-04 11-001-05 11-001-10 11-001-11 11-001-19 11-001-20 11-001-24 11-001-27

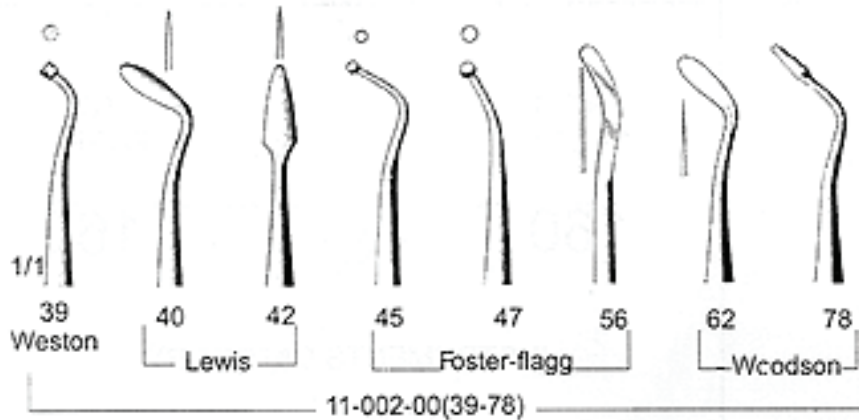

11-002-39 11-002-40 11-002-42 11-002-45 11-002-47 11-002-56 11-002-62 11-002-78

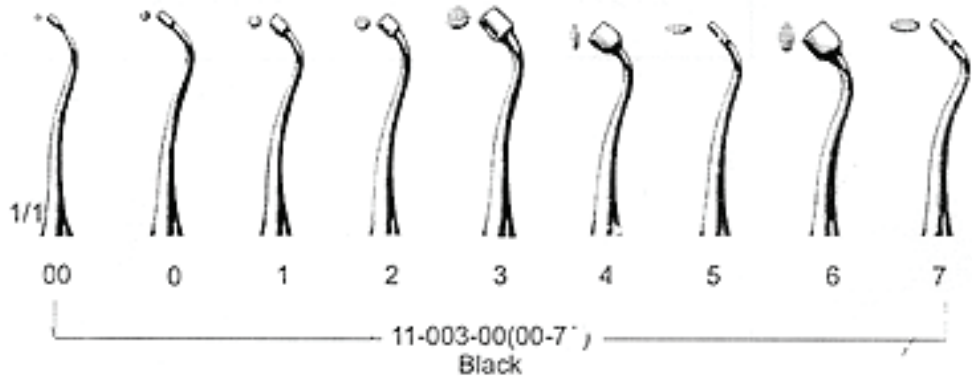

11-003-40 11-003-20 11-003-01 11-003-02 11-003-03 11-003-04 11-003-05 11-003-06 11-003-07

1
11-001-00(1-27)
11-002-00(39-78,
11-003-00(00-7)

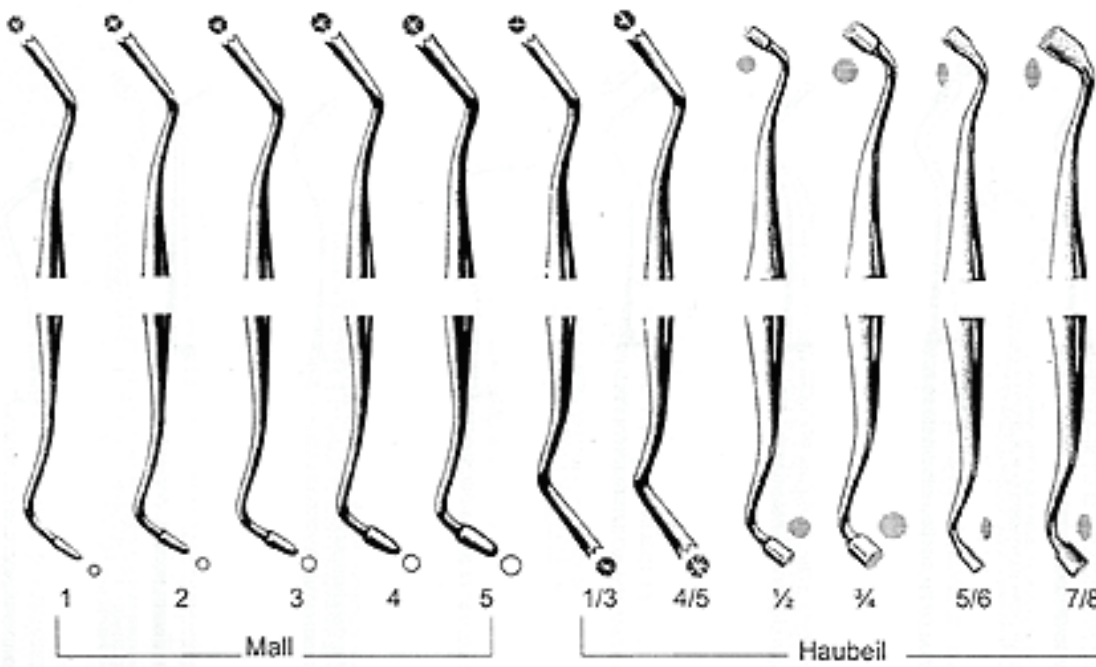

11-004-00(1-7/8)

11-004-01 11-004-02 11-004-03 11-004-04 11-004-05 11-004-1/3 11-004-4/5 11-004-1/2 11-004-3/4 11-004-5/6 11-004-7/8

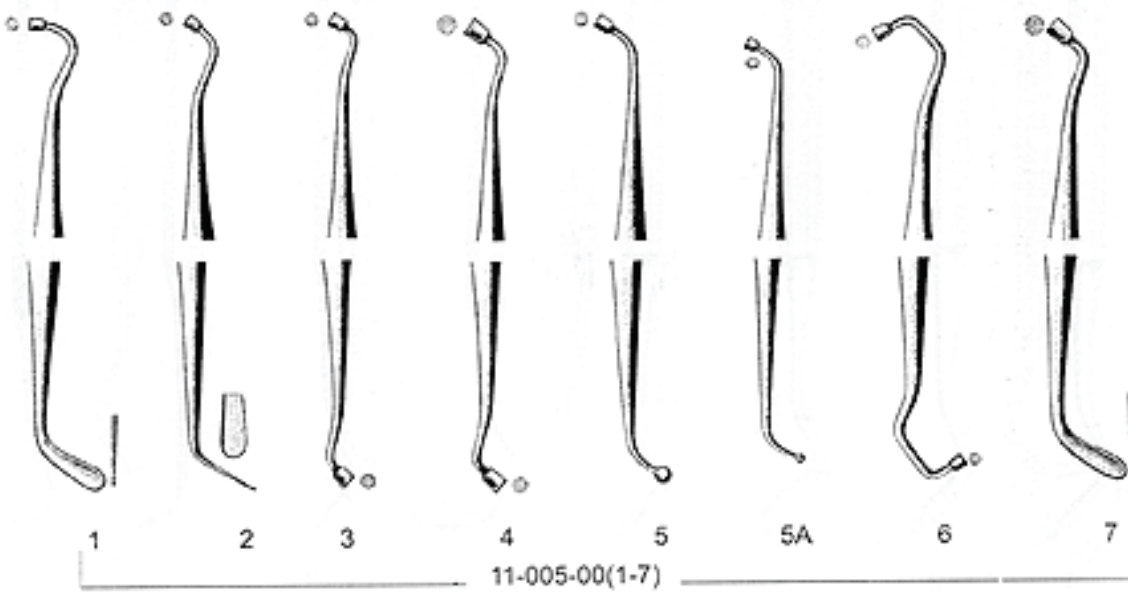

11-005-00(1-7)
 Modell-Amalg

11-005-01 11-005-02 11-005-03 11-005-04 11-005-05 11-005-5A 11-005-06 11-005-07

1
 11-004-00(1-7/8)
 11-005-00(1-7)

AMALGAM INSTRUMENTS
AMALGAM INSTRUMENTE
INSTRUMENTOS PARA AMALGAM

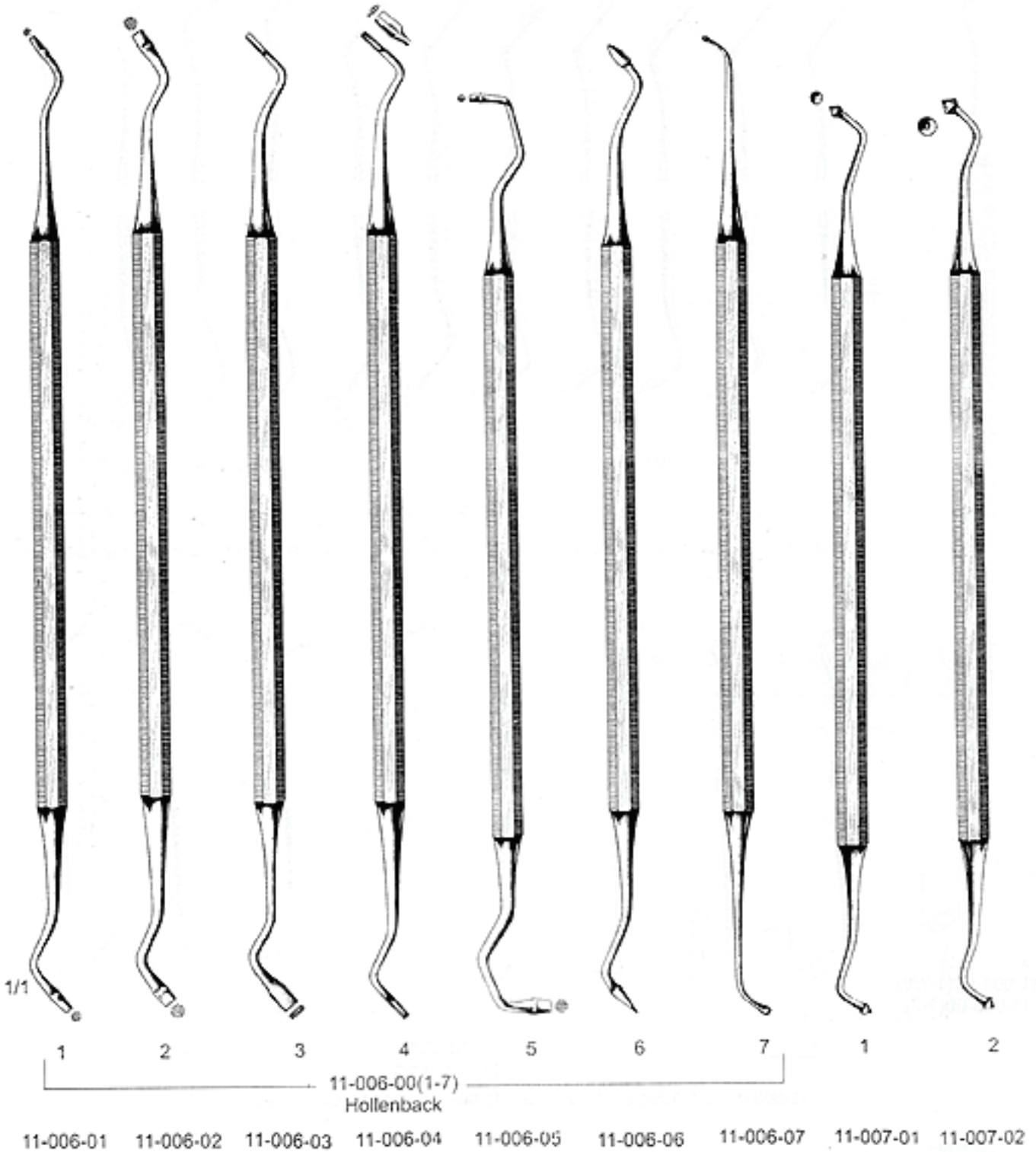

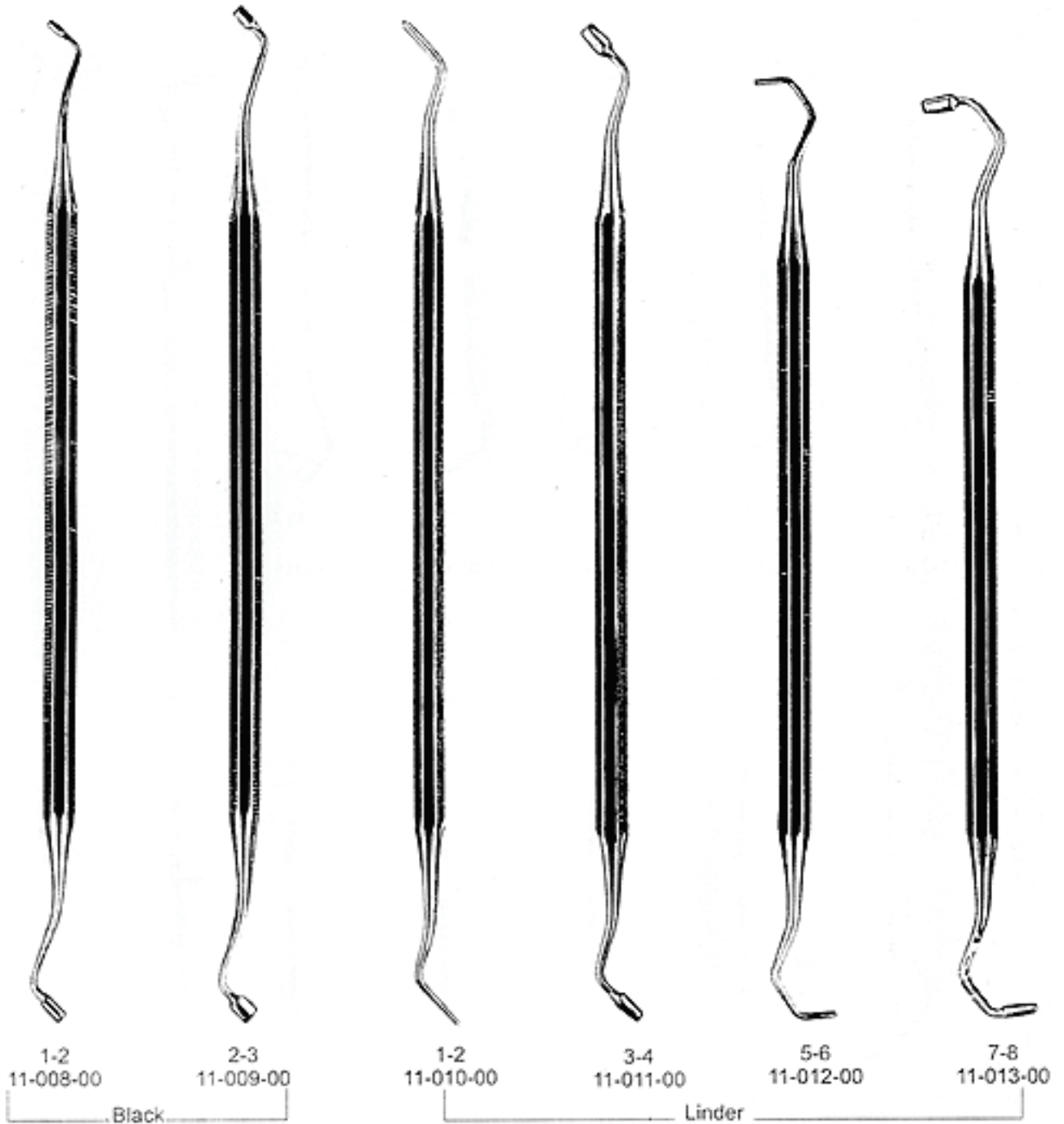

AMALGAM INSTRUMENTS
AMALGAM INSTRUMENTE
INSTRUMENTOS PARA AMALGAM

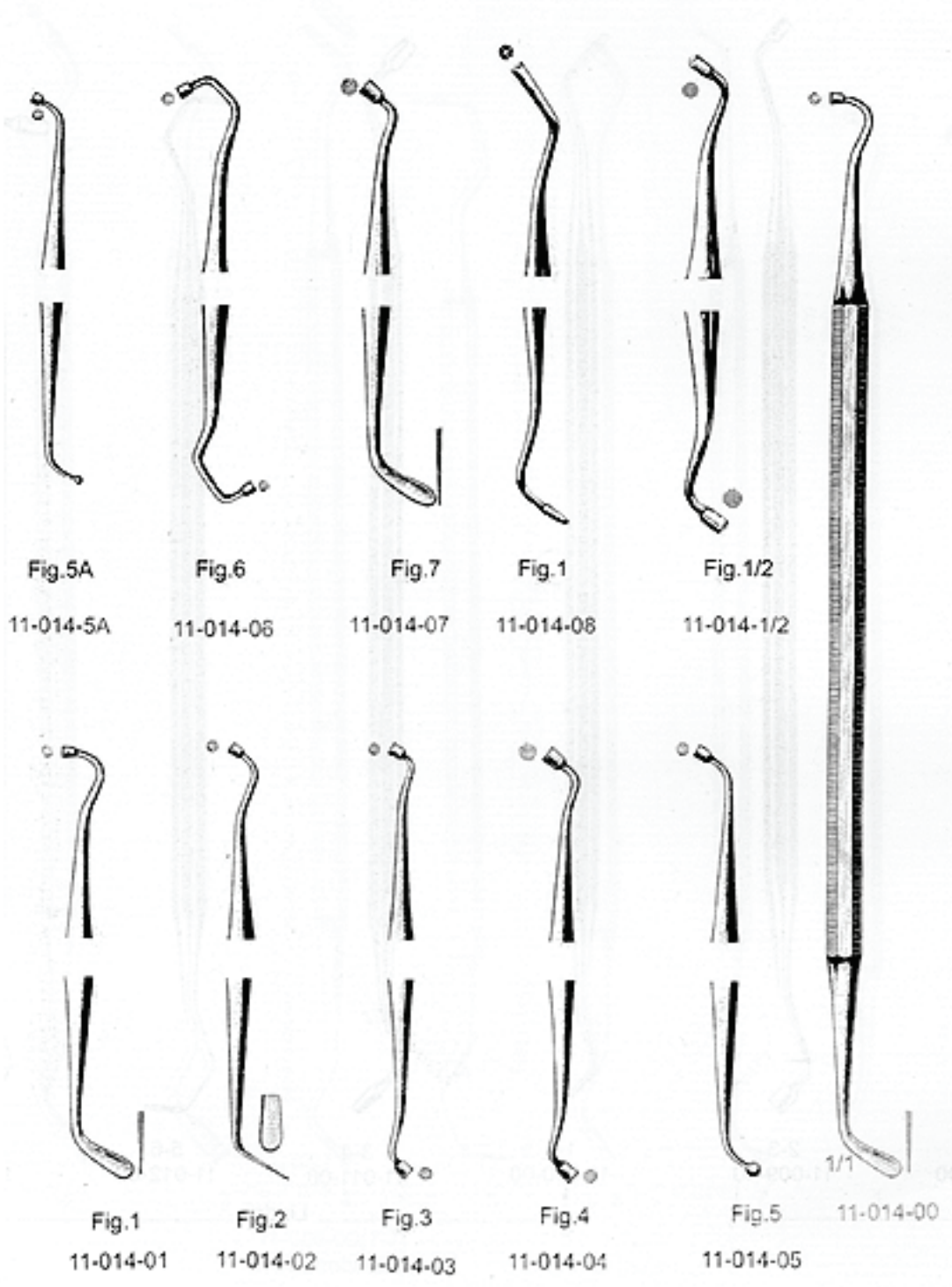



WA-4
11-015-00
Wallis-4



WI-4
11-016-00
William-4



11-017-00
Porcelain



11-018-00
Pelar Carver



11-019-00
Nystrom Cervical

AMALGAM CARVER
 INSTRUMENTE ZUM MODELLIEREN VON FULLUNGEN
 INSTRUMENTOS PARA MODELAR LAS OBTURACIONES

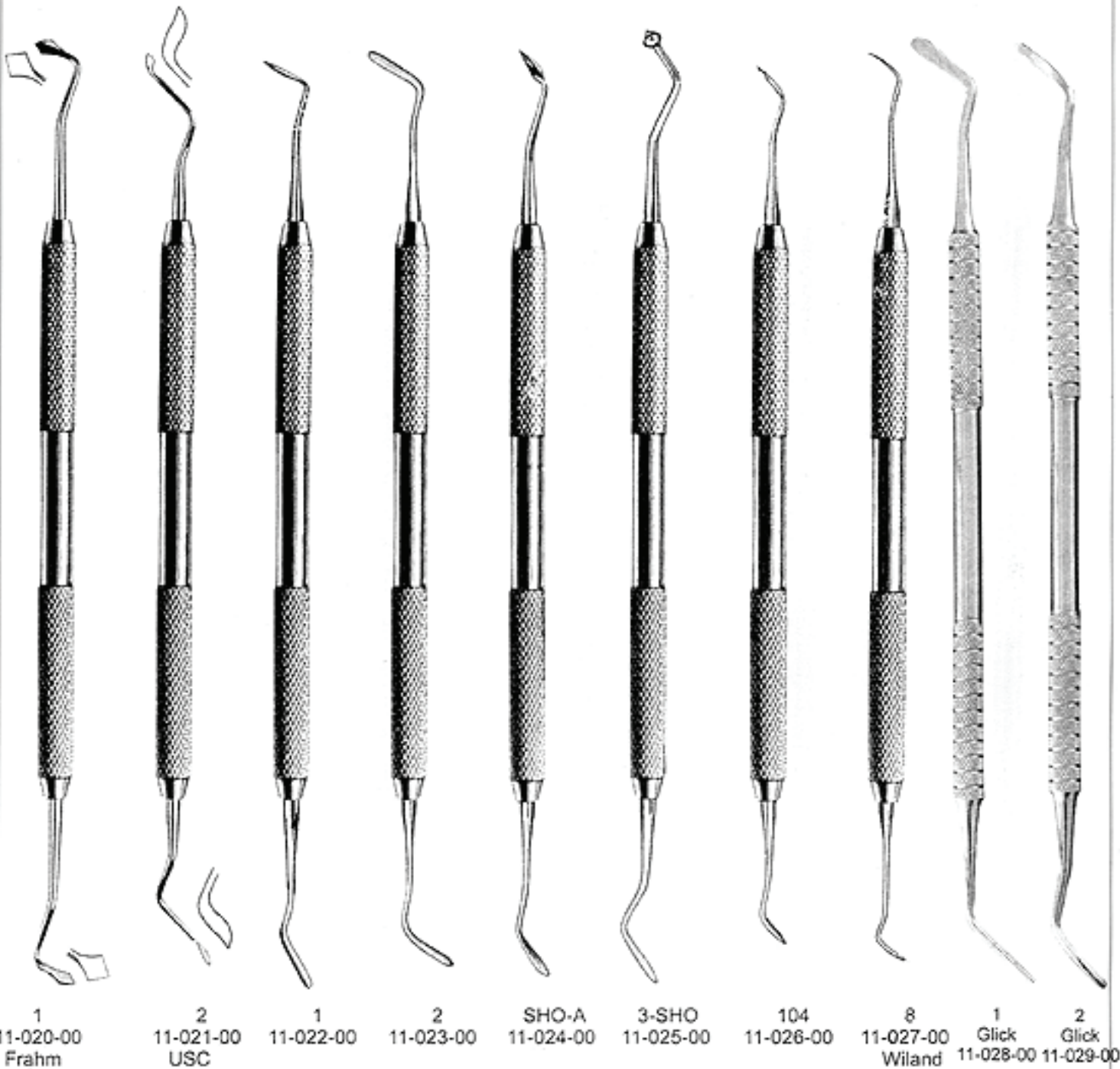

Department

12

BONE CURETTES
SCHARFE LOFFEL
CURETAS OSEAS

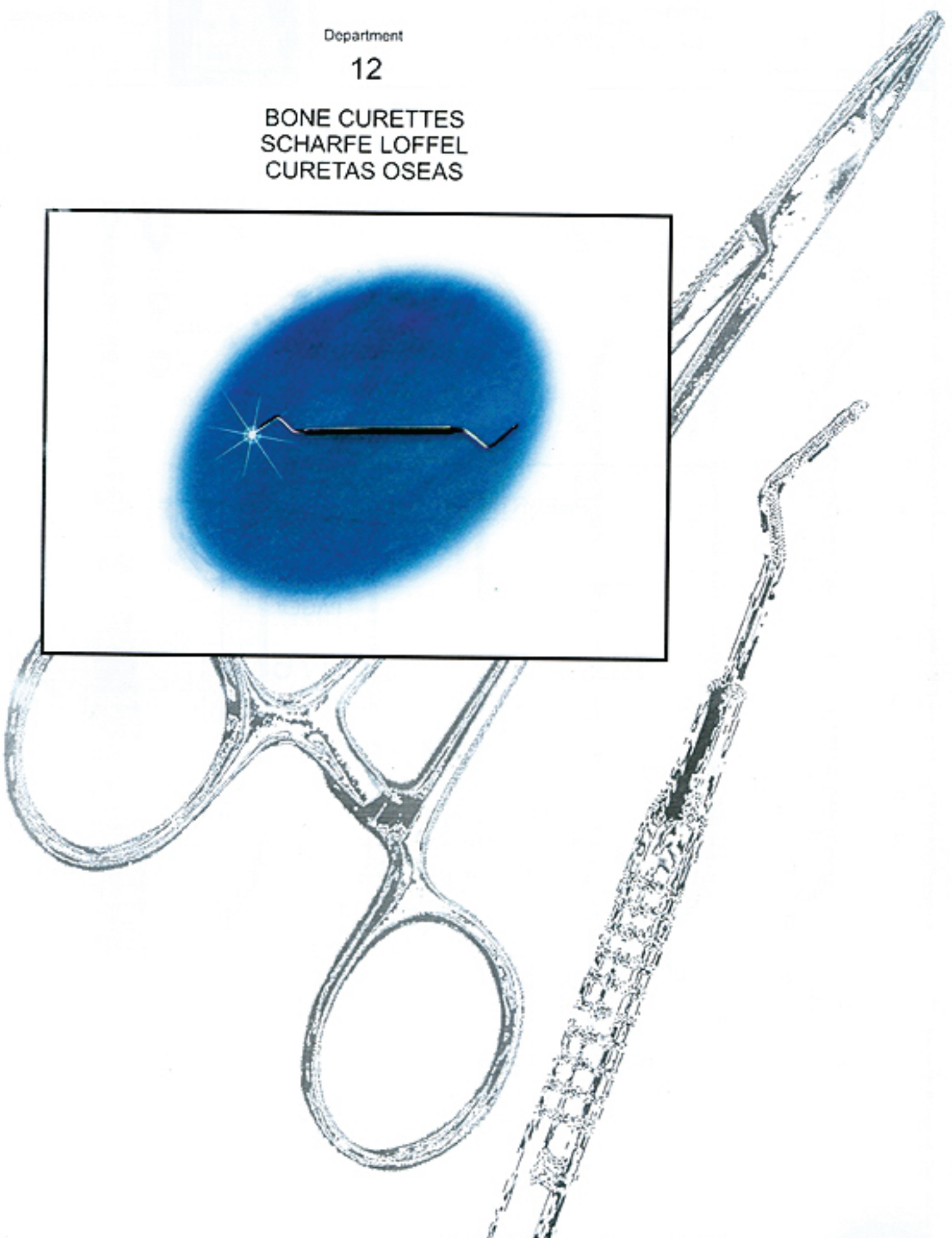

DEPARTMENT NO. 12

FROM
PAGE#

169

TO
PAGE#

176

INSTRUMENTS CATEGORY

BONE CURETTES
SCHARFE LOFFEL
CURETAS OSEAS

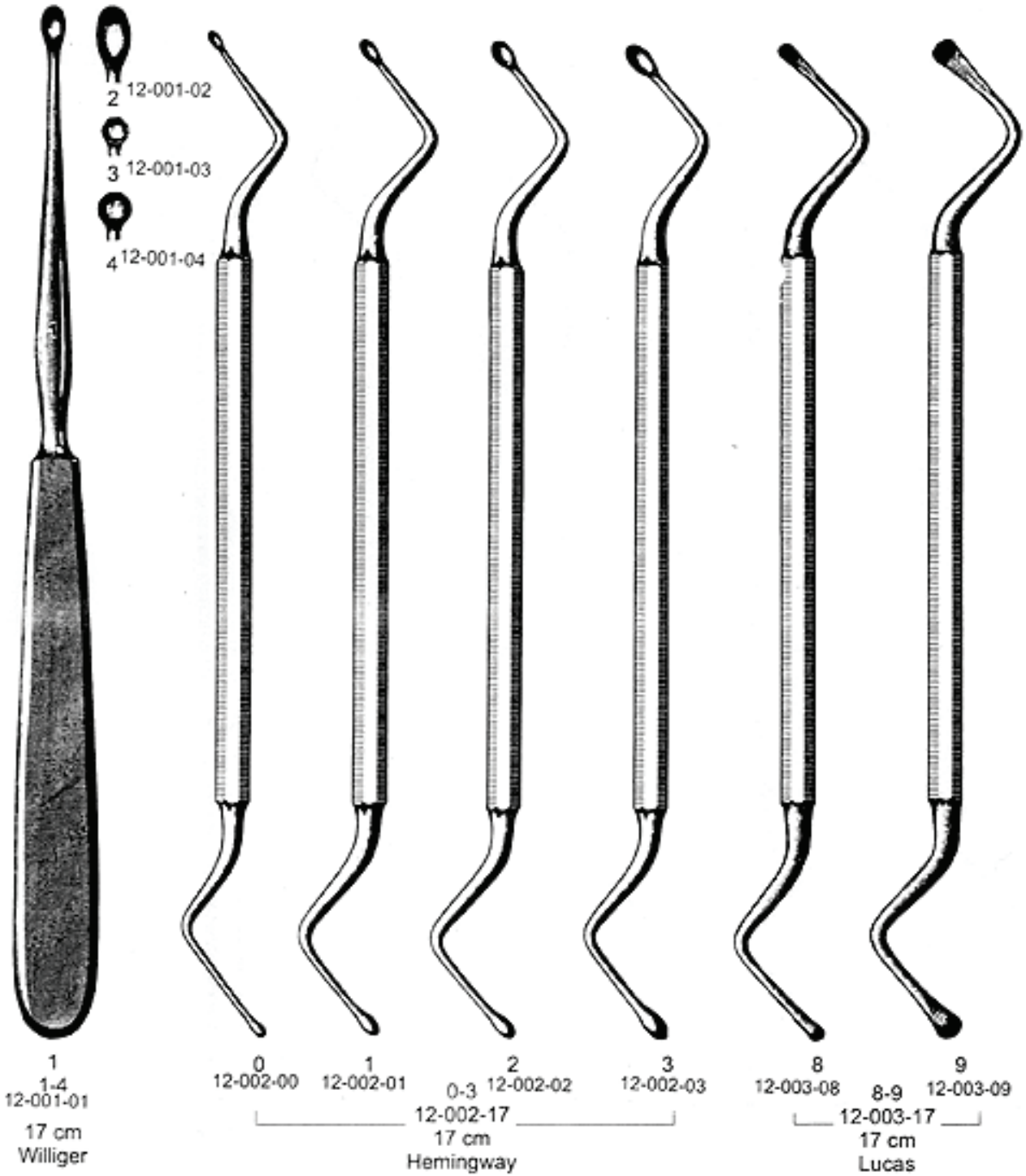

BONE CURETTES
SCHARFE LOFFEL
CURETAS OSEAS



1
12-004-17
17 cm



2
12-005-17
17 cm

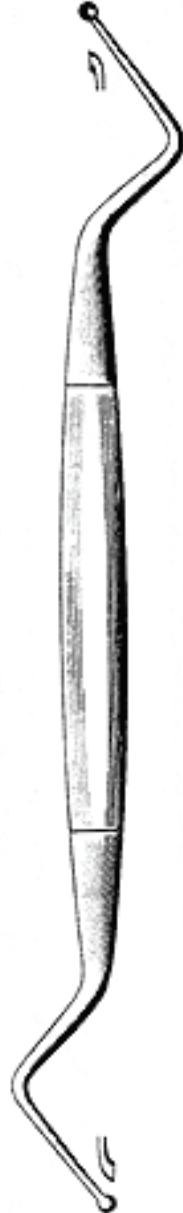

1
12-006-00



2
12-007-00



2
12-008-00
Parsch



12-009-17
17 cm

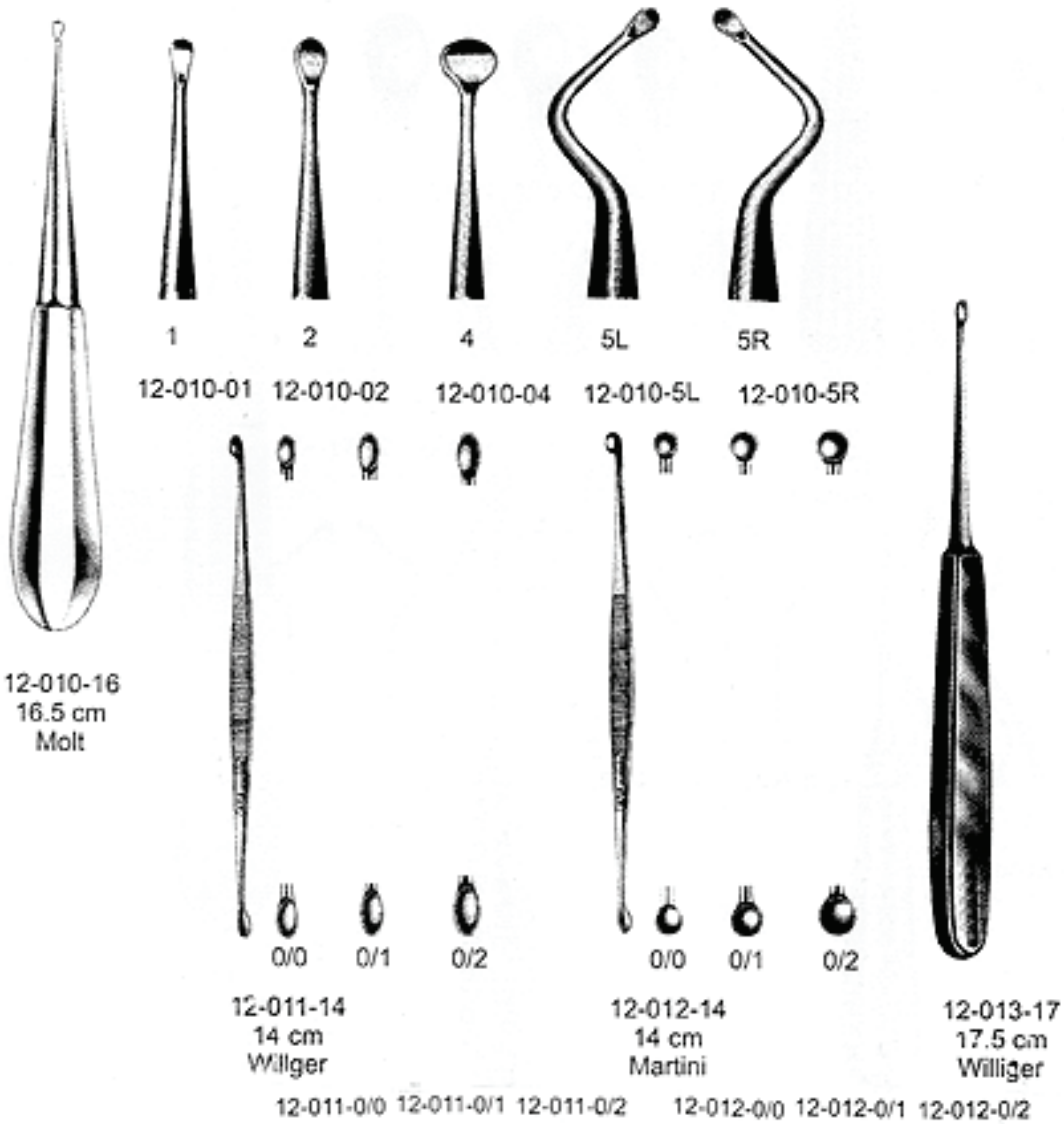

BONE CURETTES
SCHARFE LOFFEL
CURETAS OSEAS



12-014-17
17 cm
Volkman

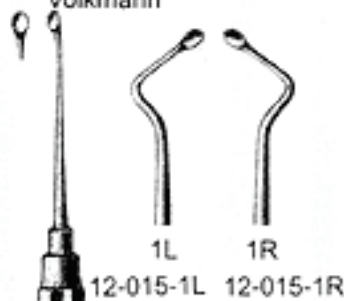

1
12-015-16
16 cm
U.S.A. Model

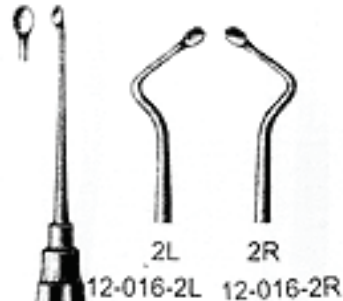

2
12-016-16
16 cm
U.S.A. Model



1-8
 12-017-14
 14 cm
 Kerpel



2

17-017-02



3

17-017-03



5

17-017-05



7

12-017-07



8

12-017-08



1-8
 12-018-14
 14 cm



1

12-018-01



4

12-018-04



5

12-018-05



7

12-018-07



8

12-018-08

Department

13

FILLING INSTRUMENTS
INSTRUMENTS POUR PLOMBAGE
INSTRUMENTOS PARA OBTURACIONES

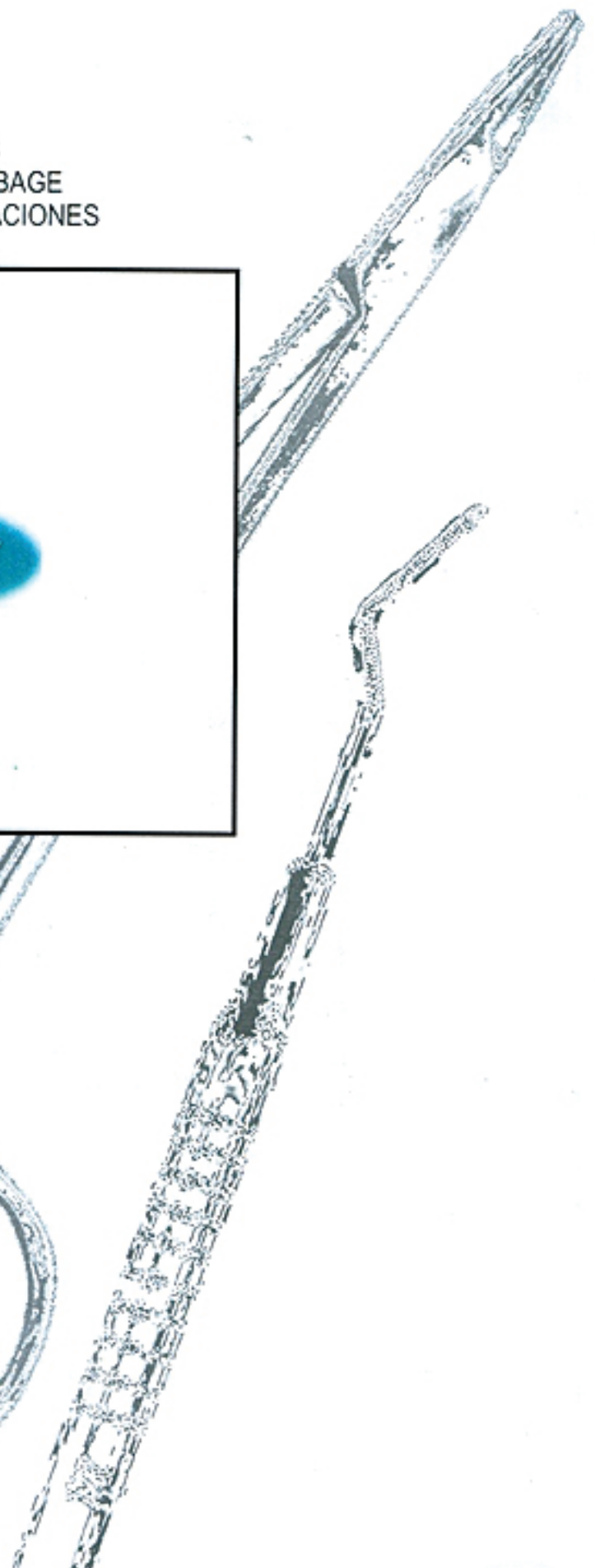
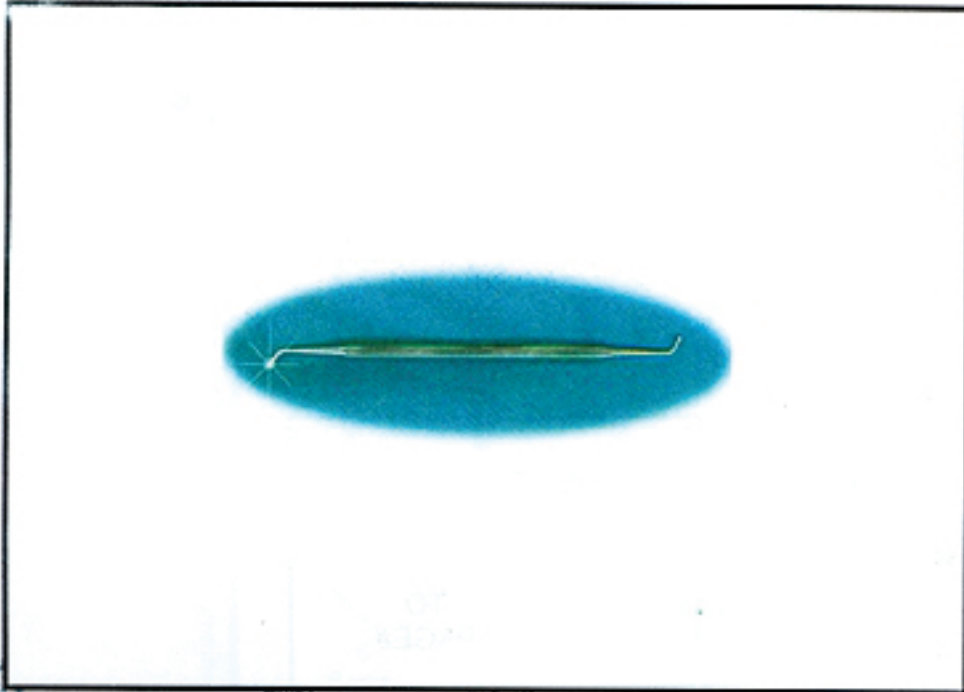

DEPARTMENT NO. 13

FROM
PAGE#

177

TO
PAGE#

206

INSTRUMENTS CATEGORY

FILLING INSTRUMENTS
INSTRUMENTS POUR PLOMBAGE
INSTRUMENTOS PARA OBTURACIONES

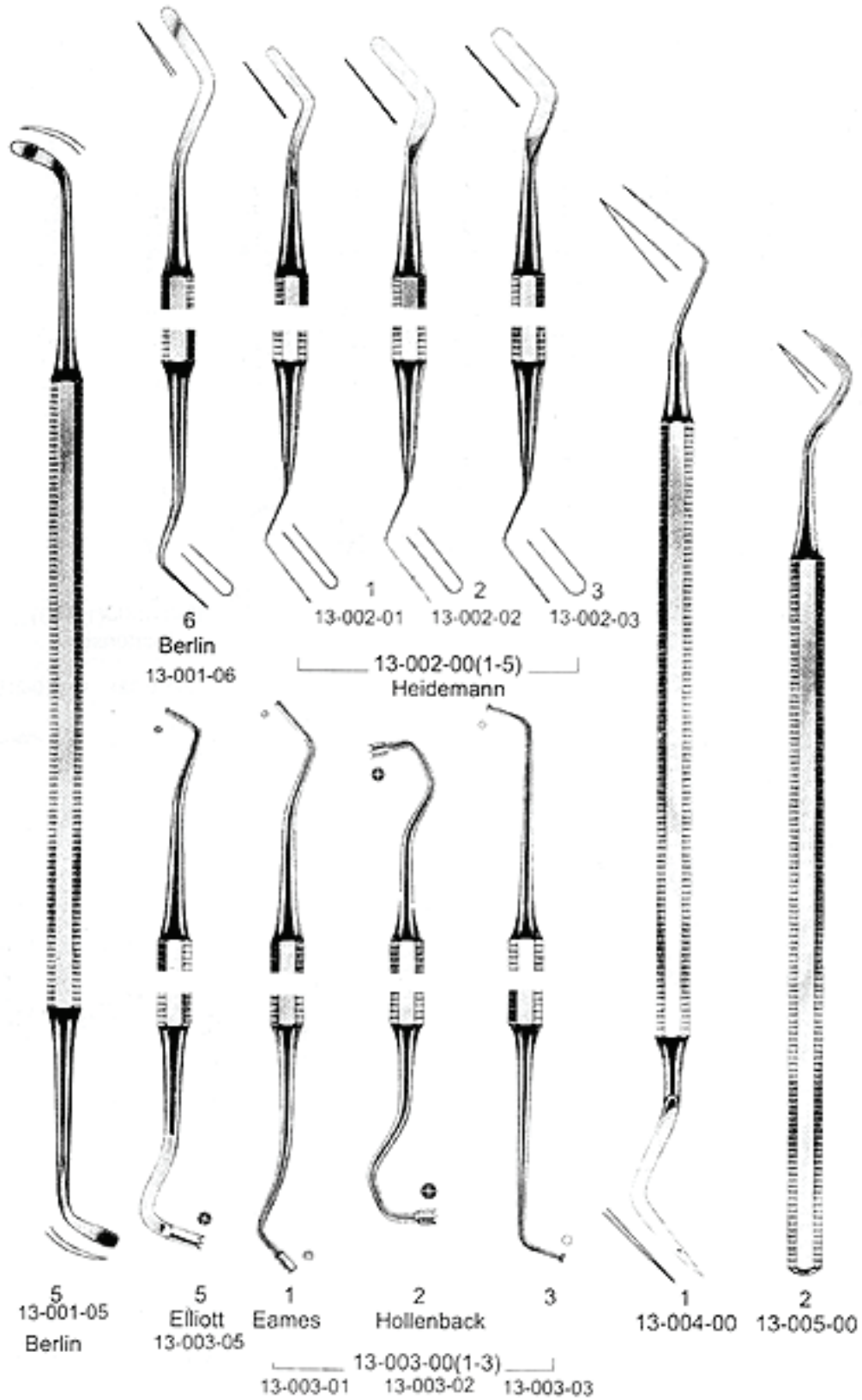

FILLING INSTRUMENTS
 INSTRUMENTS POUR PLOMBAGE
 INSTRUMENTOS PARA OBTURACIONES

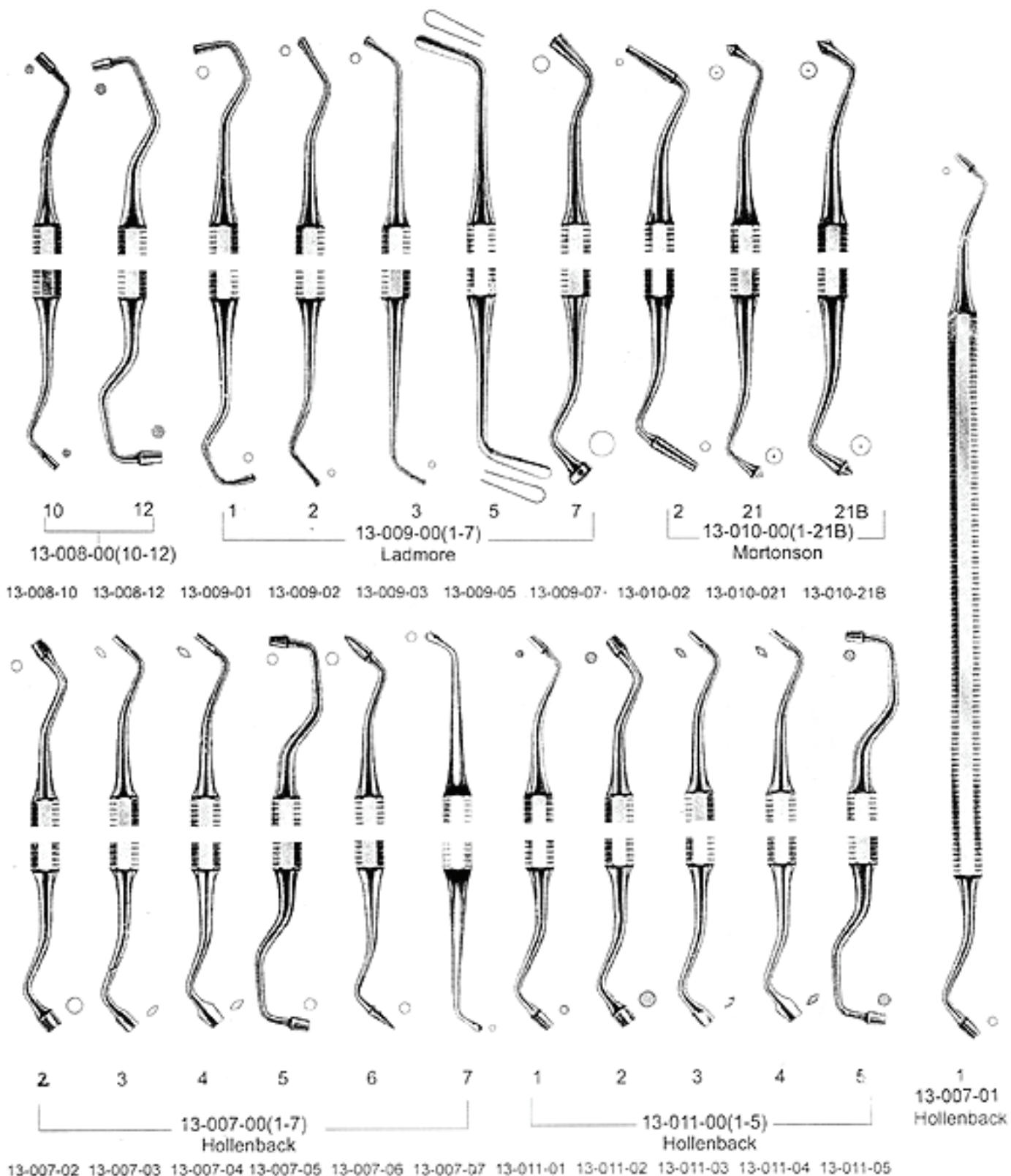

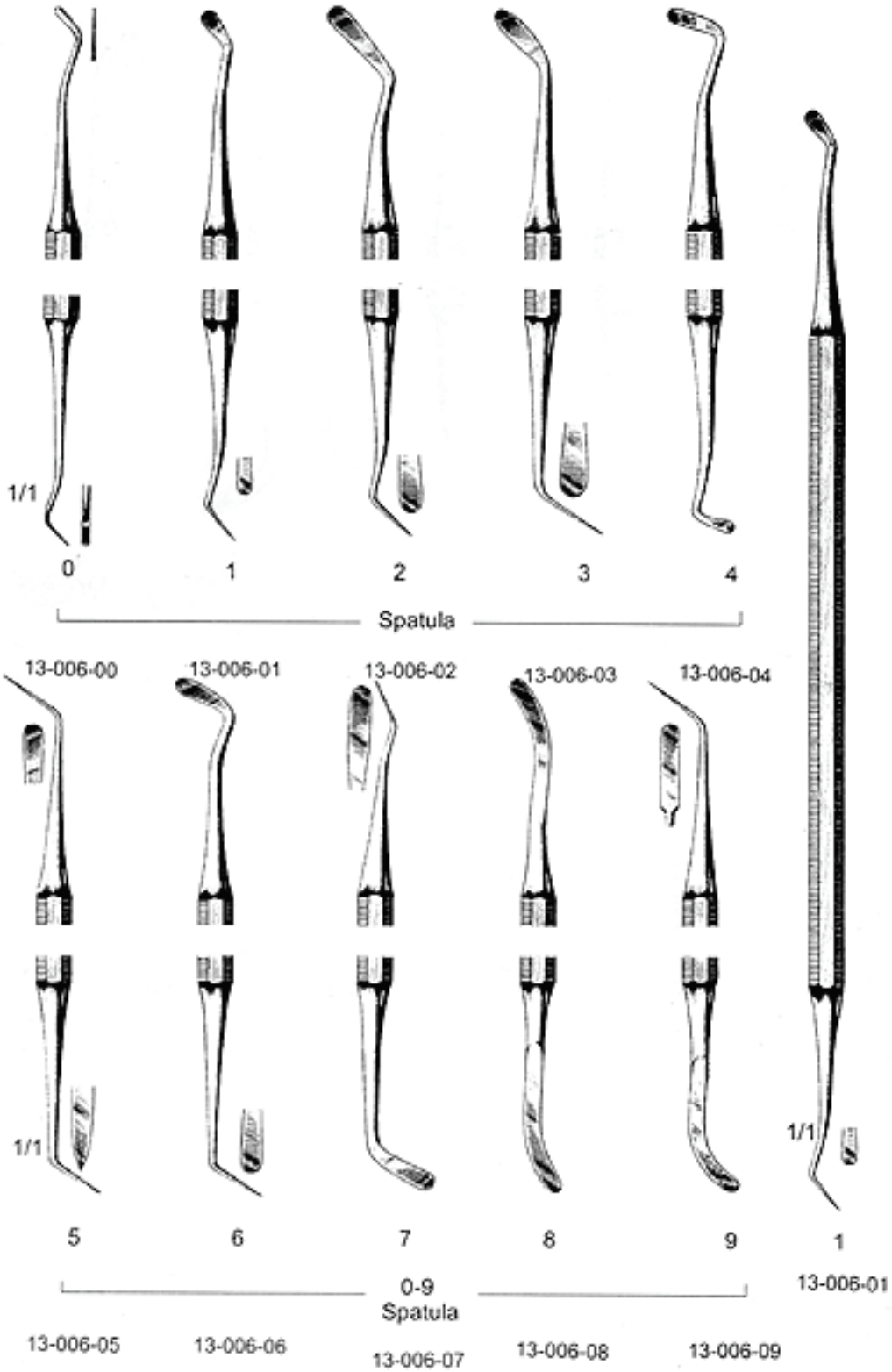

FILLING INSTRUMENTS
INSTRUMENTS POUR PLOMBAGE
INSTRUMENTOS PARA OBTURACIONES

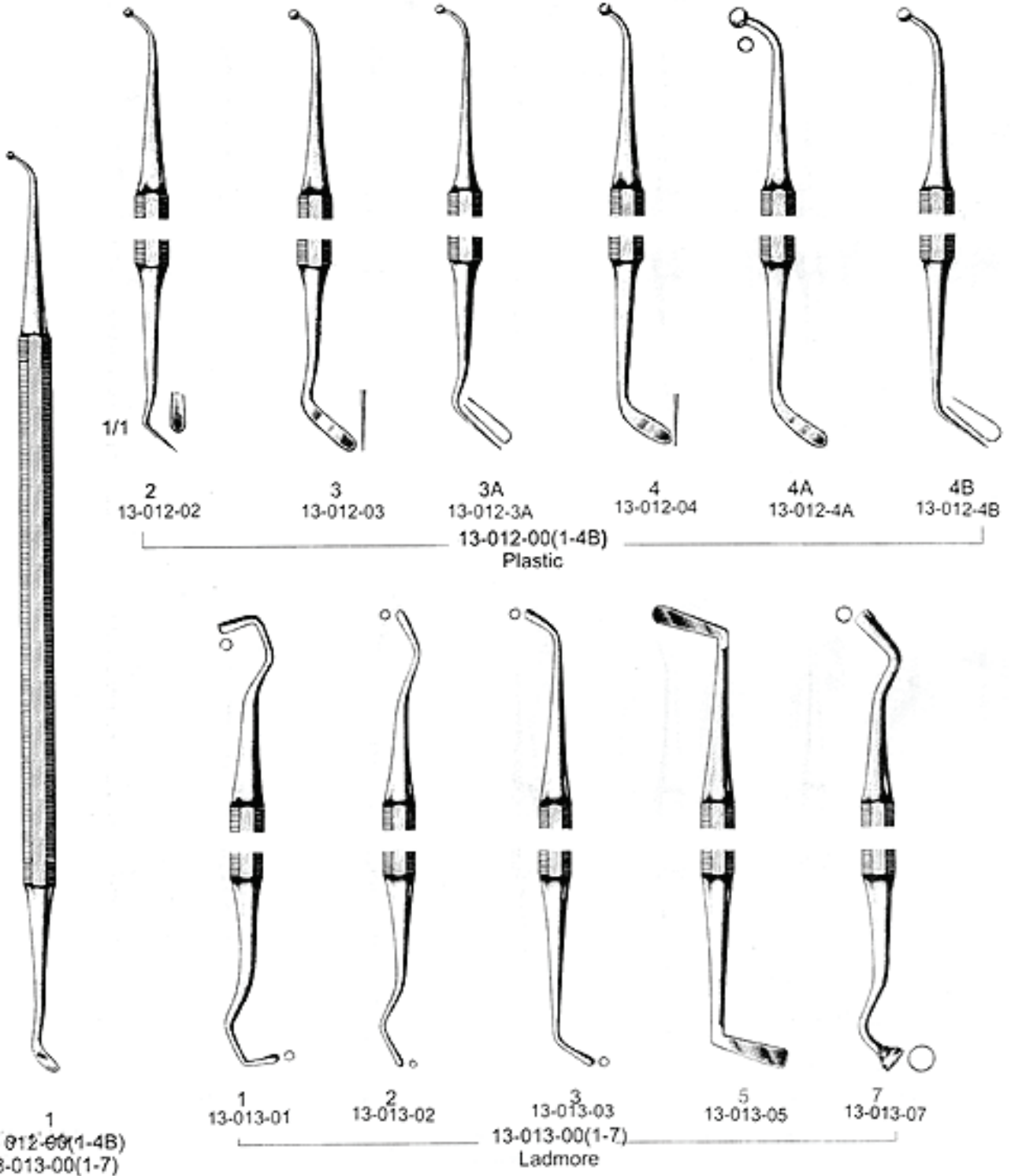

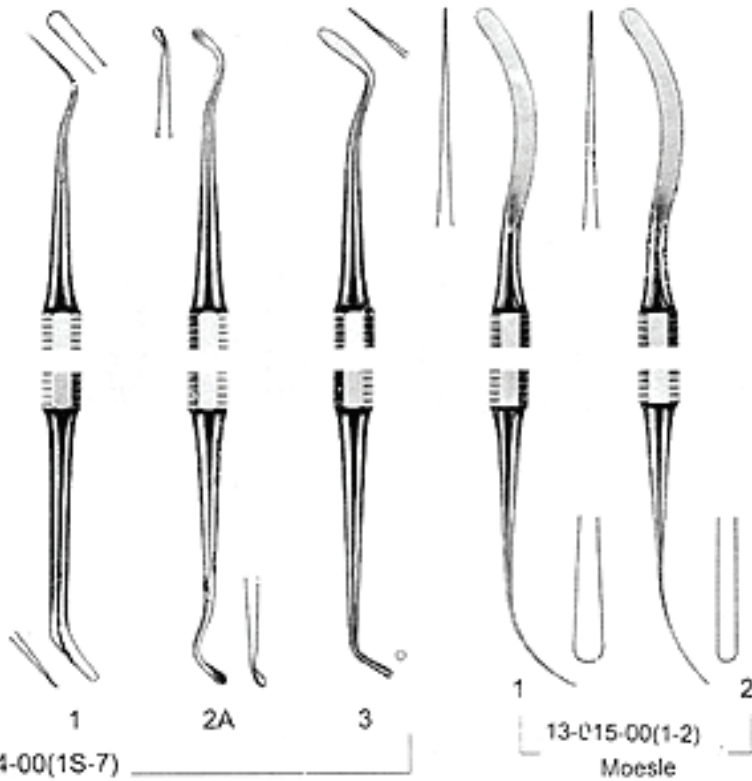

13-014-01 13-014-2A 13-014-03 13-015-A1 13-015-A2

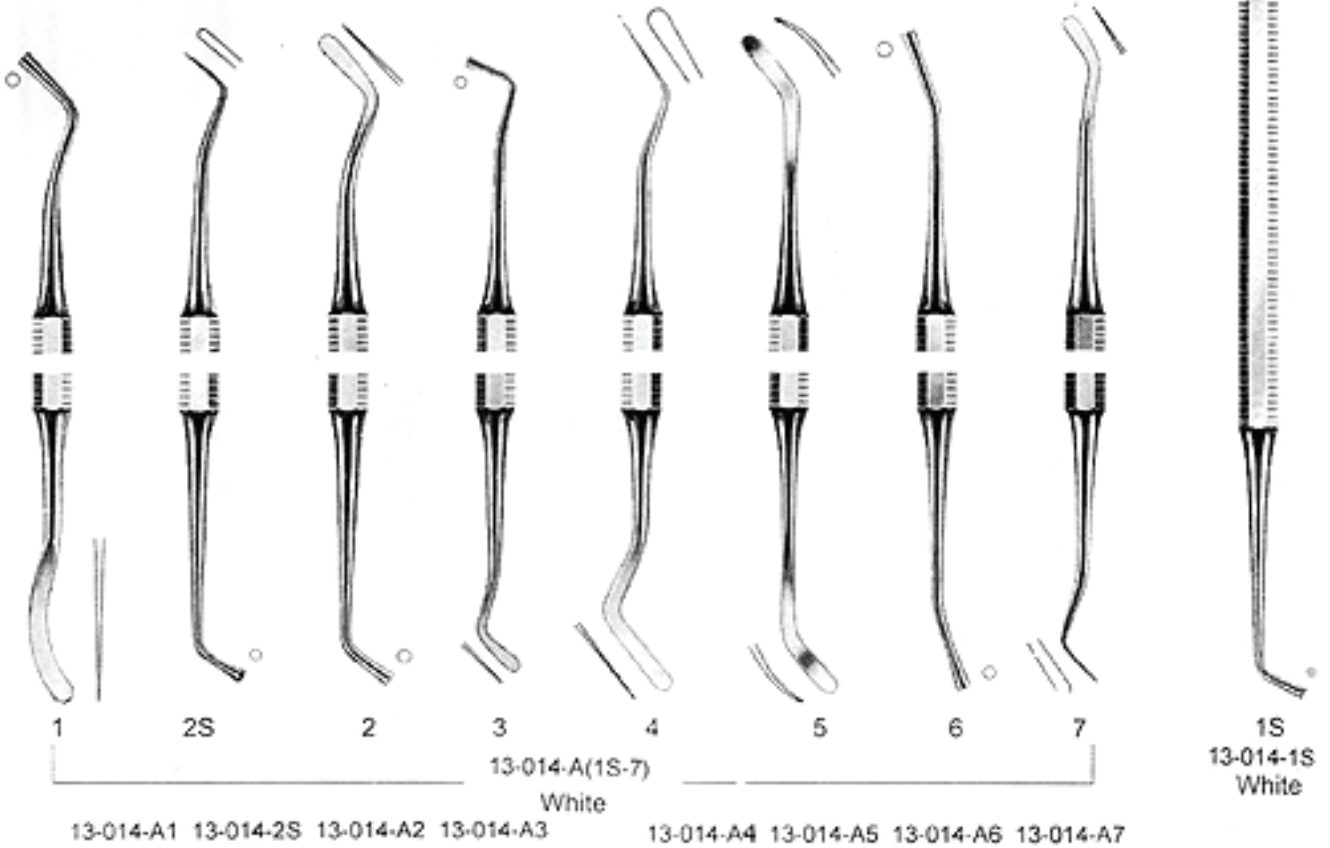

FILLING INSTRUMENTS
 INSTRUMENTS POUR PLOMBAGE
 INSTRUMENTOS PARA OBTURACIONES

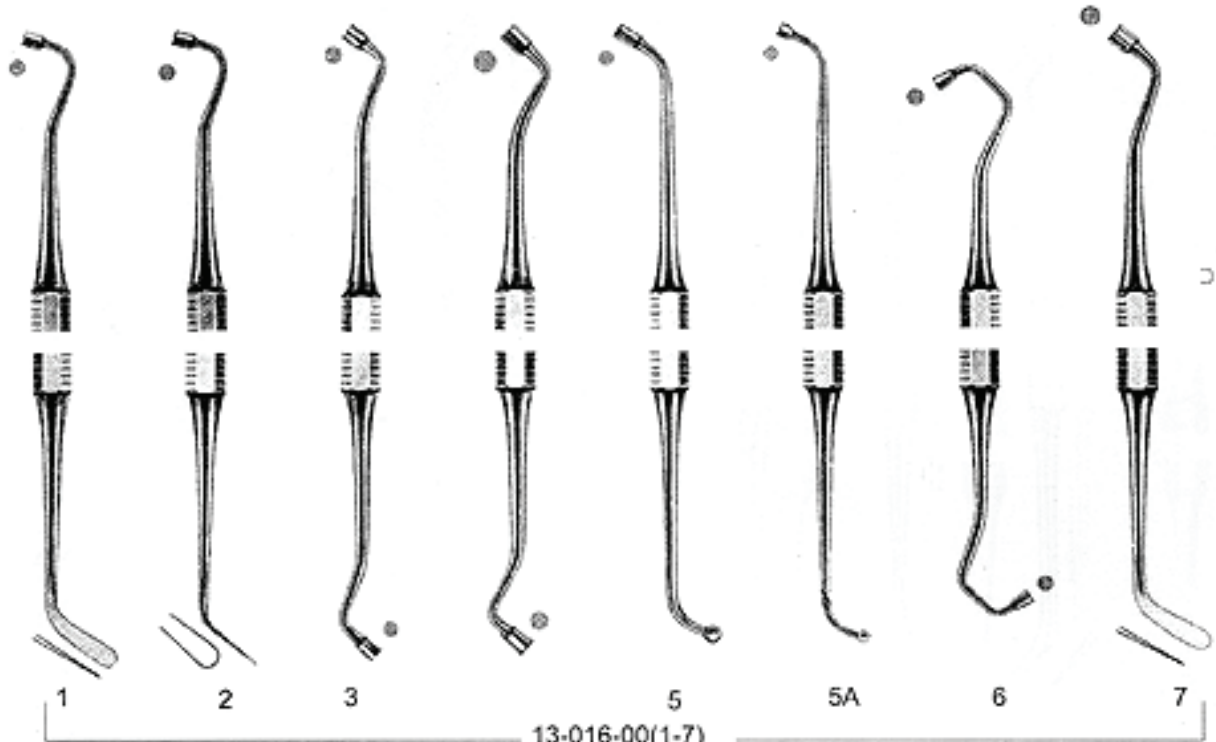
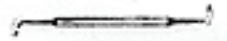

13-016-00(1-7)
Biber

13-016-01 13-016-02 13-016-03 13-016-04 13-016-05 13-016-5A 13-016-06 13-016-07

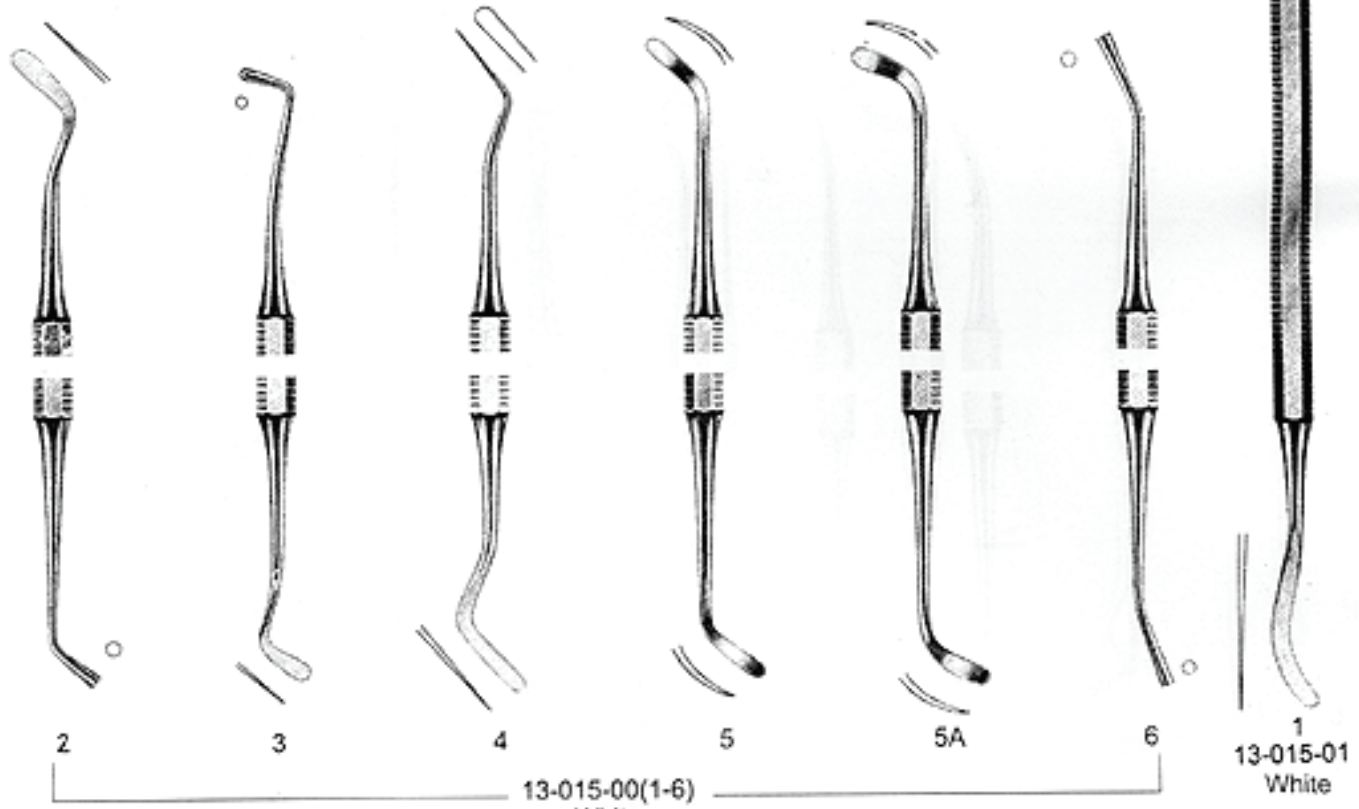

13-015-00(1-6)
White

13-015-02 13-015-03 13-015-04 13-015-05 13-015-05A 13-015-06

13-015-01
White

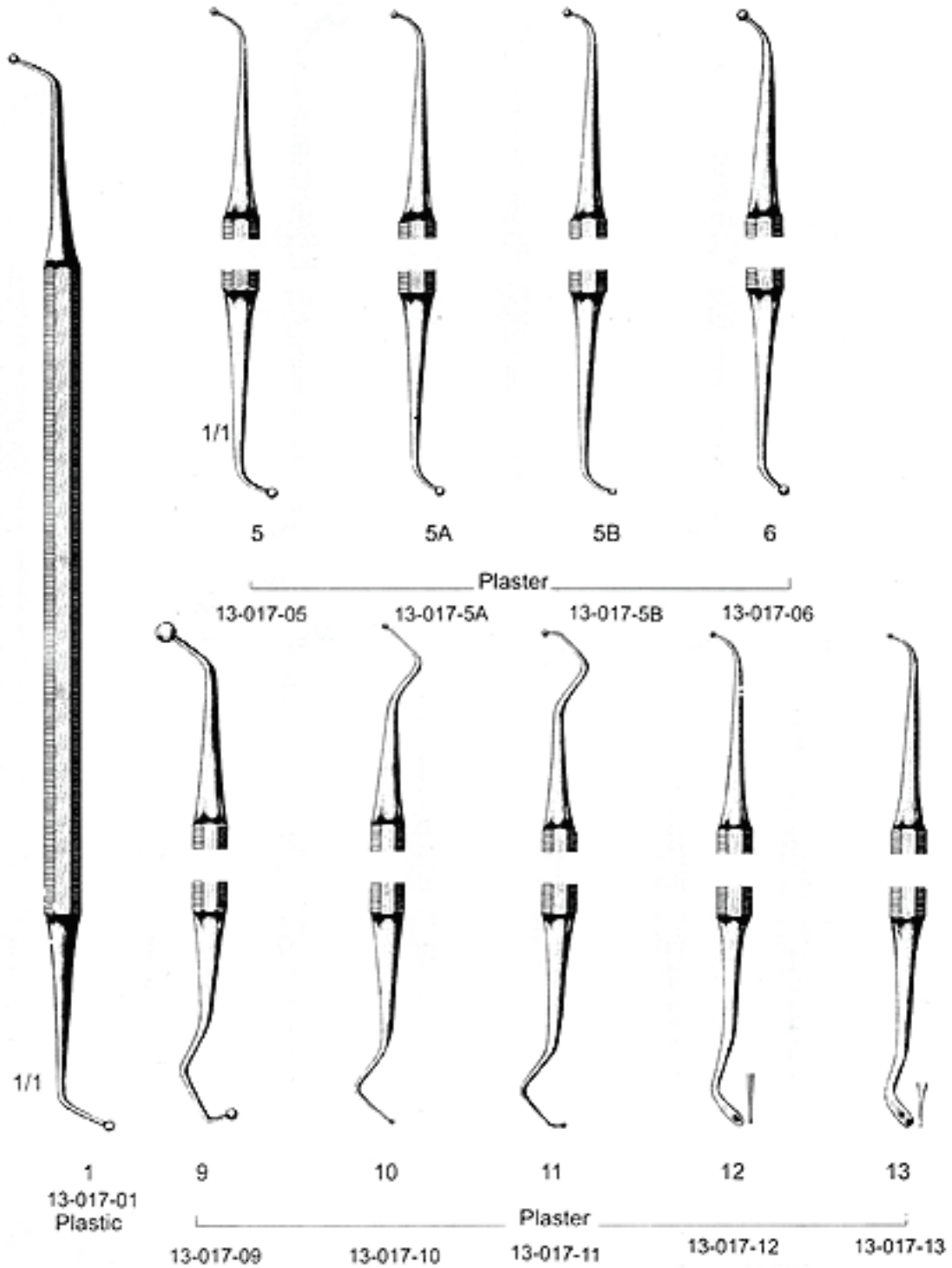

FILLING INSTRUMENTS
INSTRUMENTS POUR PLOMBAGE
INSTRUMENTOS PARA OBTURACIONES

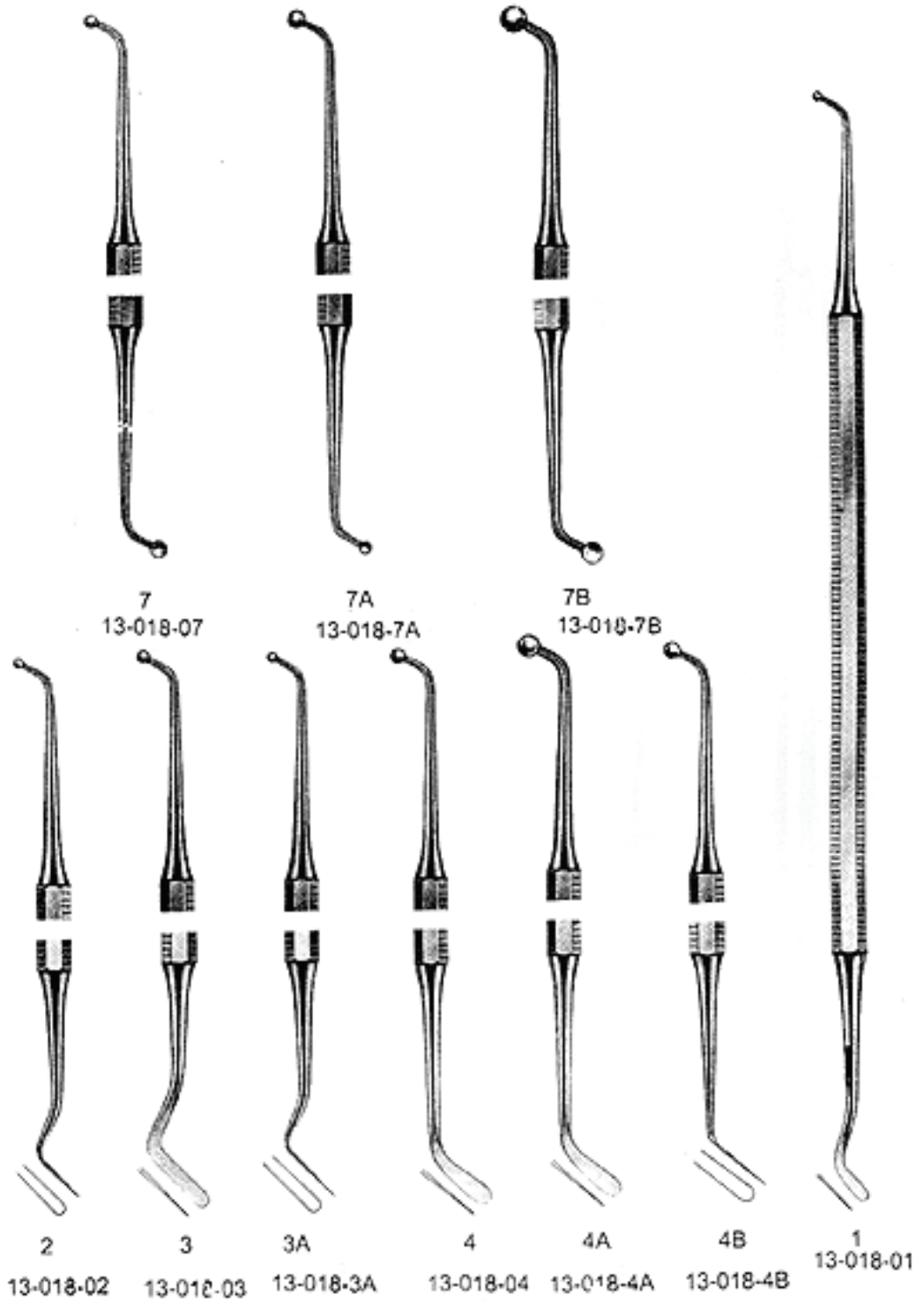



7
 13-018-07
 Plastic

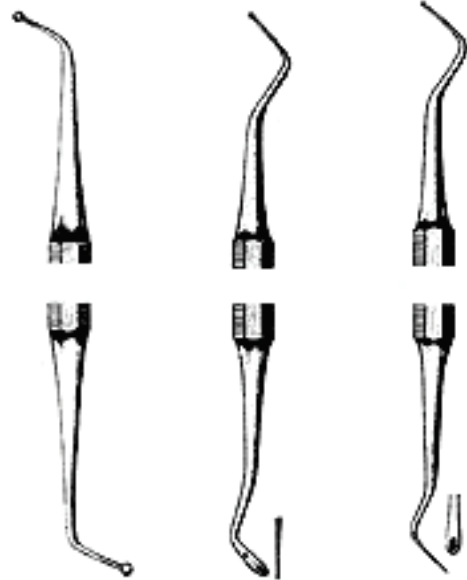

8 14 15

Plastic
 13-018-08 13-018-14 13-018-15

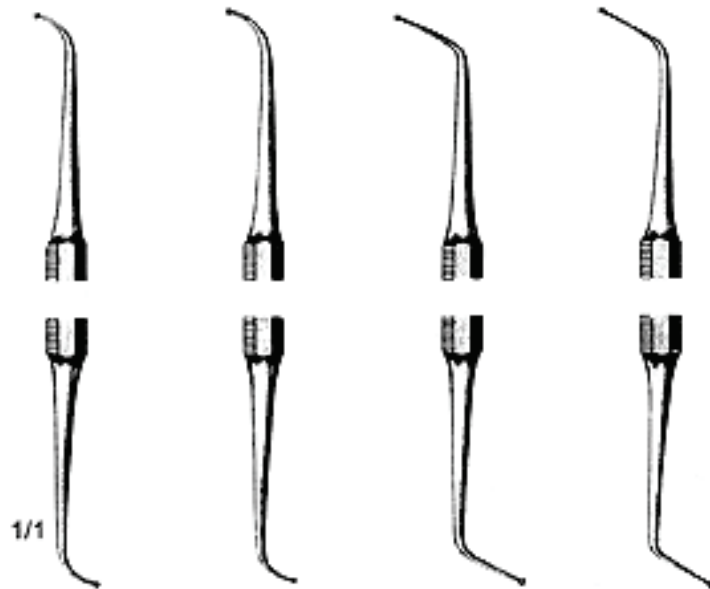

1/1
 16 17 18 19

Plastic
 13-018-16 13-018-17 13-018-18 13-018-19

FILLING INSTRUMENTS
INSTRUMENTS POUR PLOMBAGE
INSTRUMENTOS PARA OBTURACIONES



15
13-019-15

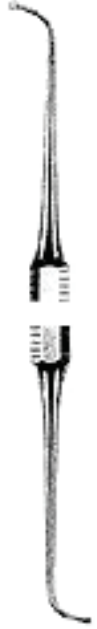

16
13-019-16



17
13-019-17



18
13-019-18

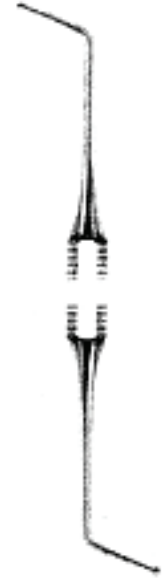

19
13-019-19



8
13-019-08



9
13-019-09



10
13-019-10

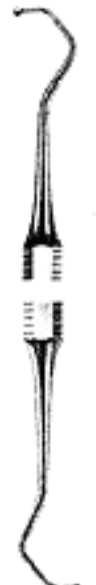

11
13-019-11

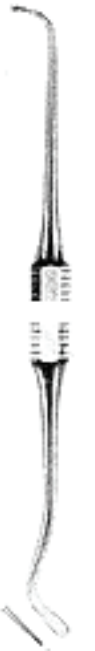

12
13-019-12

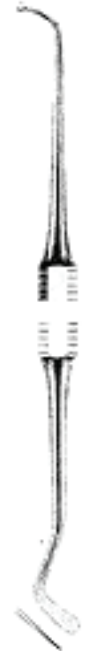

13
13-019-13

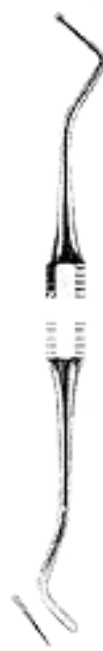

14
13-019-14

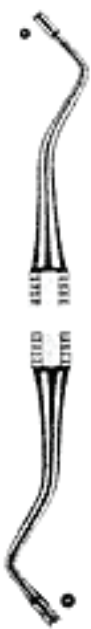

44
13-020-44

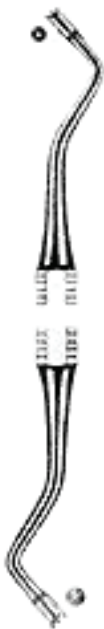

45
13-020-45

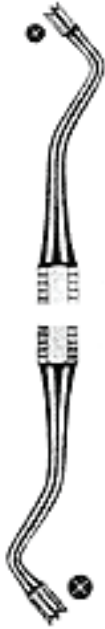

46
13-020-46

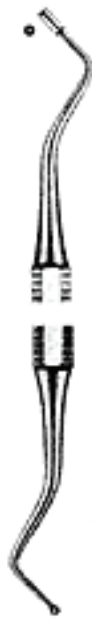

47
13-020-47



48
13-020-48



49
13-020-49



50
13-020-50



36
13-020-36



37
13-020-37



38
13-020-38



39
13-020-39



40
13-020-40



41
13-020-41



42
13-020-42



43
13-020-43



35
13-020-35

FILLING INSTRUMENTS
INSTRUMENTS POUR PLOMBAGE
INSTRUMENTOS PARA OBTURACIONES

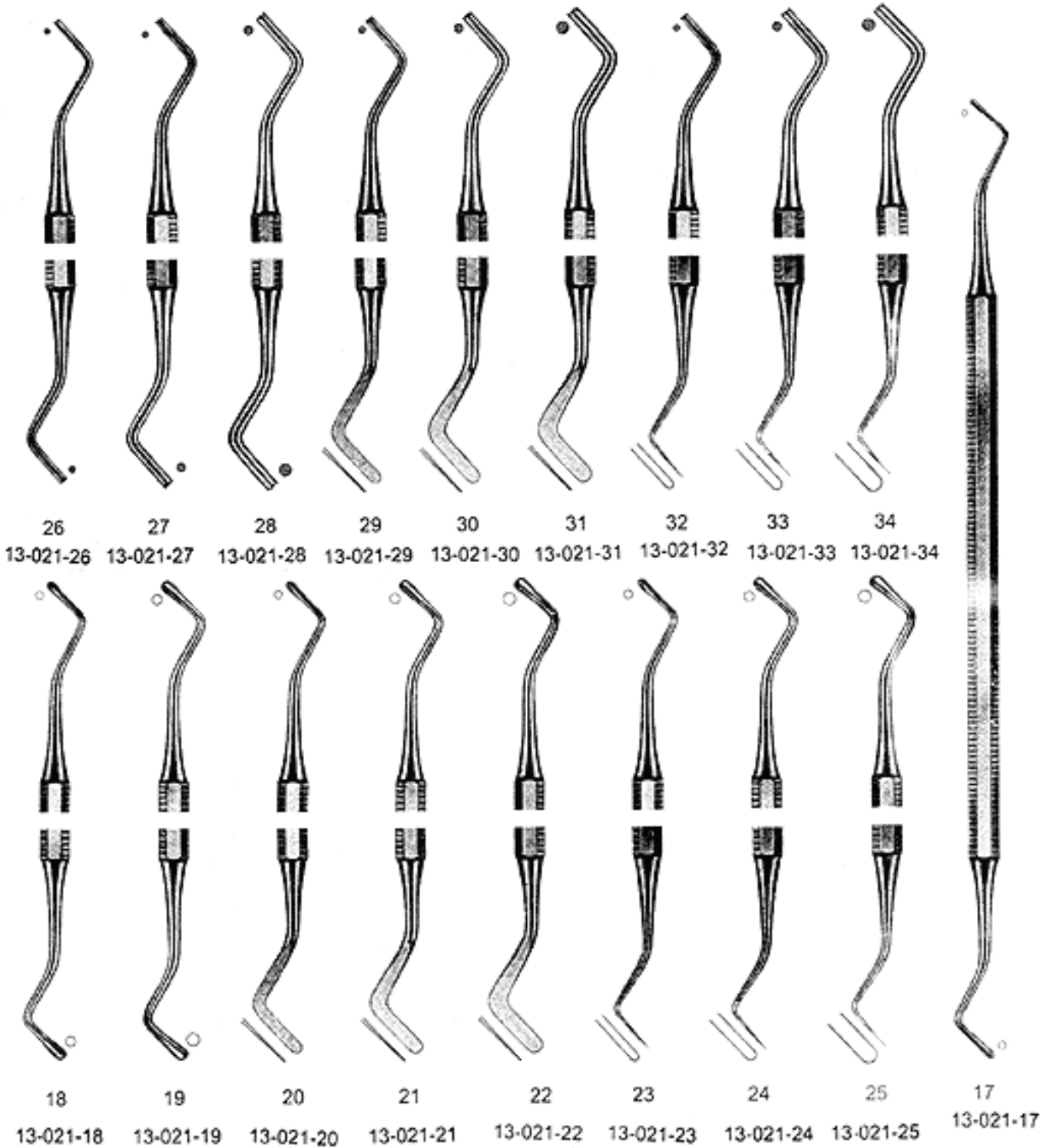

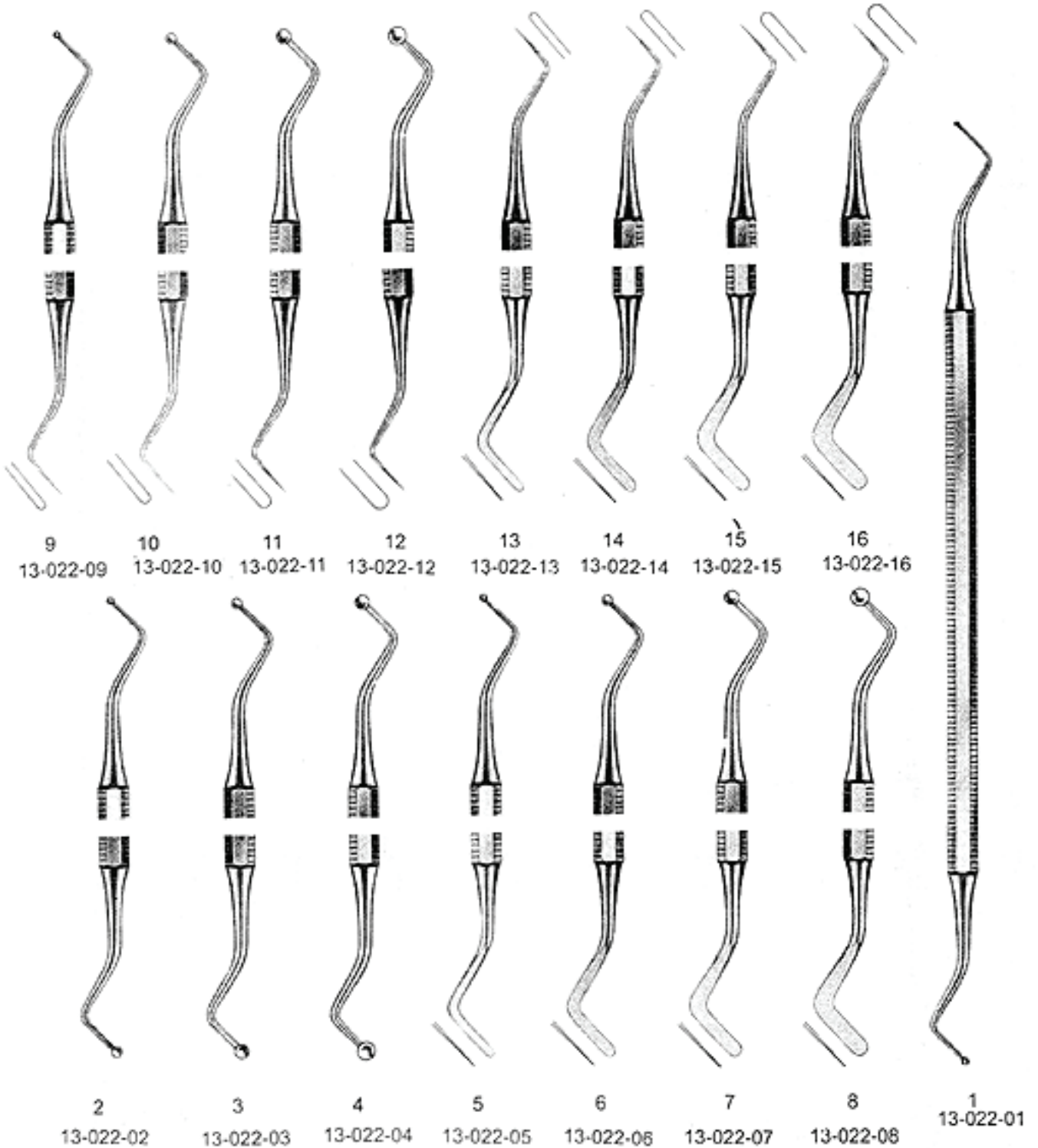

FILLING INSTRUMENTS
 INSTRUMENTS POUR PLOMBAGE
 INSTRUMENTOS PARA OBTURACIONES

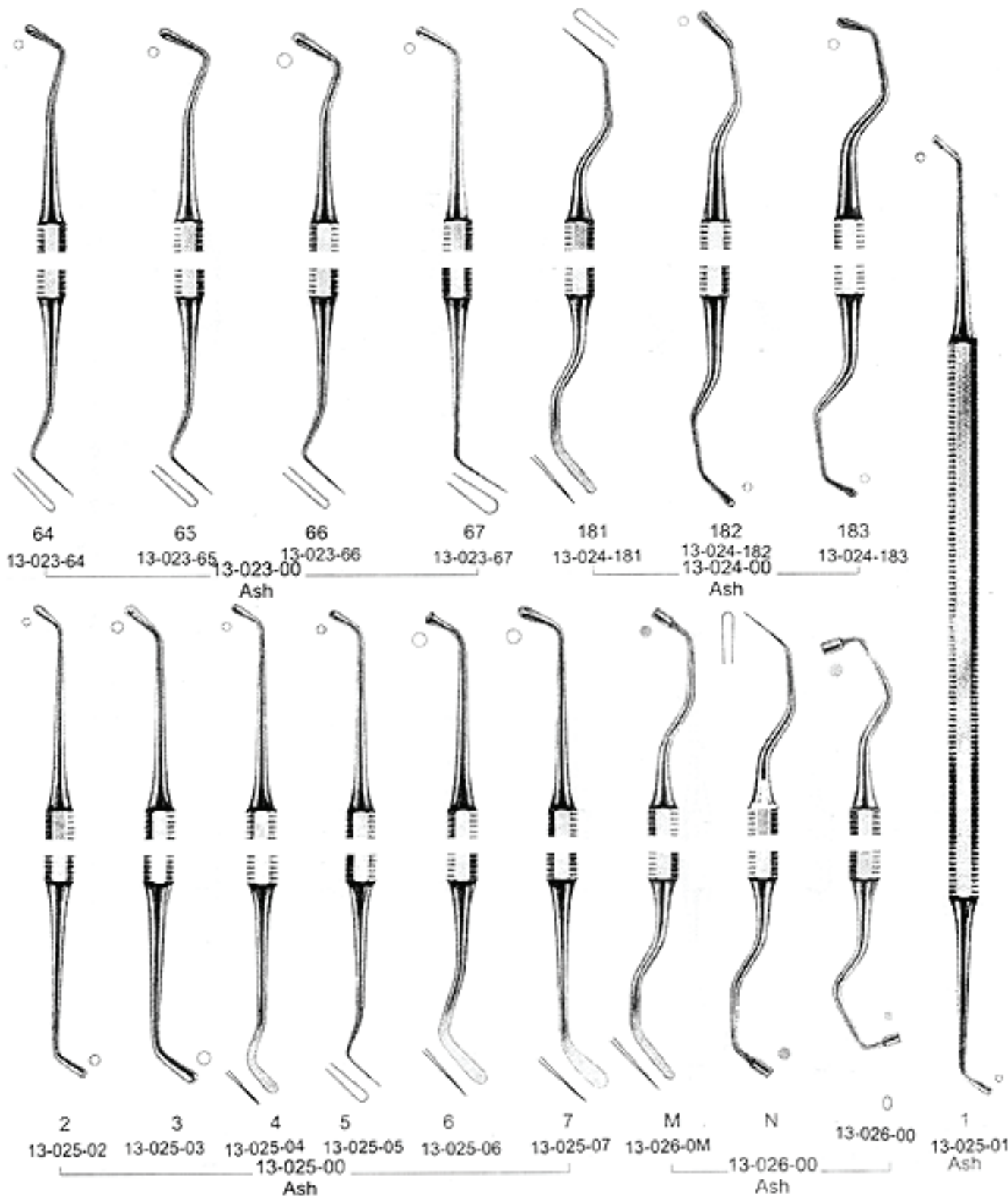

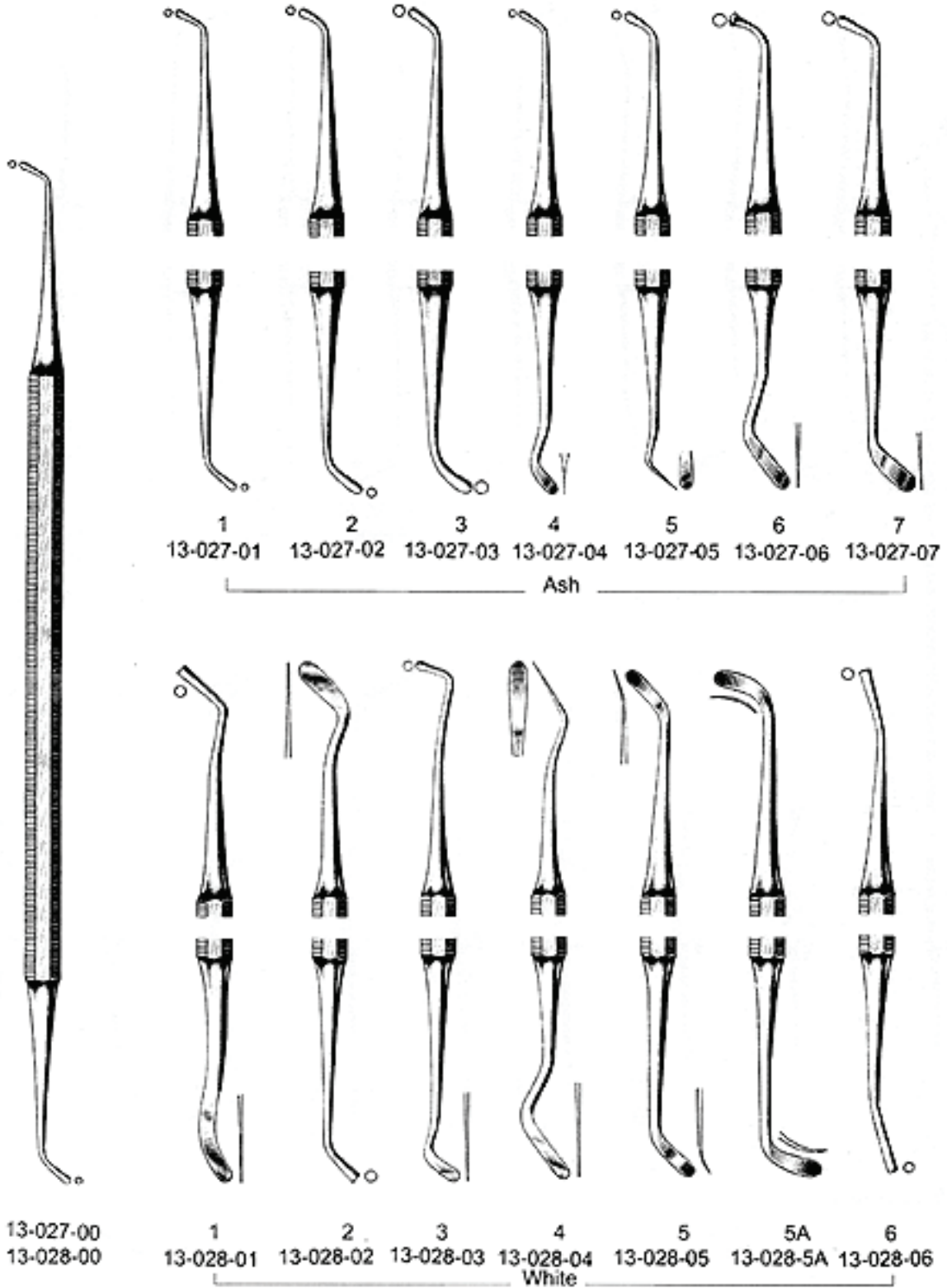

FILLING INSTRUMENTS
 INSTRUMENTS POUR PLOMBAGE
 INSTRUMENTOS PARA OBTURACIONES

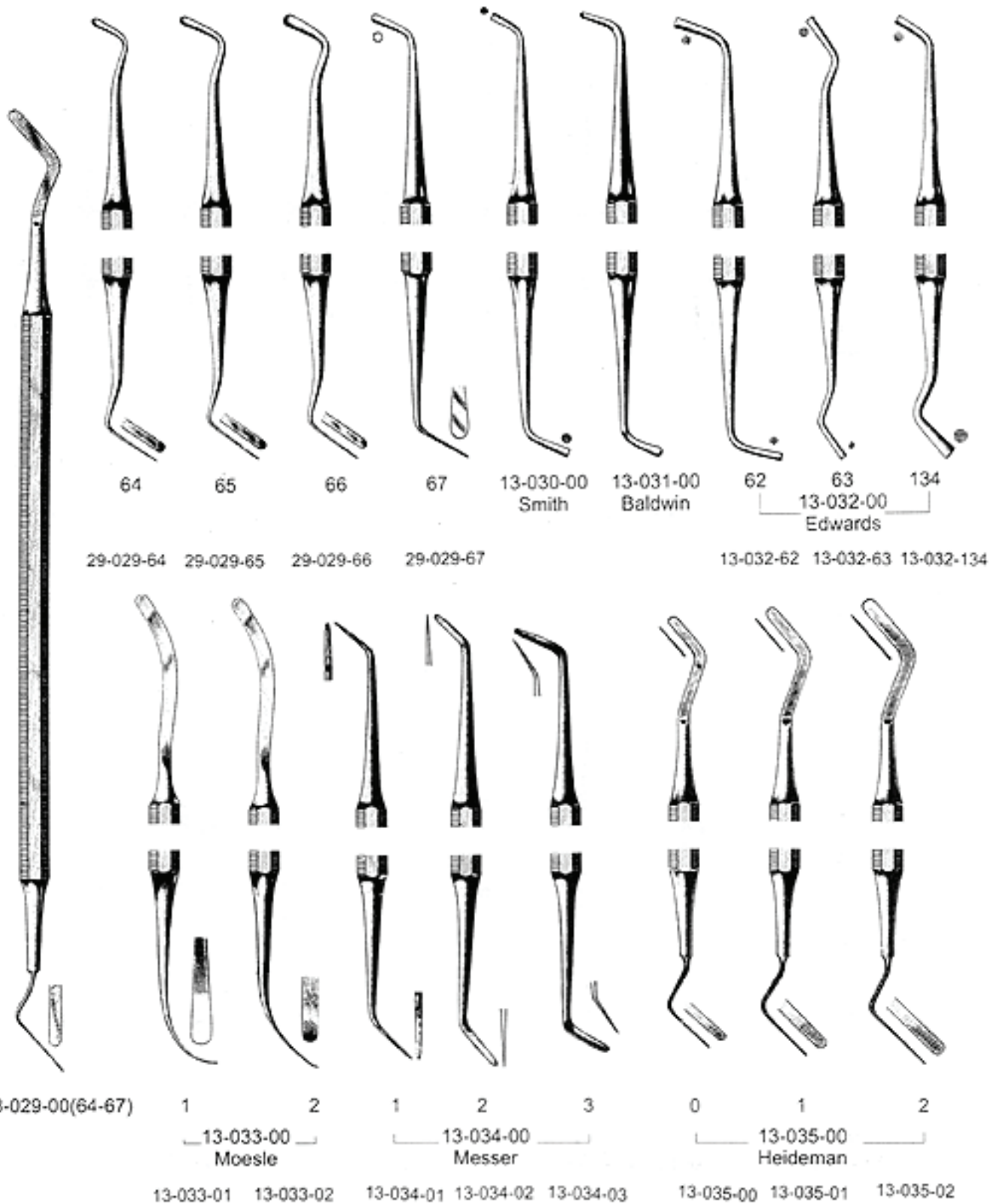

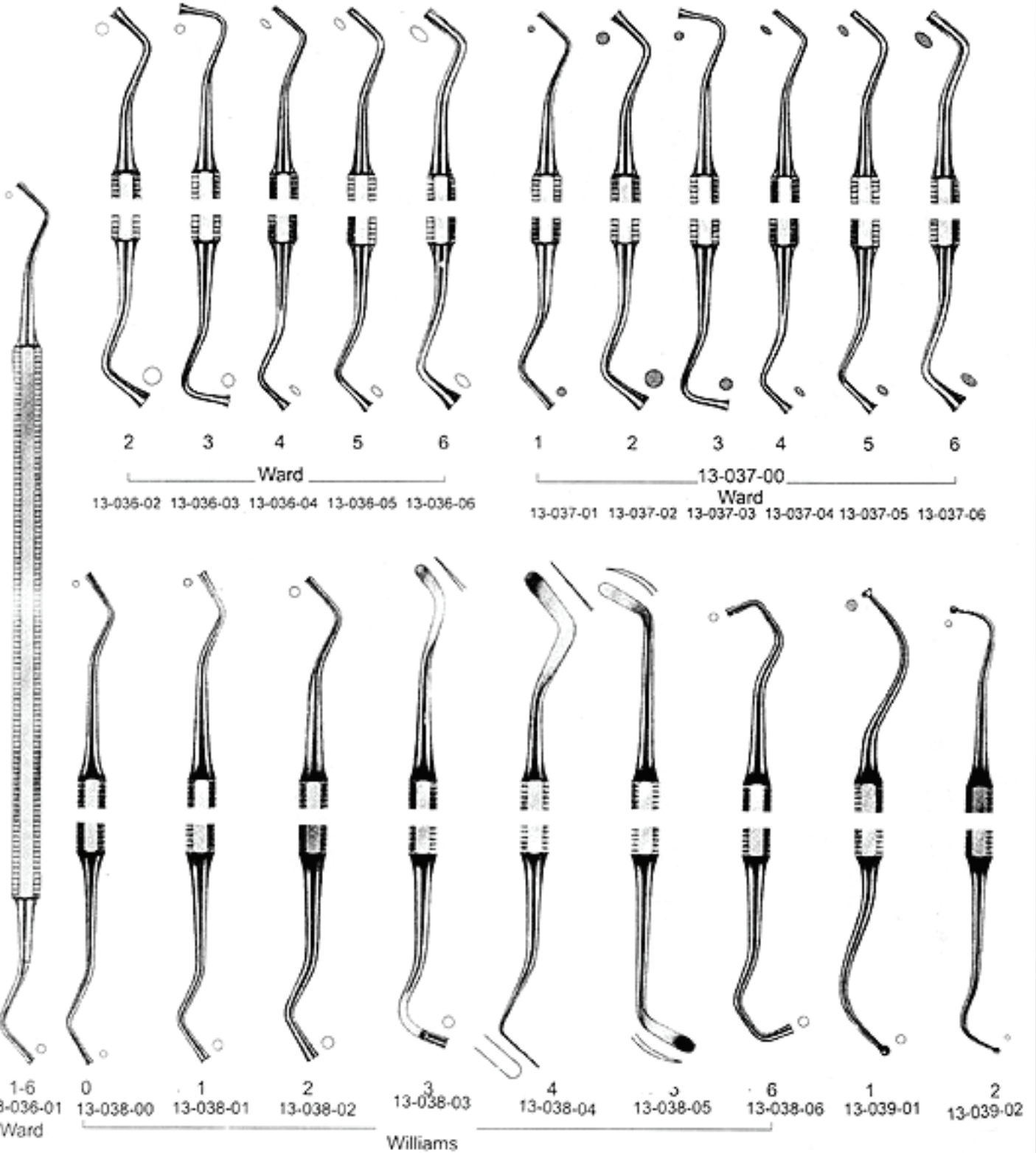

FILLING INSTRUMENTS
INSTRUMENTS POUR PLOMBAGE
INSTRUMENTOS PARA OBTURACIONES

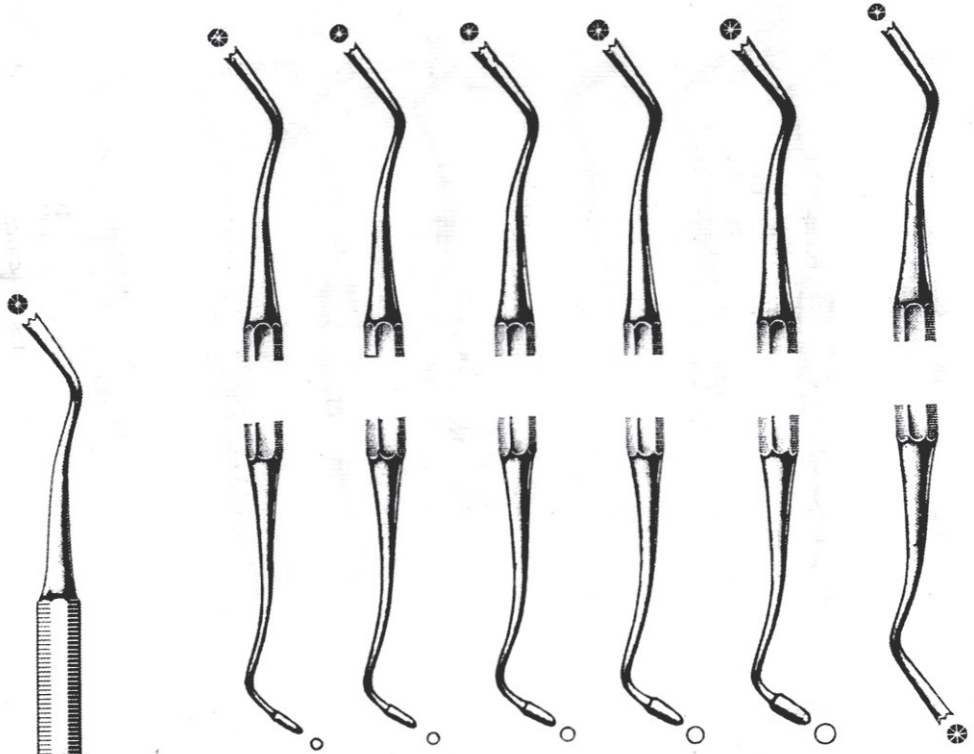
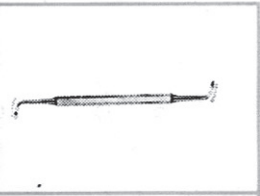

189 190 191 192 193 194
13-040-189 13-040-190 13-040-191 13-040-192 13-040-193 13-040-194

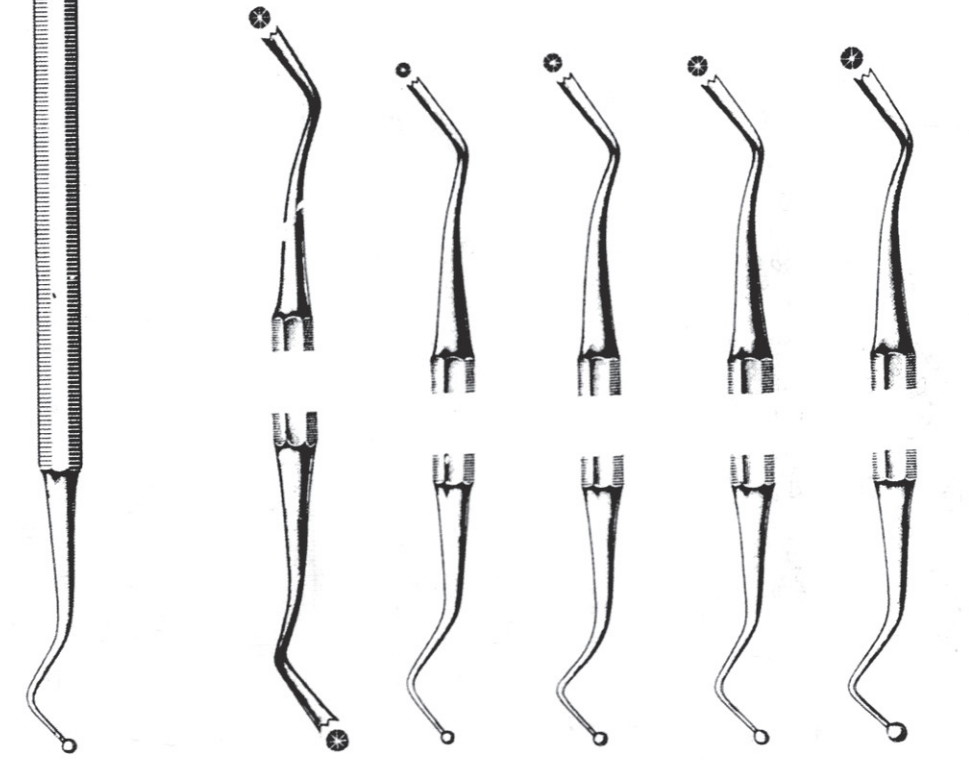

189-199
13-040-00 195 196 197 198 199
13-040-195 13-040-196 13-040-197 13-040-198 13-040-199

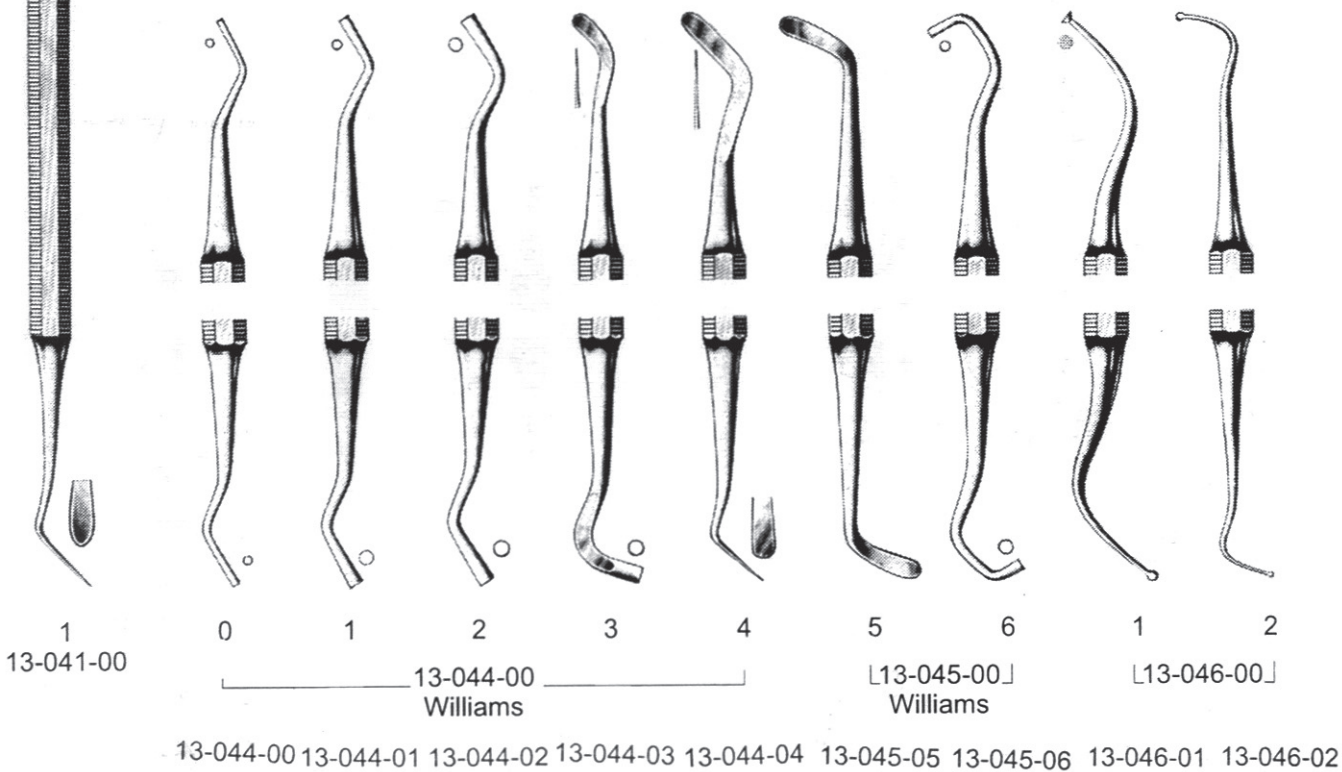
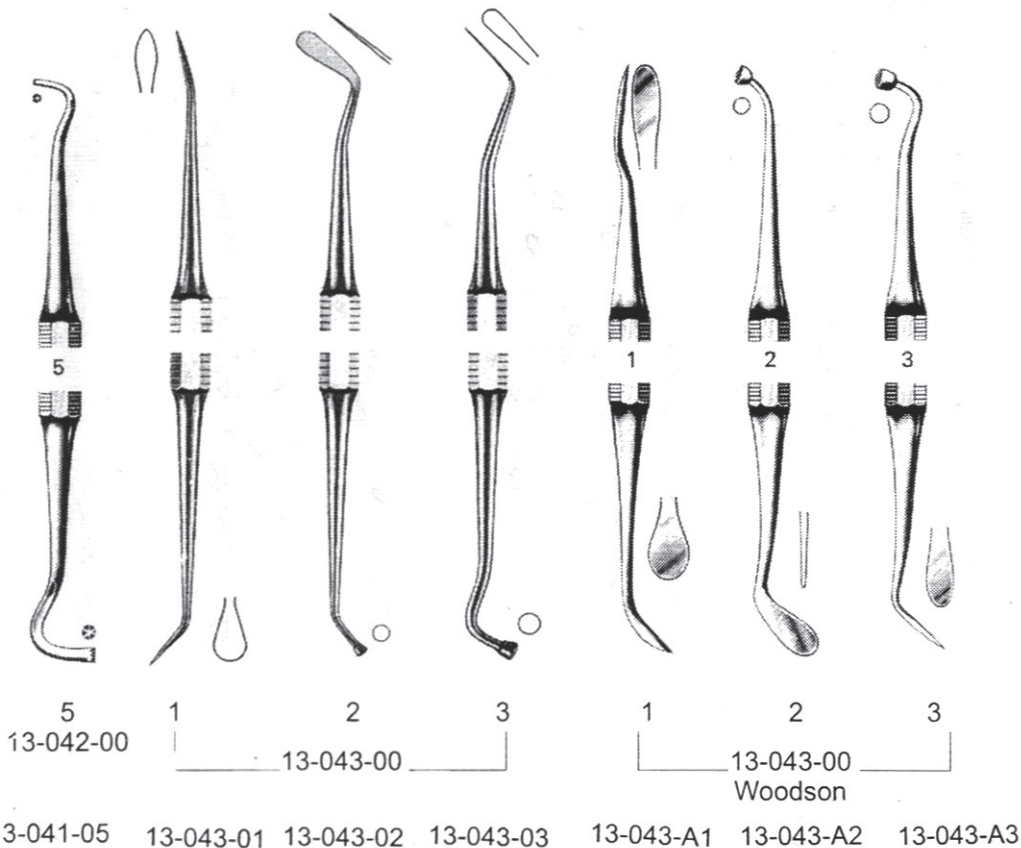
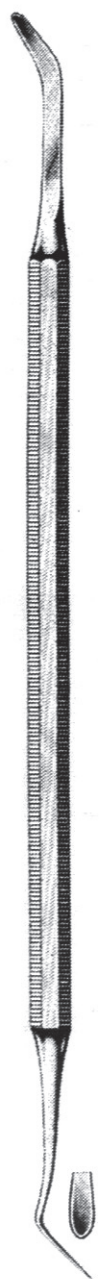

FILLING INSTRUMENTS
INSTRUMENTS POUR PLOMBAGE
INSTRUMENTOS PARA OBTURACIONES

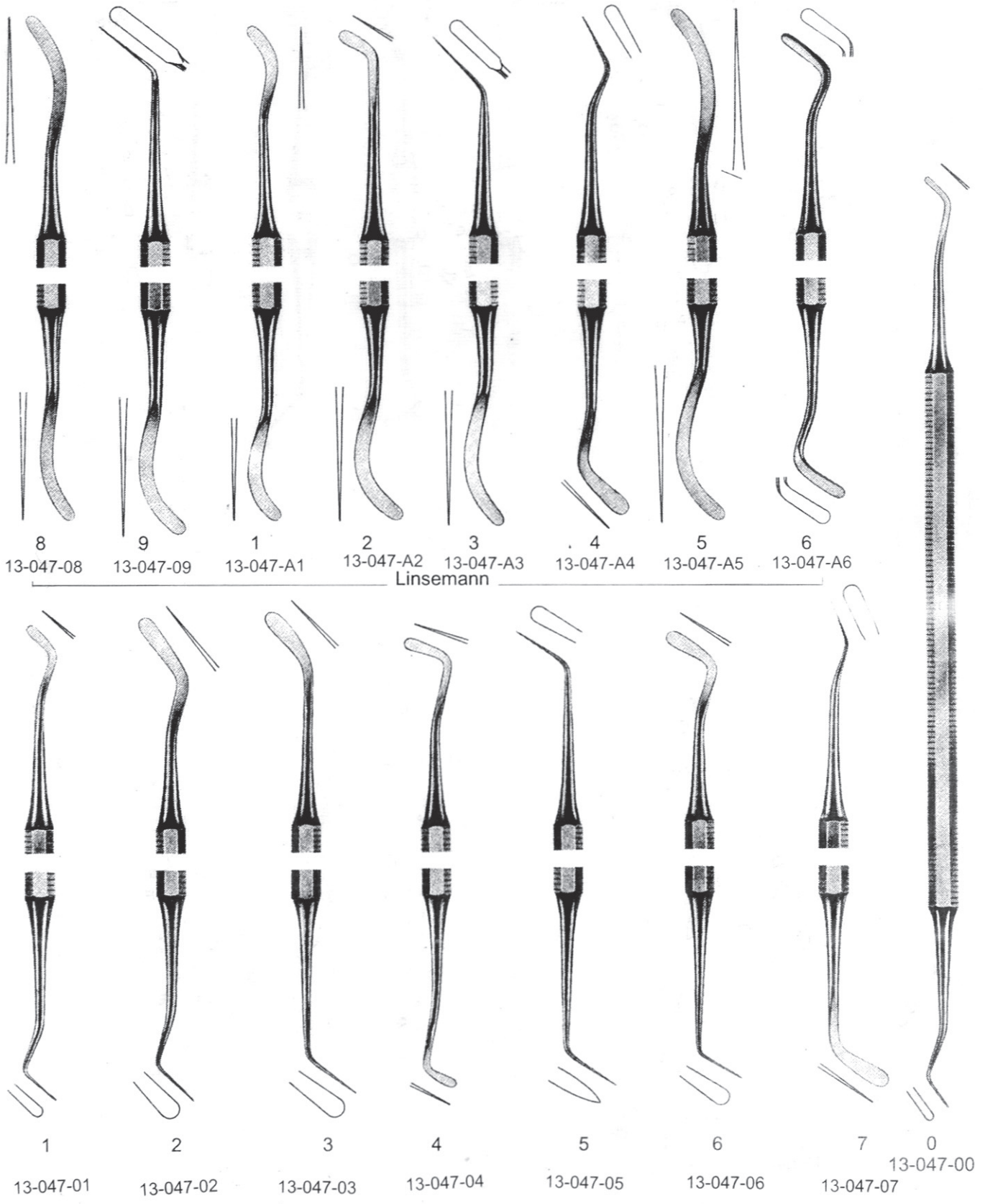
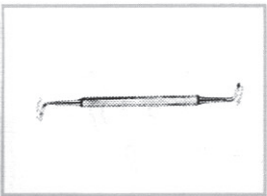

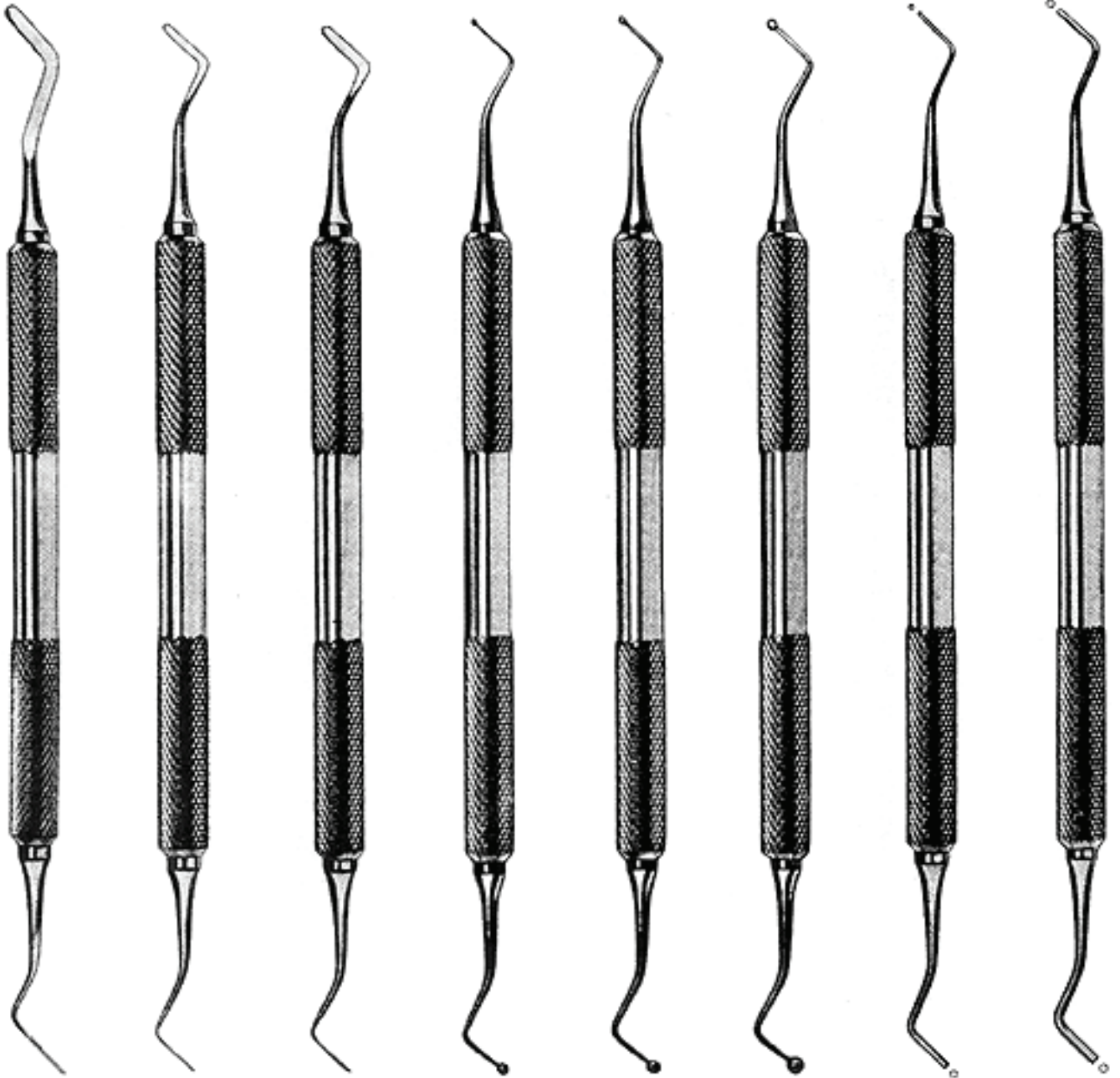

42
13-048-00
Hidemann

11
13-049-00

12
13-050-00

2
13-051-00

4
13-052-00

6
13-053-00

20
13-054-00

21
13-055-00

FILLING INSTRUMENTS
 INSTRUMENTS POUR PLOMBAGE
 INSTRUMENTOS PARA OBTURACIONES

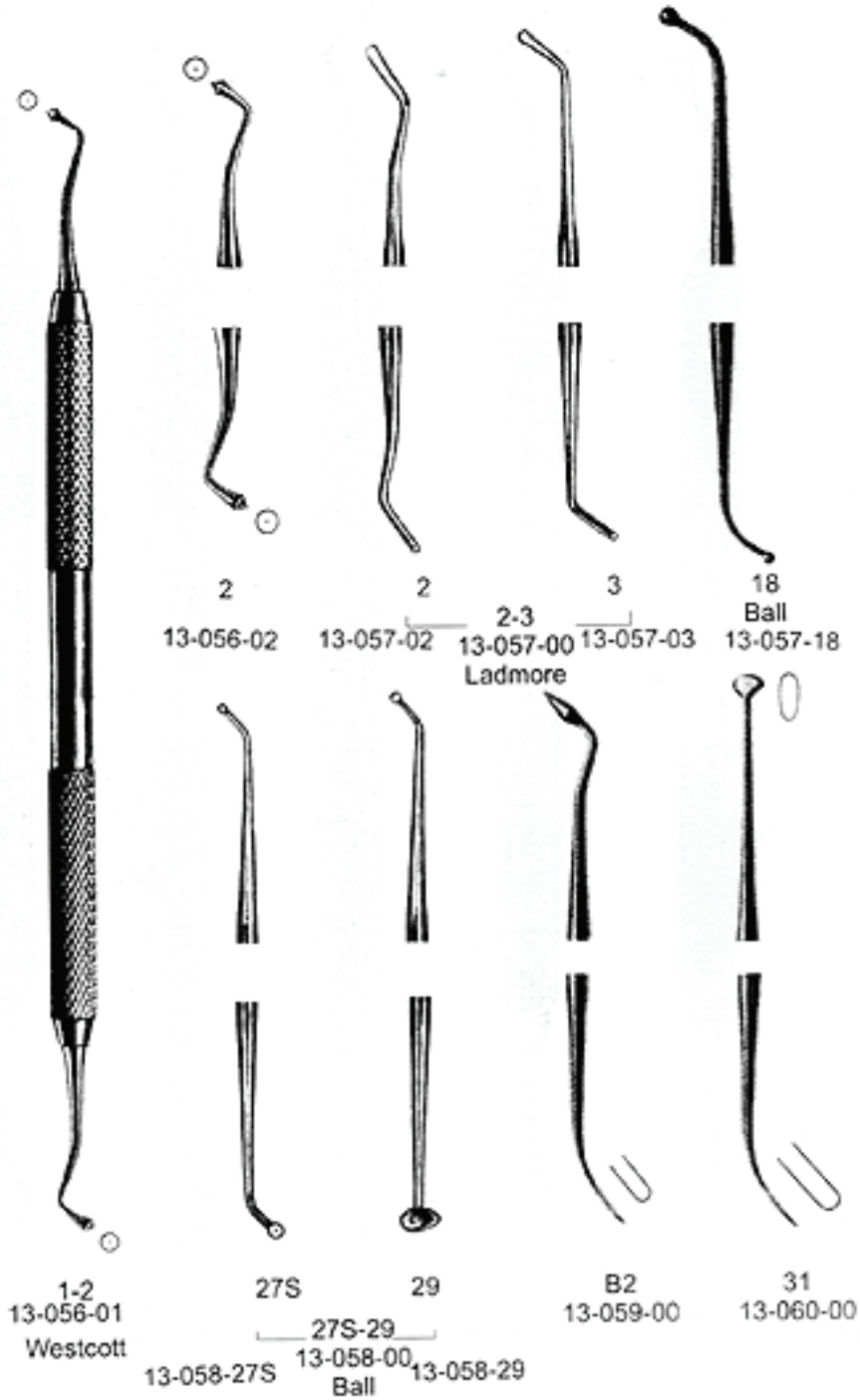

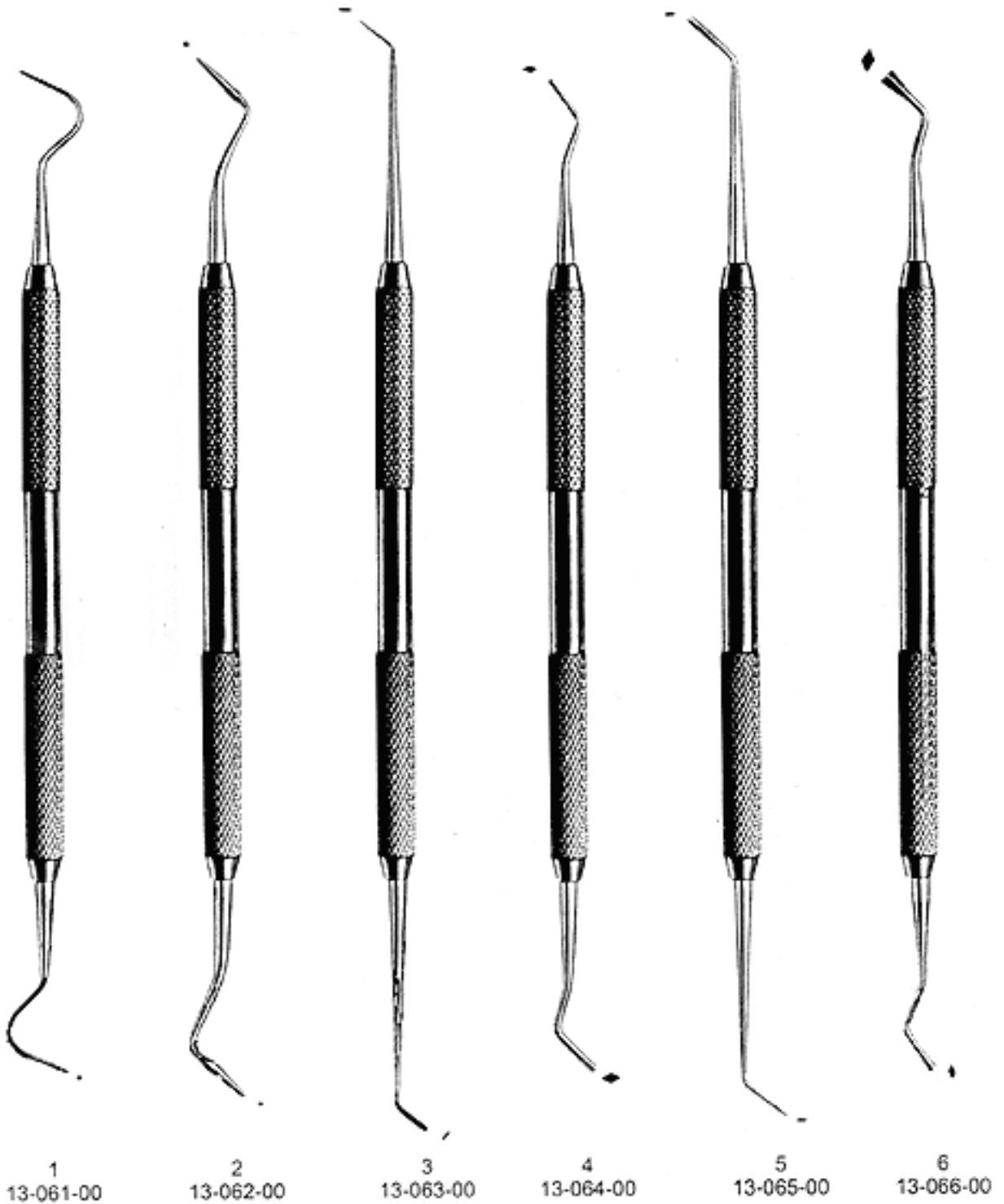

FILLING INSTRUMENTS
 INSTRUMENTS POUR PLOMBAGE
 INSTRUMENTOS PARA OBTURACIONES

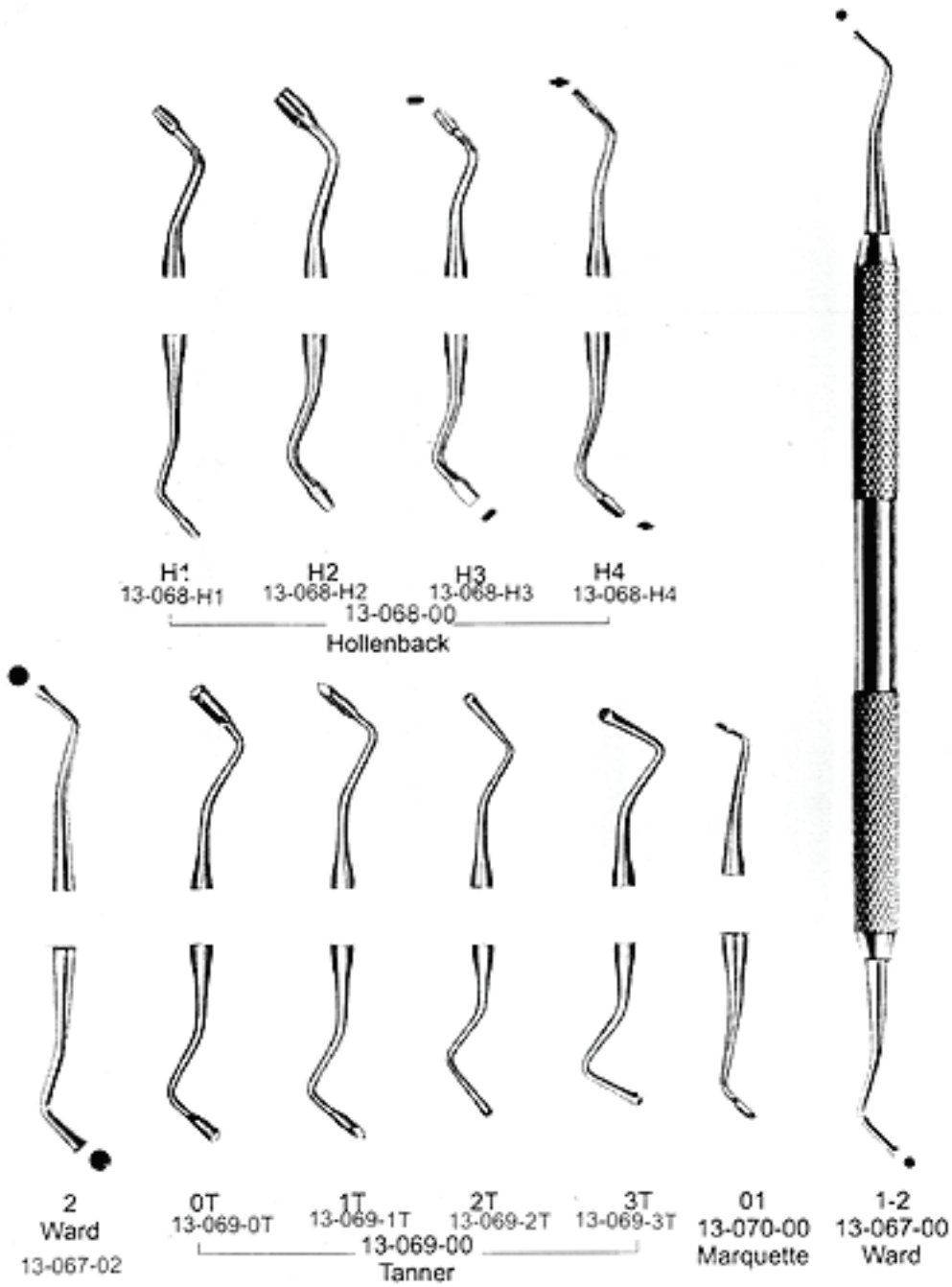

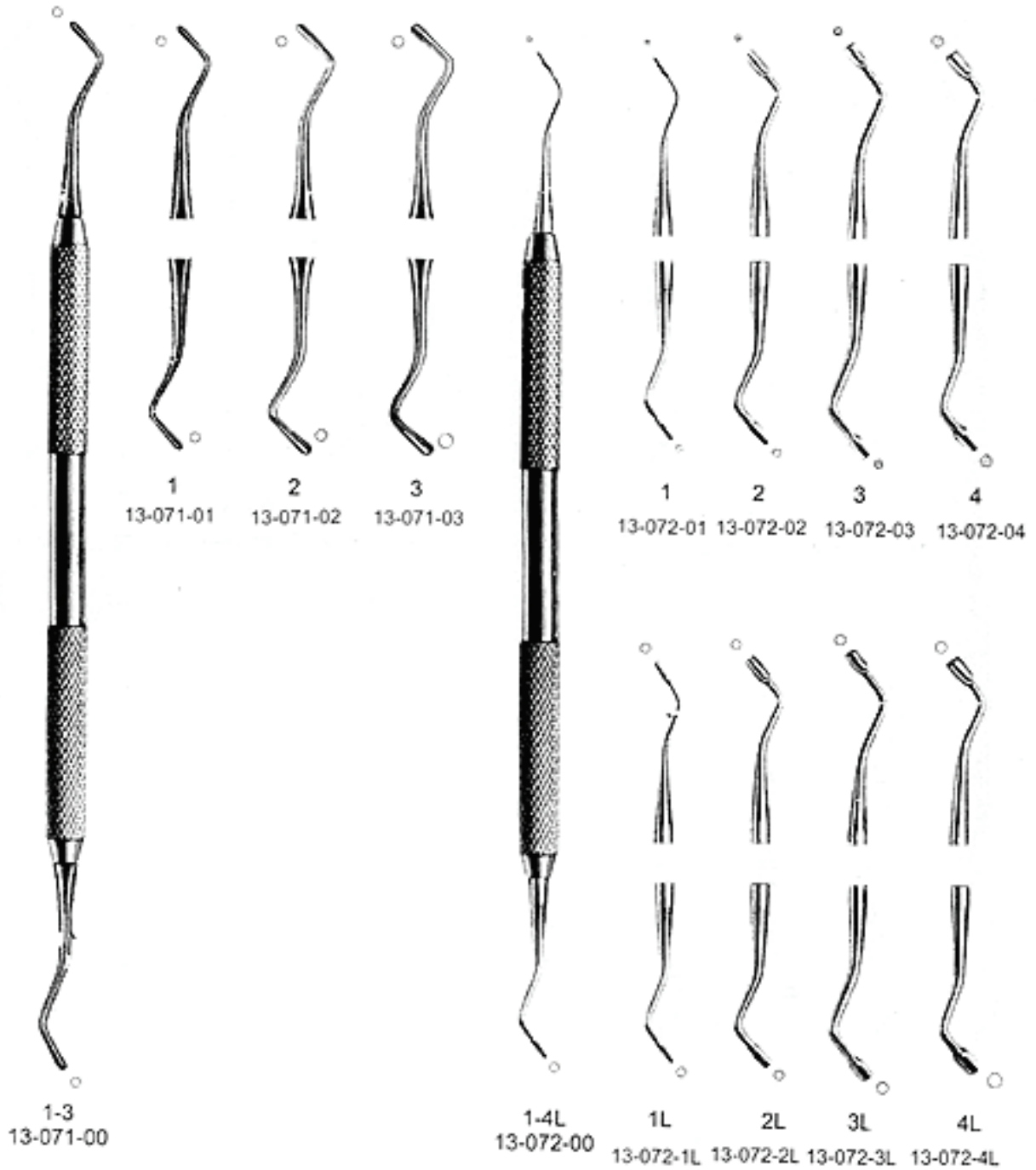

FILLING INSTRUMENTS
INSTRUMENTS POUR PLOMBAGE
INSTRUMENTOS PARA OBTURACIONES

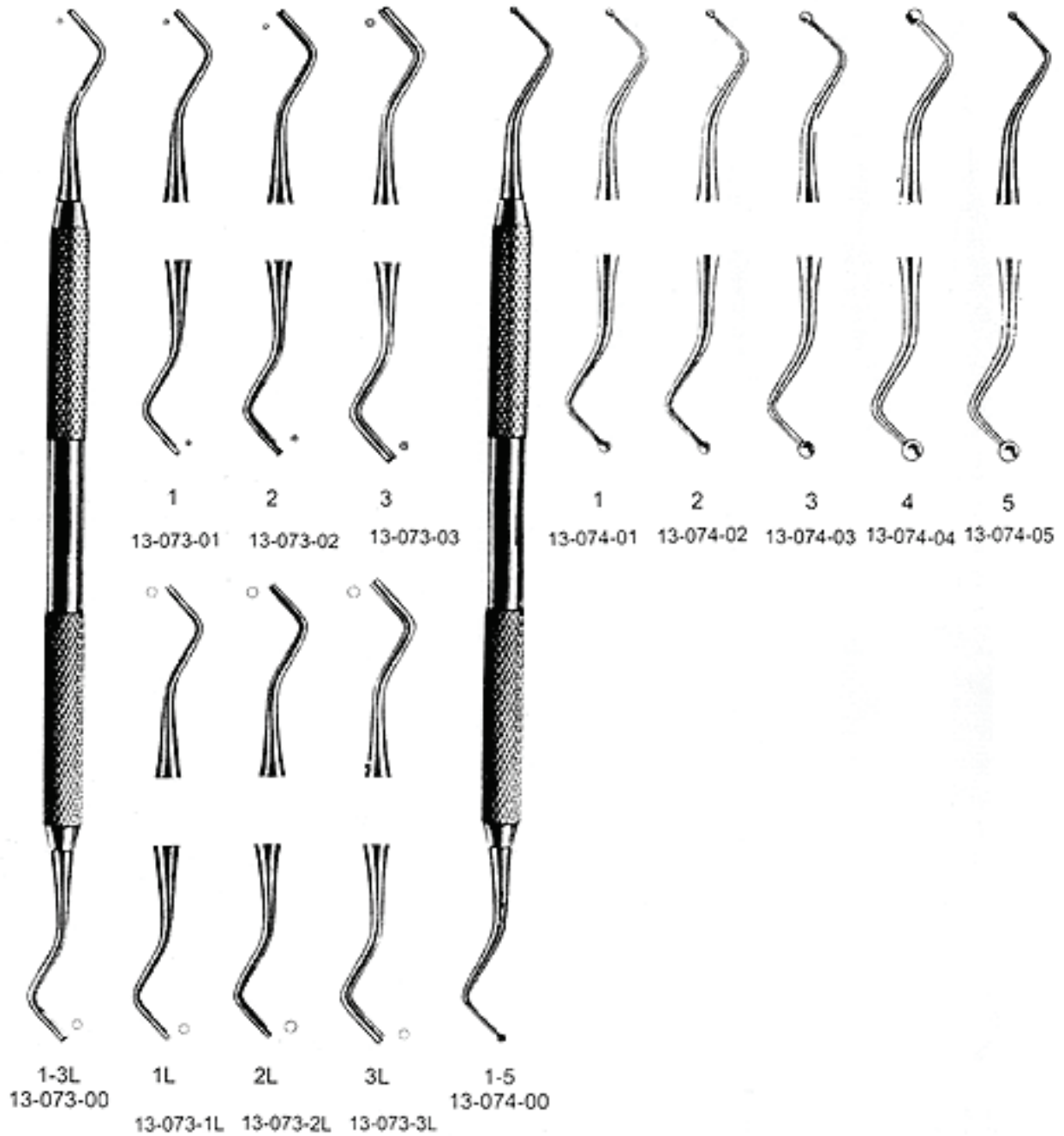



1
13-075-00

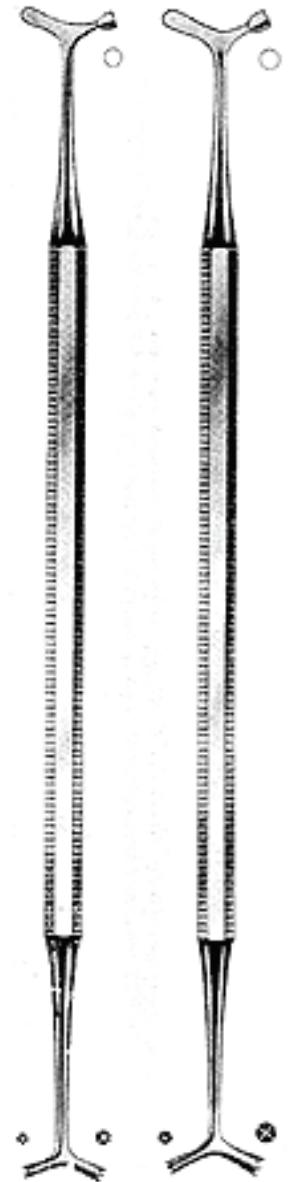
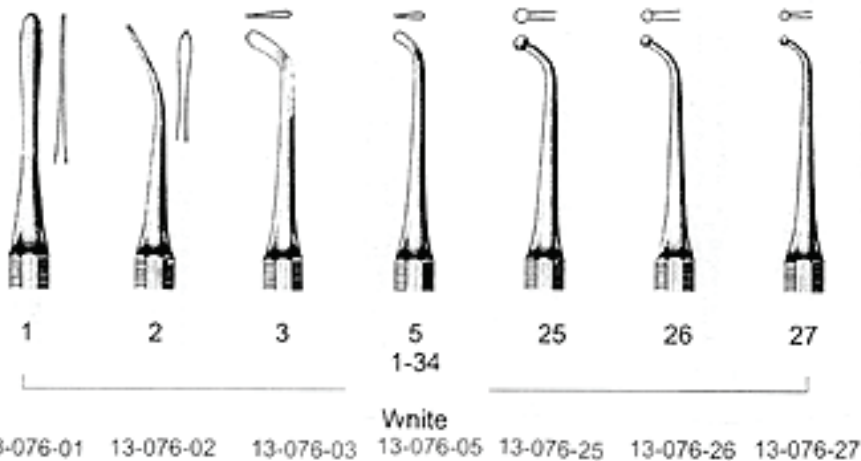
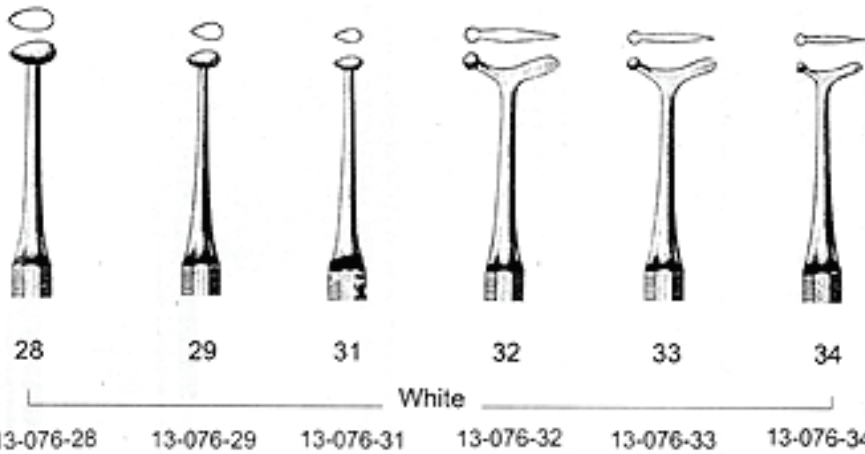

1
13-077-00

1
13-078-00

FILLING INSTRUMENTS
 INSTRUMENTS POUR PLOMBAGE
 INSTRUMENTOS PARA OBTURACIONES



1
13-079-01



28/29
13-079-00



27/29
13-080-00

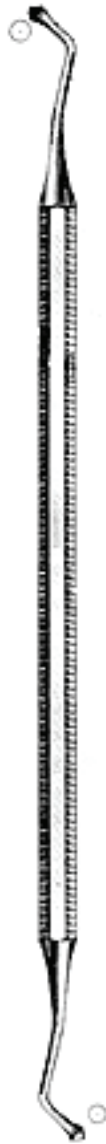

21B
13-081-00

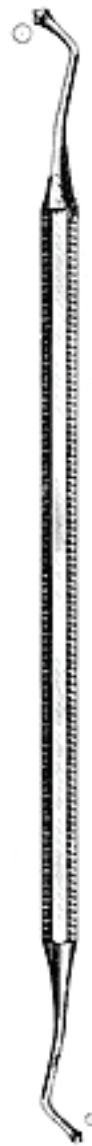

21
13-082-00



Discoide
89/92
13-083-00



13-084-00



Cleoid-Discoid
89/90
13-099-00

Excavator
17
13-100-00

Filling
Instrument
13-101-00

Filling
Instrument
13-102-00

Amalgam
Condenser
13-103-00

NOTE: All other hand instruments are also available in Silicon Grip Handle

Department

14

BONE RONGEUR FORCEPS
HOHLMEISSELZANGEN
PINZAS GUBIAS

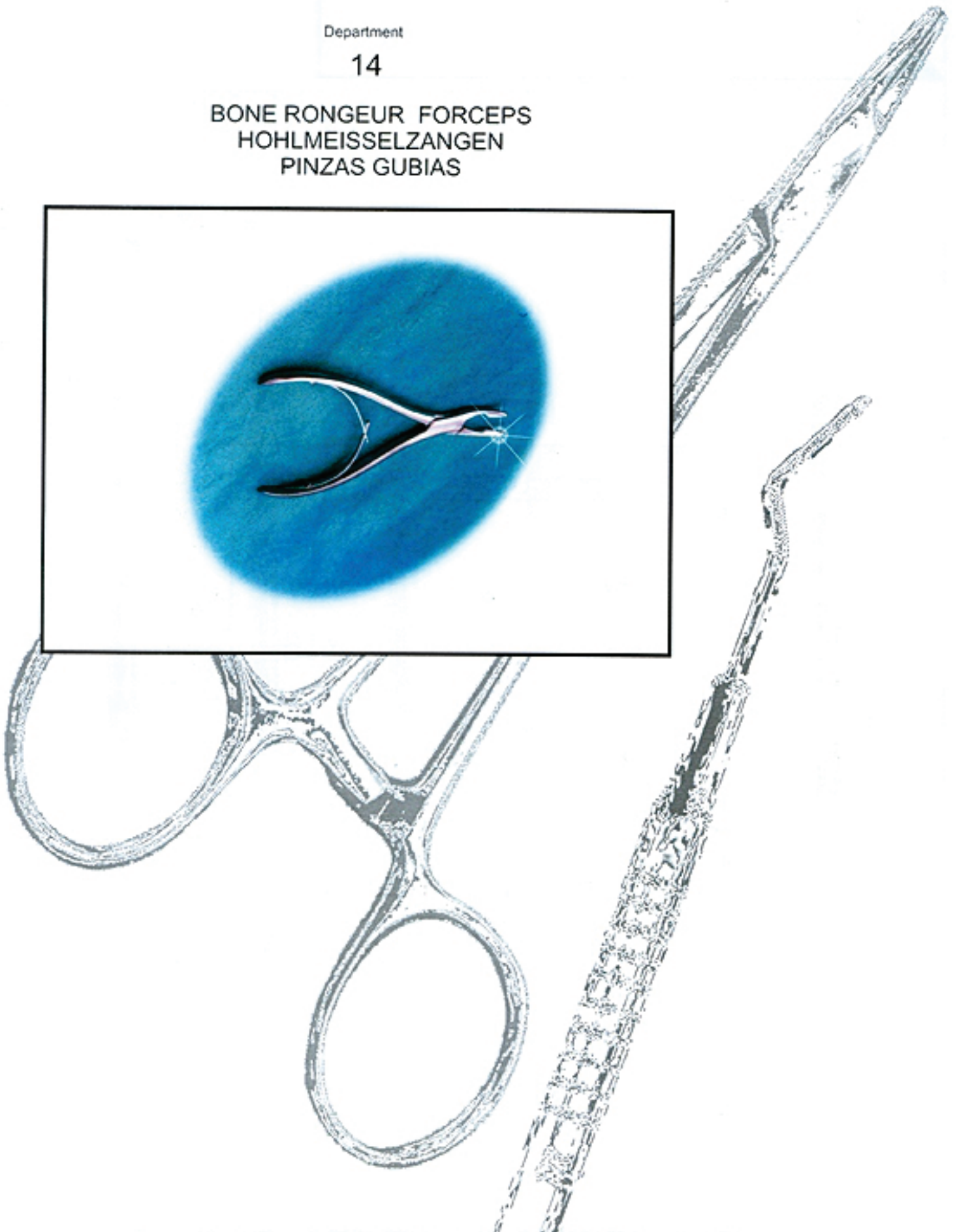
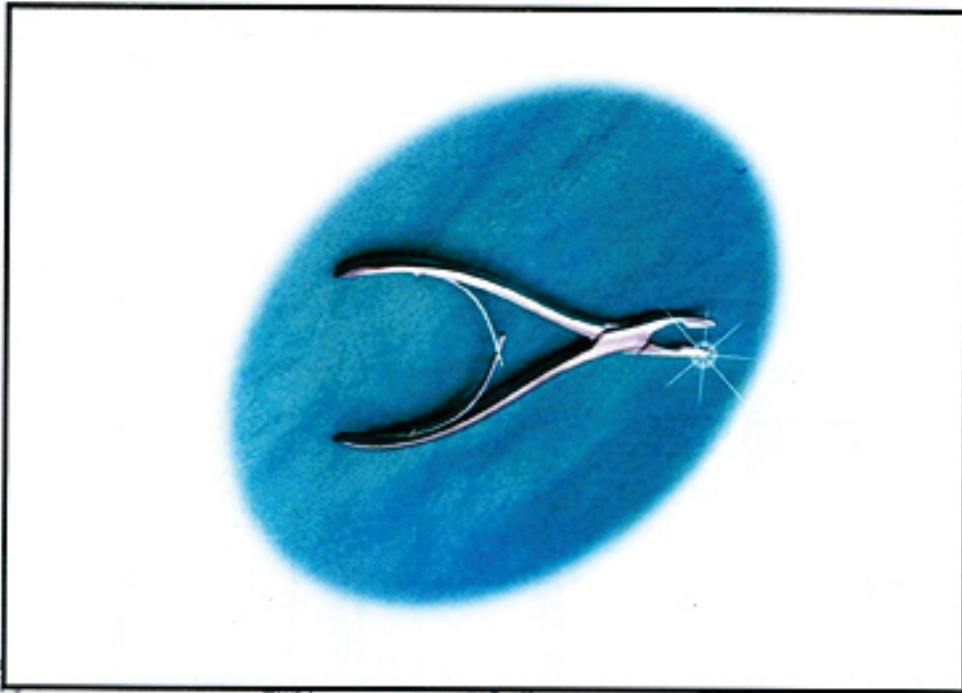

DEPARTMENT NO. 14

FROM
PAGE#

207

TO
PAGE#

216

INSTRUMENTS CATEGORY

BONE RONGEUR FORCEPS
HOHLMEISSELZANGEN
PINZAS GUBIAS



14-001-17
 17. Cm
 Cleveland



14-002-14
 14. Cm
 Friedman



14-003-14
 14. Cm
 Cleveland



14-004-12
 12. Cm
 Mini-Friedman



14-005-18
 18.5 Cm
 Hartmann



14-006-16
 16.5 Cm



14-007-16
 16.5 Cm

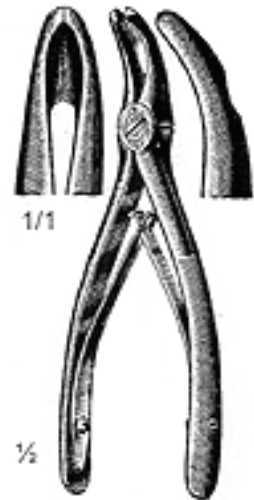

14-008-13
 13.5 Cm
 Universal

— Mead —

BONE RONGEUR FORCEPS
HOHLMEISSELZANGEN
PINZAS GUBIAS



14-009-15
15. Cm
Luer



1/2
14-010-18
18. Cm



14-011-15
15.5 Cm
Blumenthal

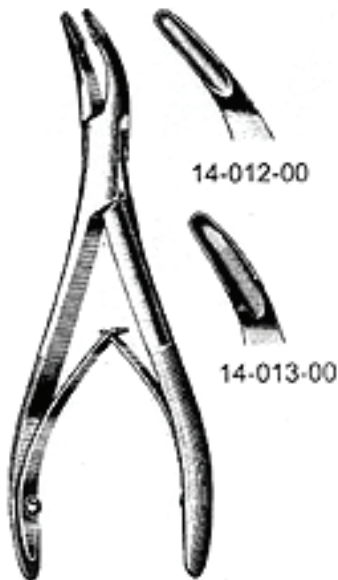

14-012-15
15. Cm
Luer



14-012-00

14-013-00



1/2
14-014-15
15.5 Cm



14-015-15
15.5 Cm

Blumenthal



14-016-16
 16cm
 Cleveland-Gardener



14-018-17
 17cm
 Cleveland



14-019-15
 15cm
 Cleveland



14-020-15
 15cm



14-021-18
 18cm
 Beyer

BONE RONGEUR FORCEPS
HOHLMEISSELZANGEN
PINZAS GUBIAS

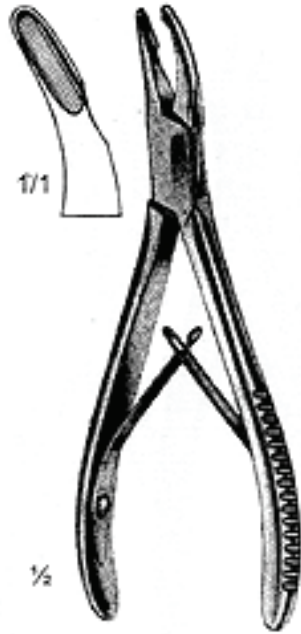

14-072-17
17cm

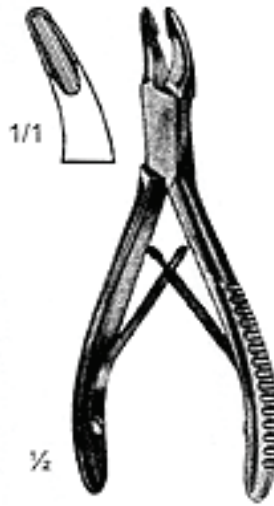

14-073-14
14cm

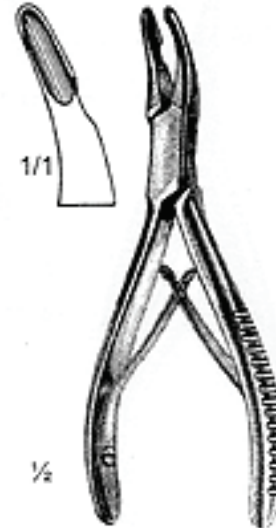

14-074-15
15cm

Cleveland

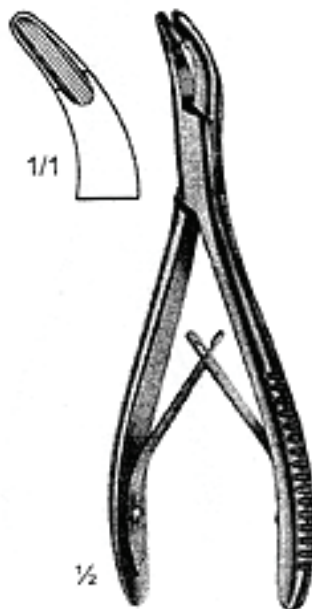

14-075-17
17cm

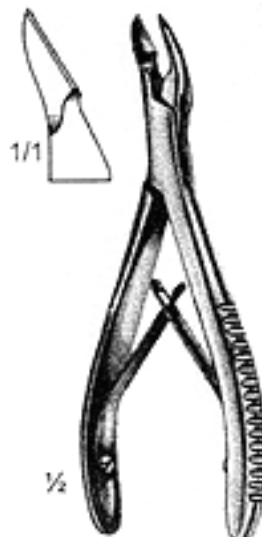

14-076-15
15cm



14-077-17
17cm

Cleveland

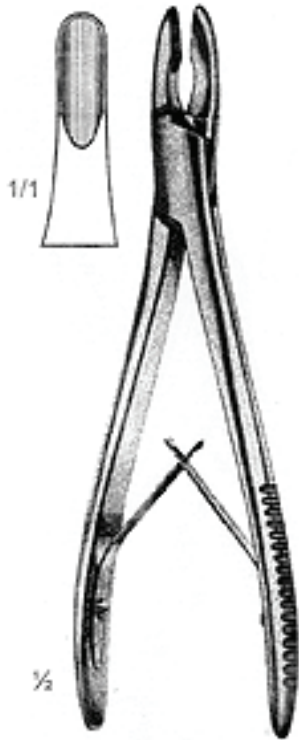

14-078-20
 20 cm
 Adson

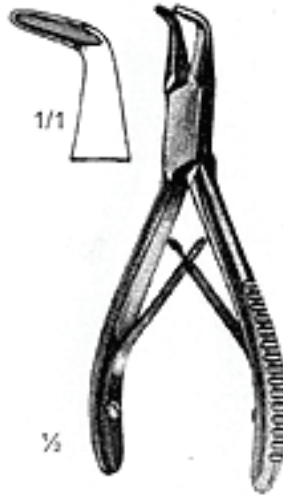

14-079-13
 13.5 cm

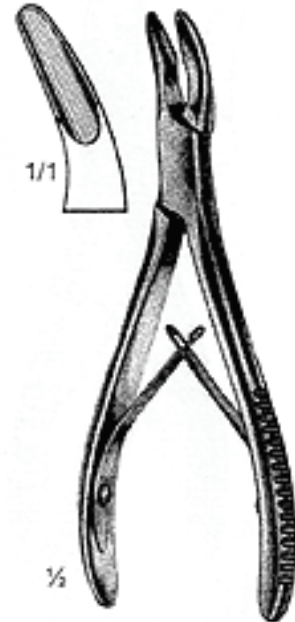

14-080-17
 17 cm

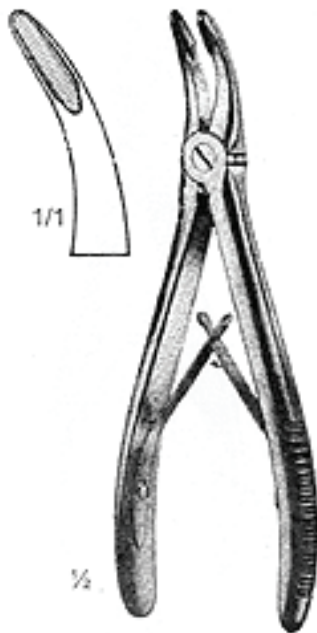

14-081-00

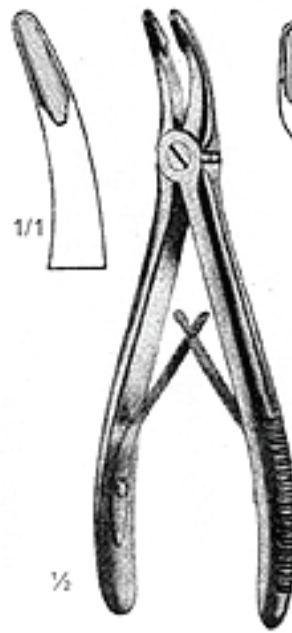

14-082-00

Jansen

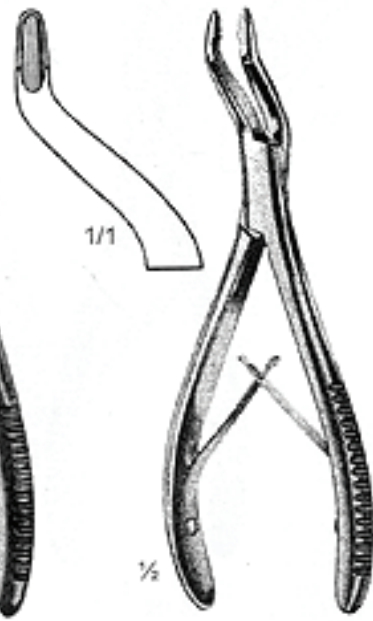

14-083-00

BONE RONGEUR FORCEPS
HOHLMEISSELZANGEN
PINZAS GUBIAS



14-084-17
17.5 cm



14-085-14
14 cm

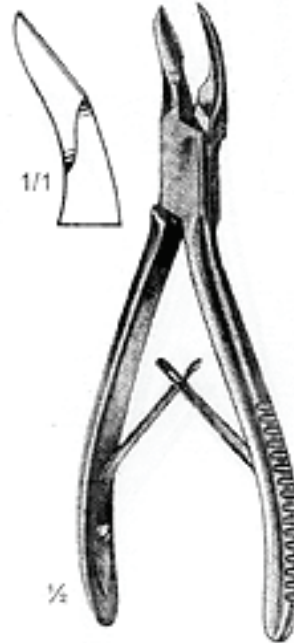

14-086-17
17.5 cm

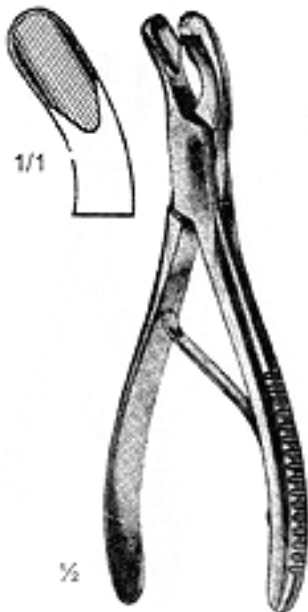

14-087-17
17 cm
Luer



14-088-17
17 cm



14-089-16
16 cm

Cleveland-Gardner

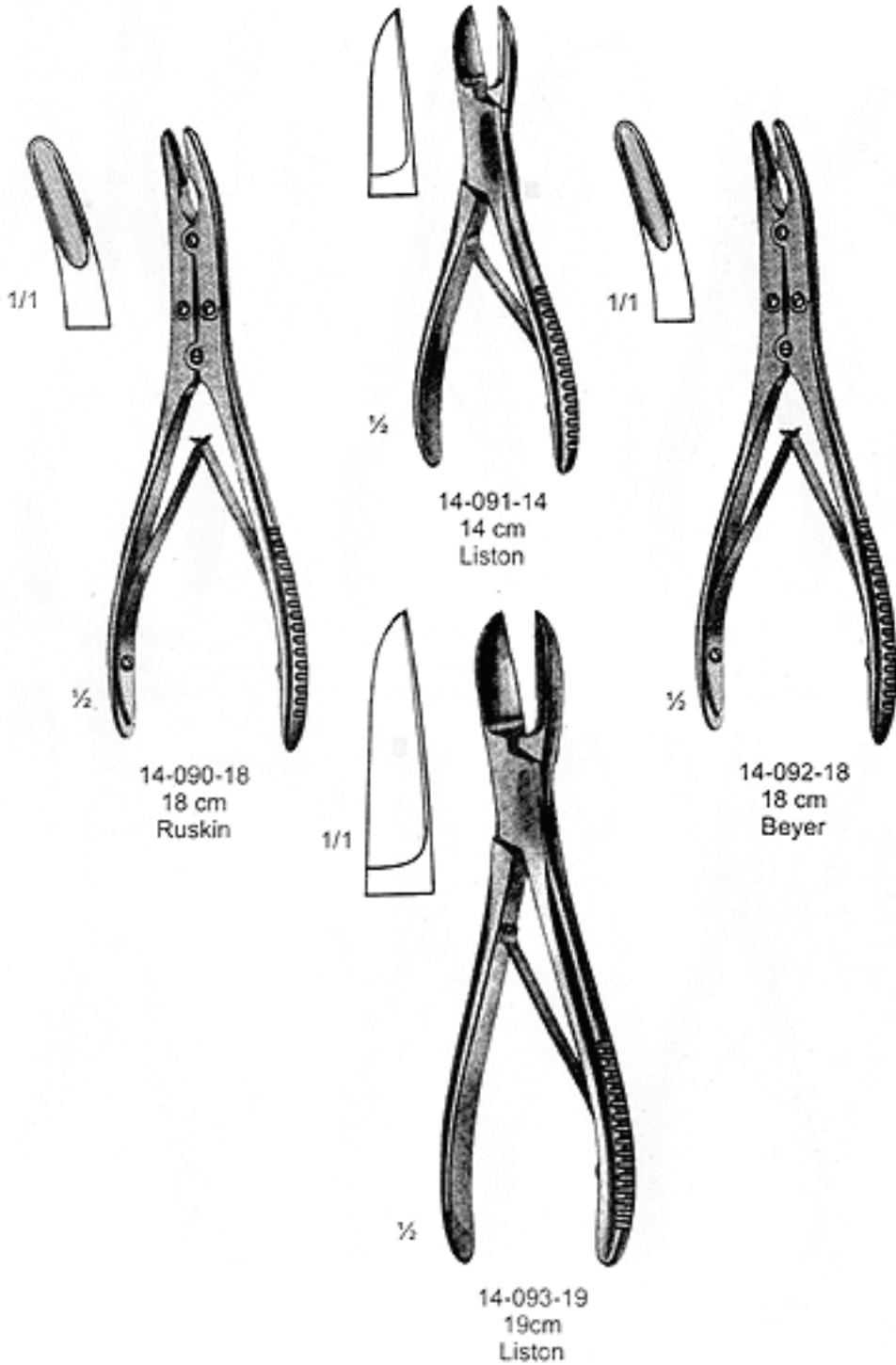

BONE RONGEUR FORCEPS
HOHLMEISSELZANGEN
PINZAS GUBIAS

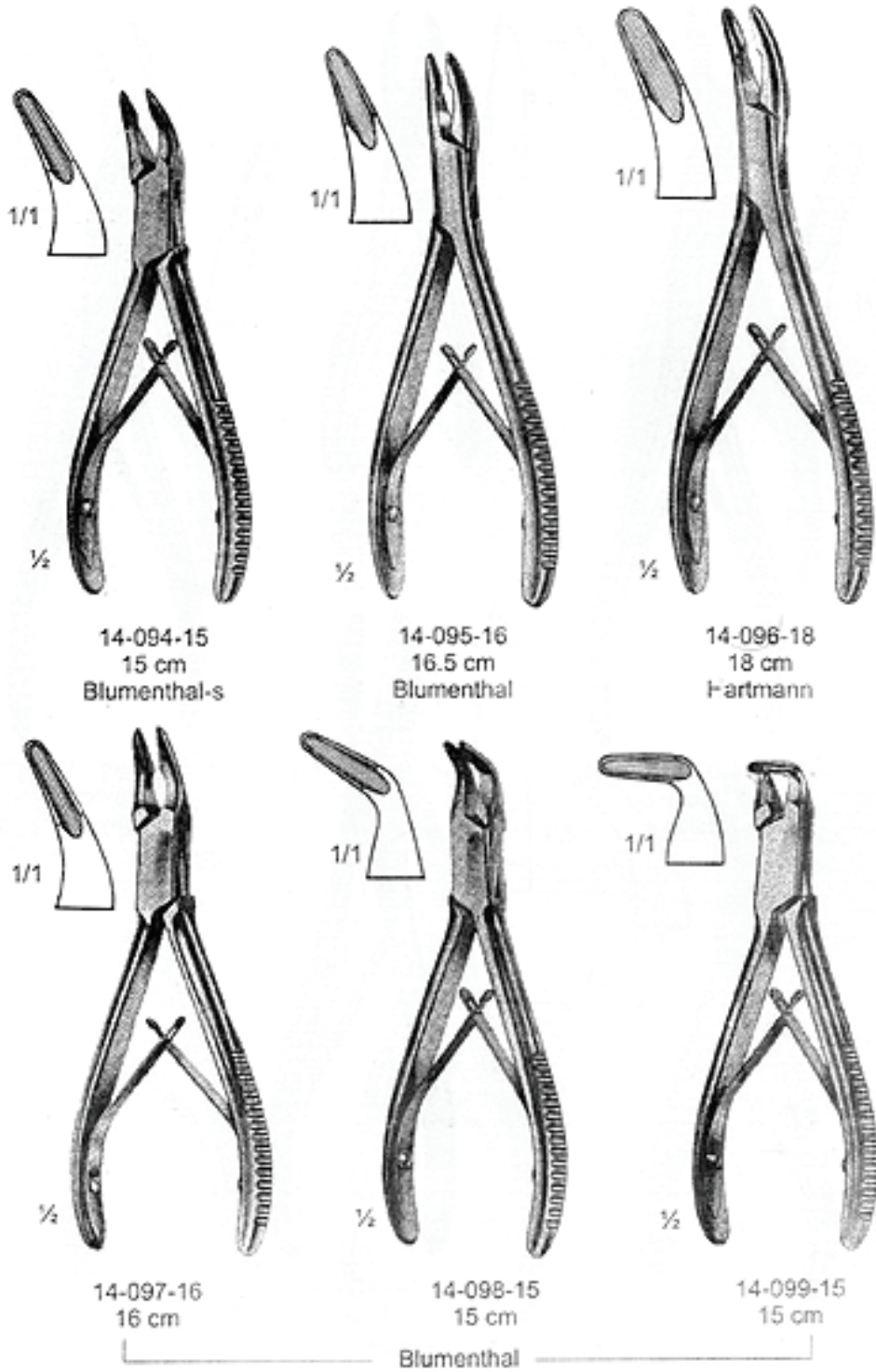

Department

15

MOUTH GAGS AND TONGUE RETRACTOR
MUNDSPERER UND ZUNGENHALTER
ABRE BOCAS Y ABAJA LENGUA

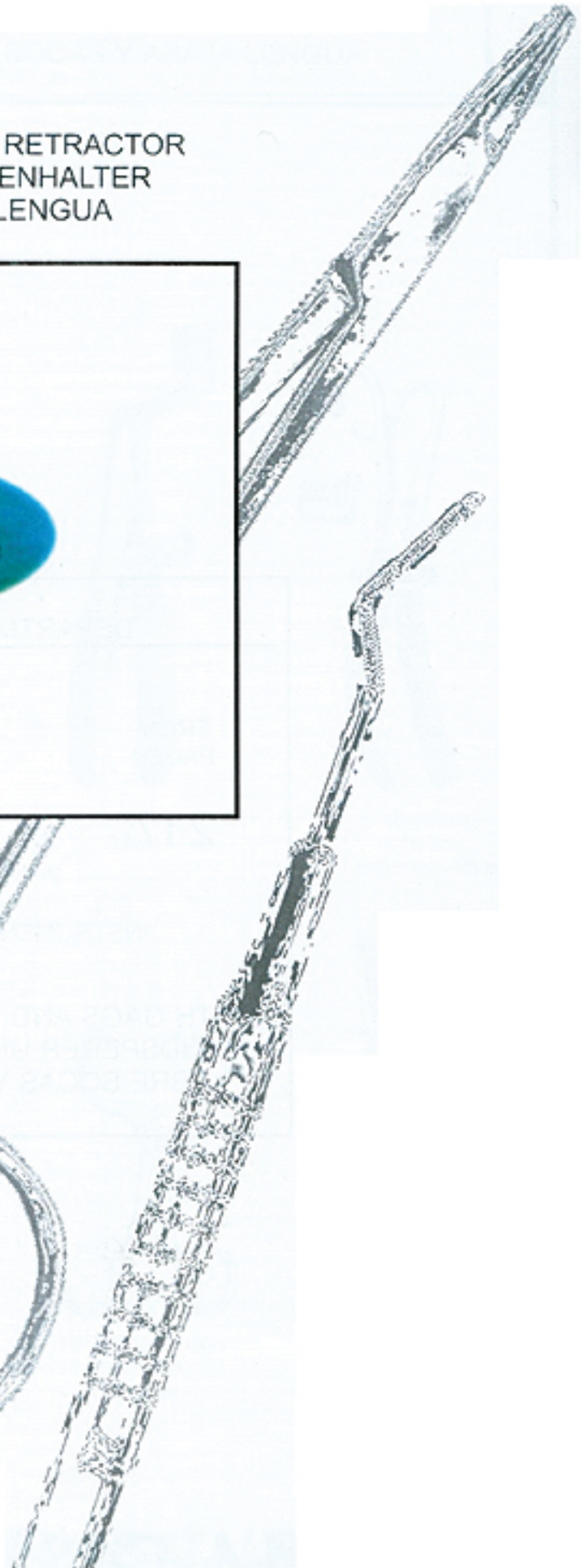
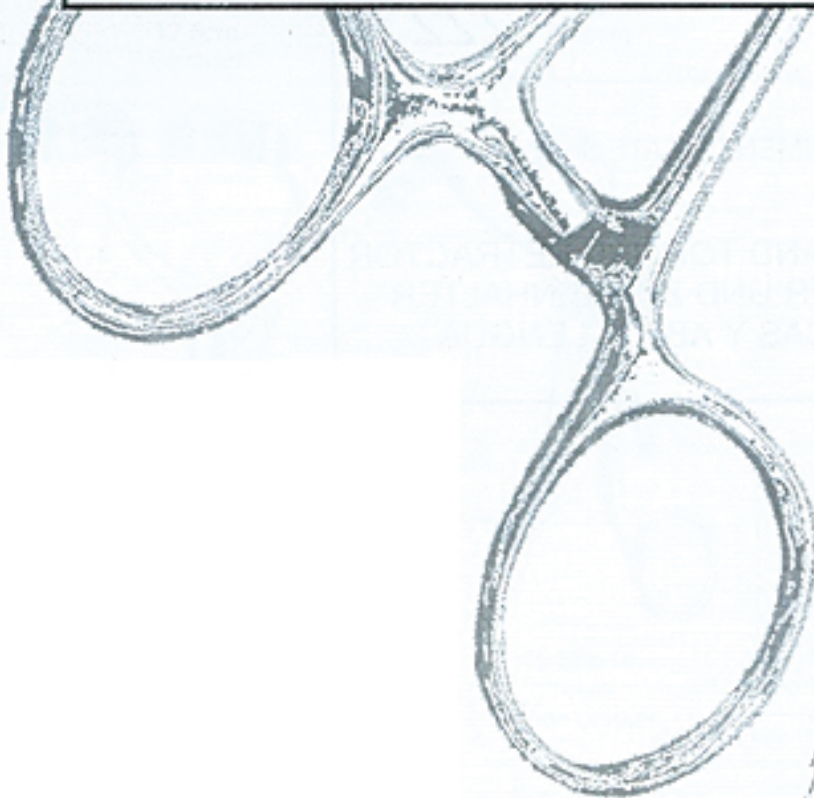
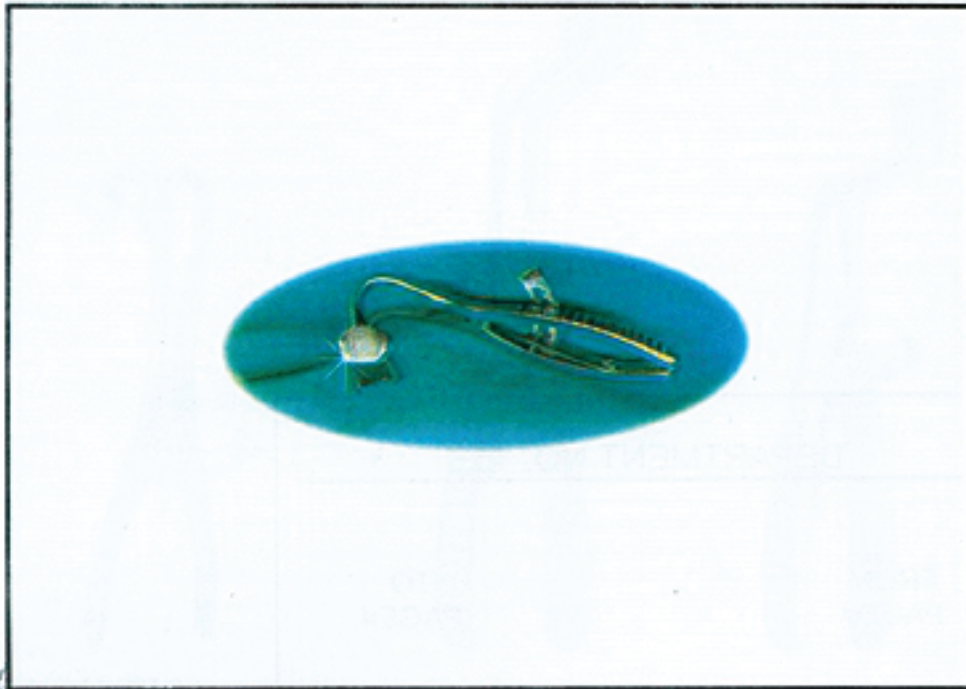

DEPARTMENT NO. 15

FROM
PAGE#

217

TO
PAGE#

222

INSTRUMENTS CATEGORY

MOUTH GAGS AND TONGUE RETRACTOR
MUNDSPERER UND ZUNGENHALTER
ABRE BOCAS Y ABAJA LENGUA



1/2

15-001-12
 12.5cm
 Denhart



1/2

15-002-18
 18.5cm

Roser-Konig

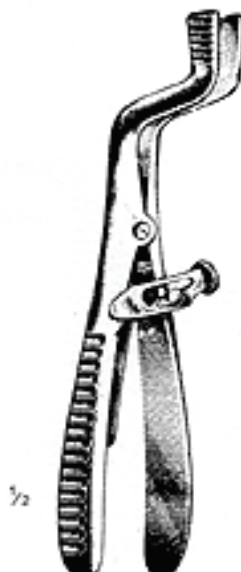

1/2

15-003-16
 16cm



1/2

15-004-15
 15.5cm
 Fergusson-Ackland

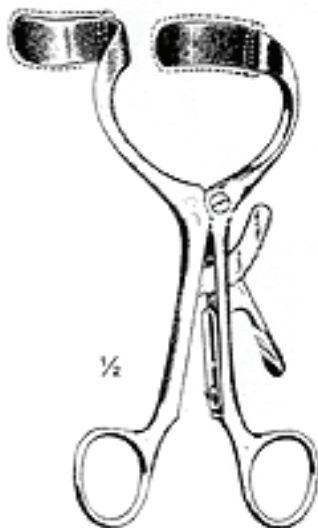

1/2

15-005-12
 12cm
 Doyen-Collin

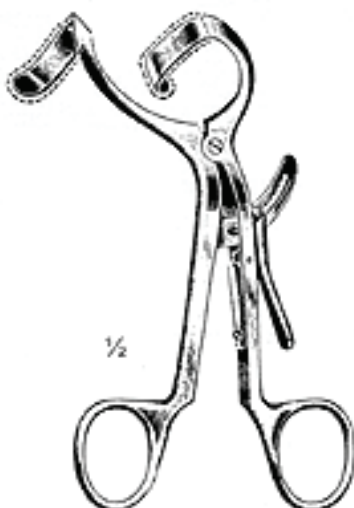

1/2

15-006-14
 14cm
 Doyen-Jansen



1/2

15-007-10(10 cm)
 15-007-14(14 cm)
 Molt



1/2

15-008-13
 13cm
 Heister

MOUTH GAGS
MUNDSPERRER
ABRE-BOCAS



15-050-09(9CM)
15-050-11(11CM)
15-050-13(13CM)
15-050-15(15CM)
Jennings

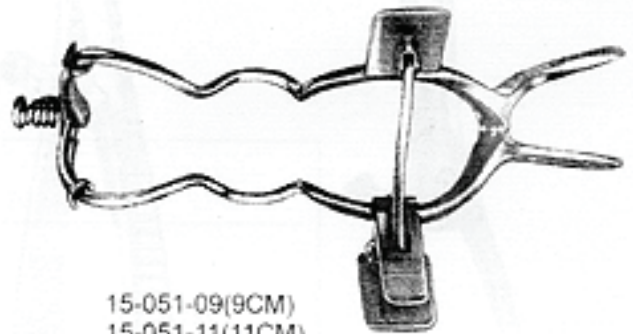

15-051-09(9CM)
15-051-11(11CM)
15-051-13(13CM)
15-051-15(15CM)
Seemann-Seiffert
(Self-retaining)



15-052-11(11CM)
15-052-13(13CM)
15-052-15(15CM)

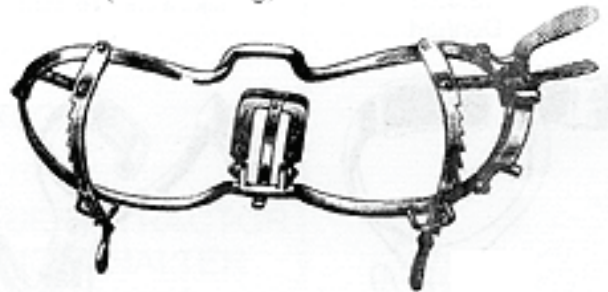

15-053-13(13CM)

Whitehead

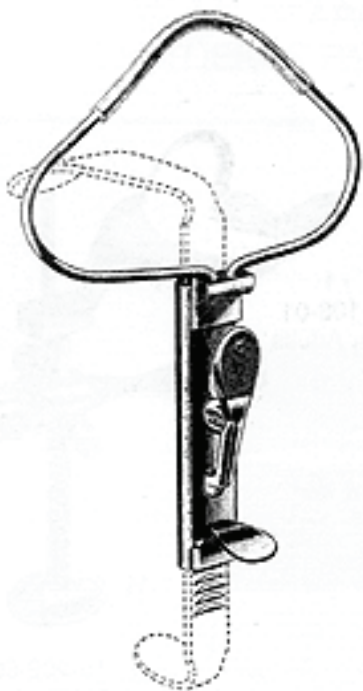

15-054-00

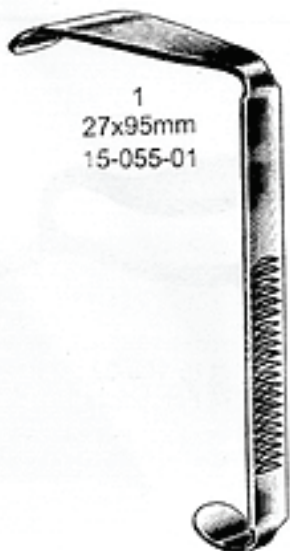

1
 27x95mm
 15-055-01



2
 22x85mm
 15-055-02



3
 22x70mm
 15-055-03

1-3
 15-055-00
 McIvor



15-056-00



1
 27x105mm
 15-057-01

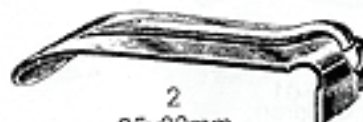

2
 25x90mm
 15-057-02



3
 25x75mm
 15-057-03



4
 22x60mm
 15-057-04



5
 20x25mm
 15-057-05

1-5
 15-057-00
 Davis-Boyle

TONGUE DEPRESSOR
 ZUNGEN-UND WATTEROLLENHALTER
 ABAISSE-LANGUE AVEC ABAISSE-TAMPON



3
 15-108-03
 For Adults



1
 15-108-02
 For Adults

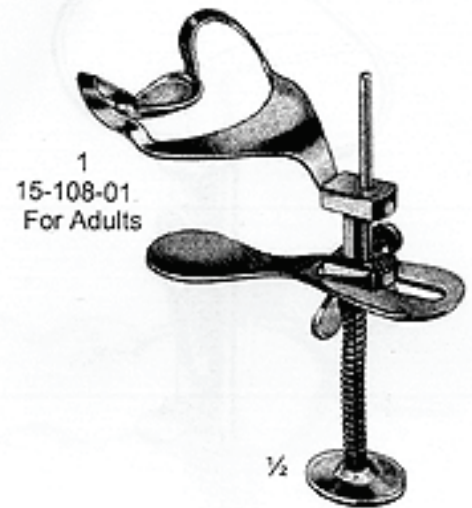

1
 15-108-01
 For Adults

1/2
 15-109-00
 Automaton



1
 15-110-01
 For Children



2
 15-110-02
 For Children



3
 15-110-03
 For Children

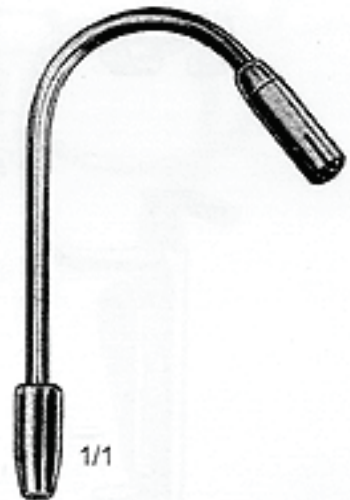

1/1
 15-111-00
 Saliva Ejectors(metal)

Department

16

DISSECTING SCISSORS
PRAPARIERSCHEREN
TIJERAS PARA PREPARACIONES

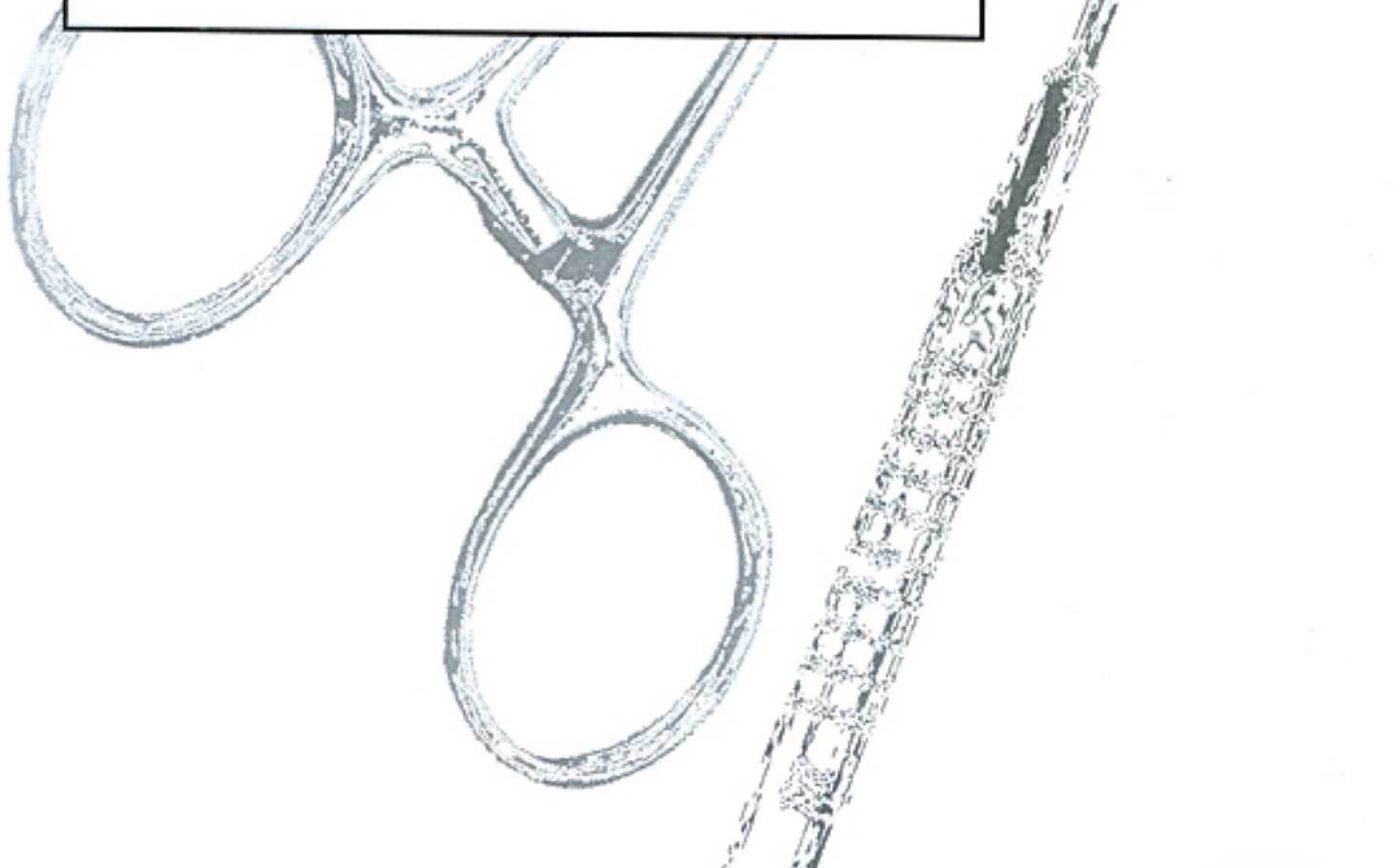
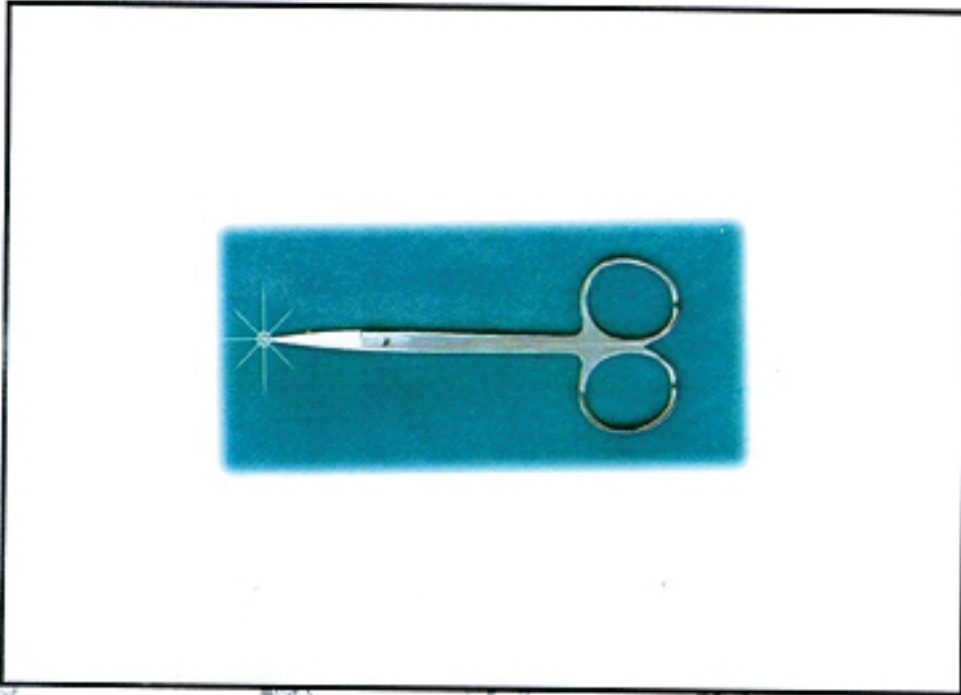

DEPARTMENT NO. 16

FROM
PAGE#

223

TO
PAGE#

234

INSTRUMENTS CATEGORY

DISSECTING SCISSORS
PRAPARIERSCHEREN
TIJERAS PARA PREPARACIONES



16-001-14
14.5 cm



16-002-14
14.5 cm



16-003-14
14.5 cm



16-004-14
14.5 cm



16-005-14
14.5 cm



16-006-14
14.5 cm



OPERATING SCISSORS
 CHIRURGISCHE SCHEREN
 TIJERAS PARA CIRUGIA

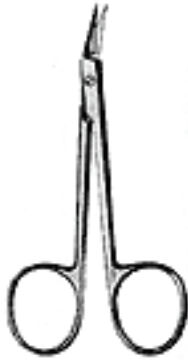
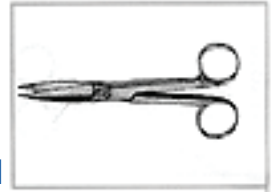

16-010-09
 9.5 cm
 O'Brien



16-009-12
 12.5 cm
 Northbent

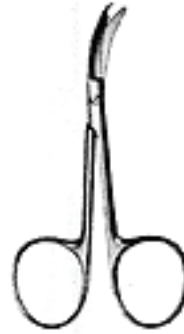

16-008-09
 9 cm
 Shortbent



16-007-09(9 cm)
 16-007-10(10.5 cm)
 16-007-13(13 cm)
 Spencer

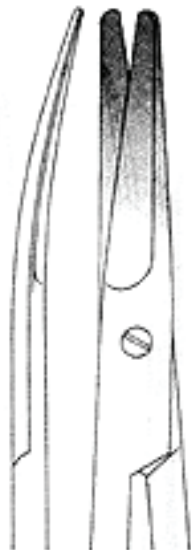

16-013-14

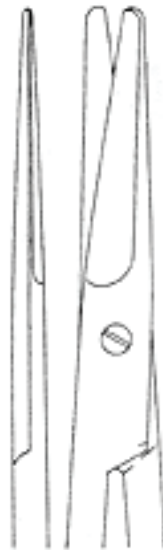

16-012-14



16-012-14
 16-013-14
 14.5 cm
 Mayo

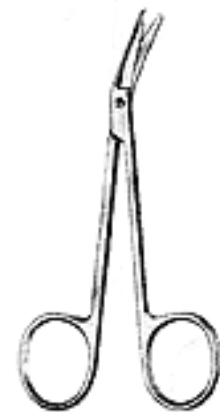

16-011-11
 11.5 cm

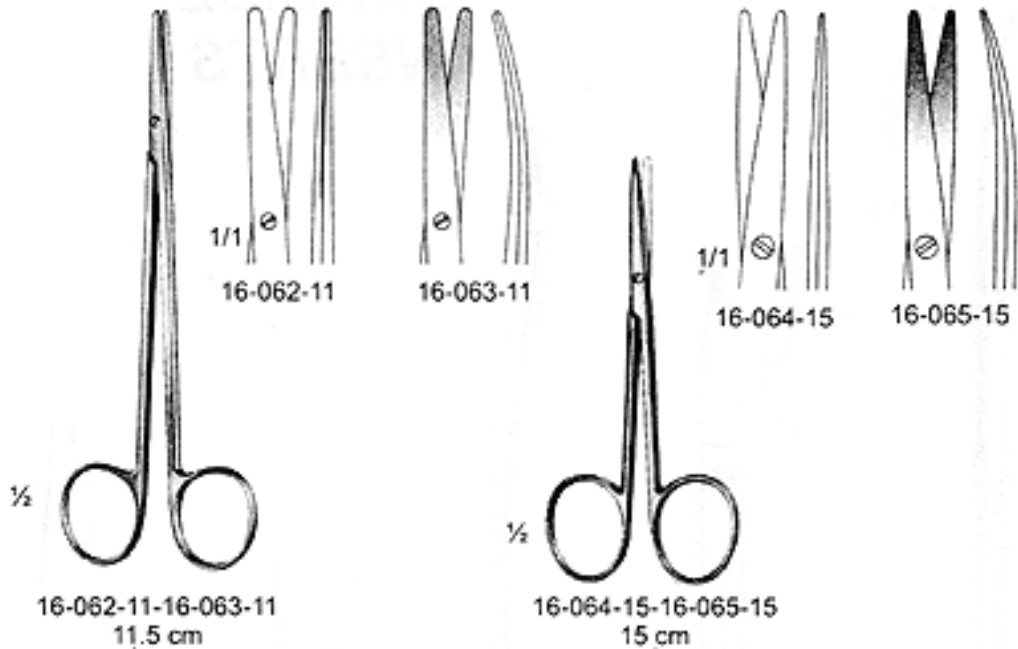

Metzenbaum

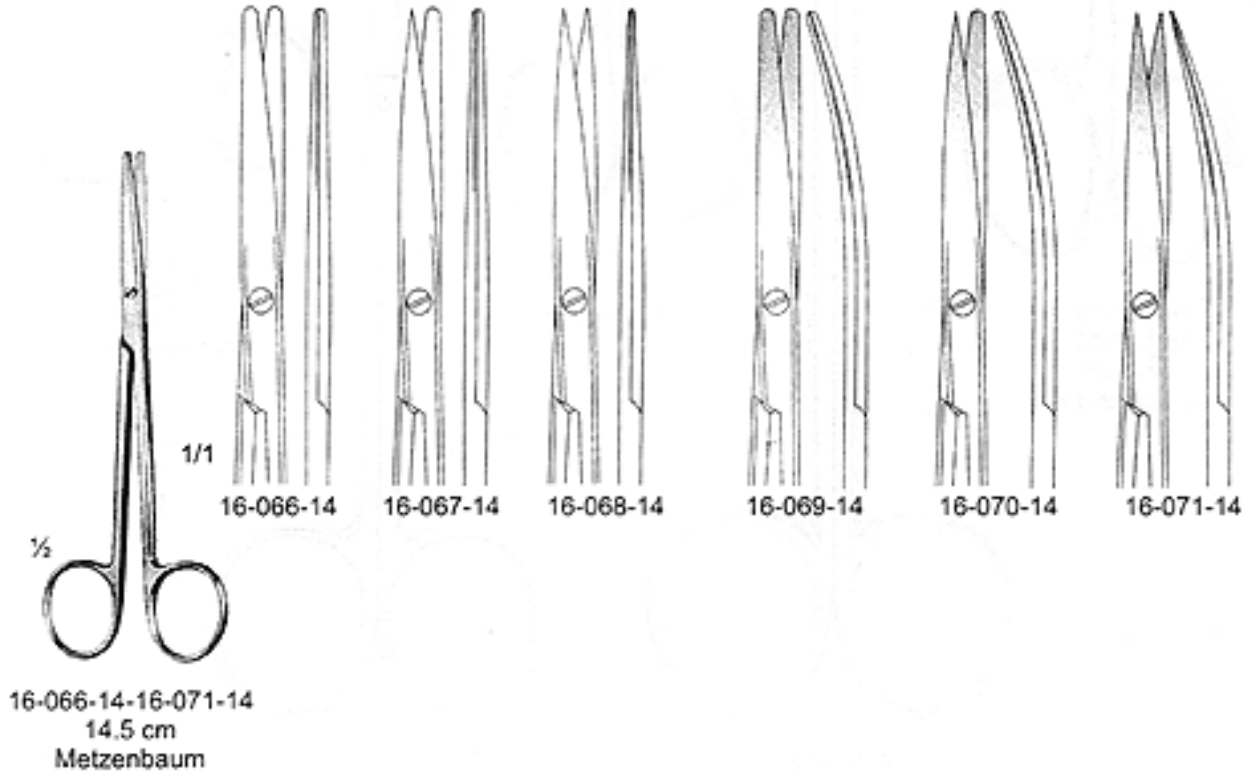



TUNGSTEN CARBIDE INSERTS

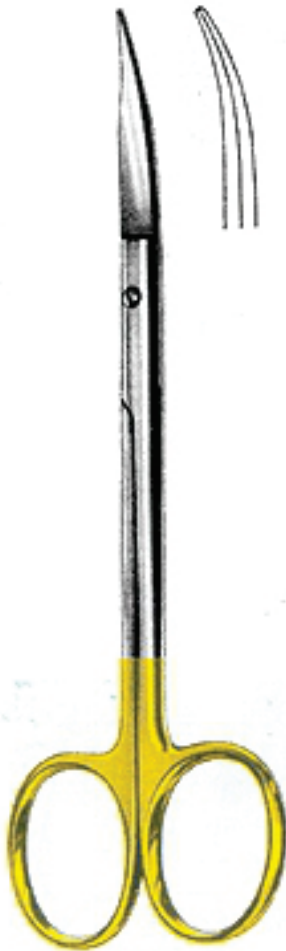

16-121-13 str
16-122-13 cur
13 cm
Goldmann-Fox

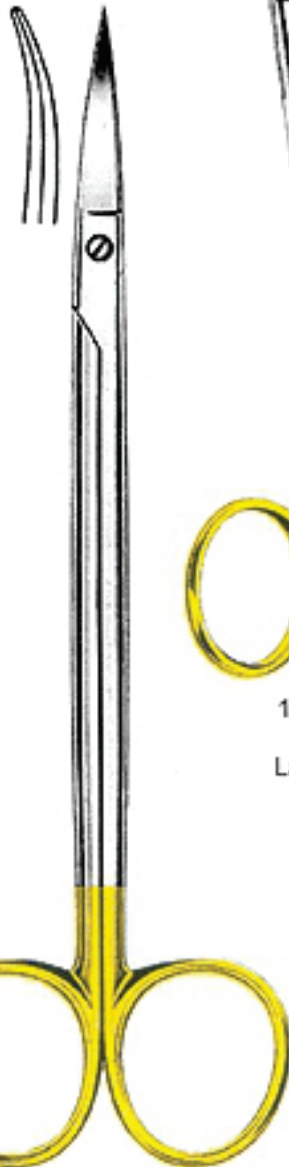

16-123-16 str
16-124-16 cur
16 cm
Kelly



16-125-11
11 cm
La Grange

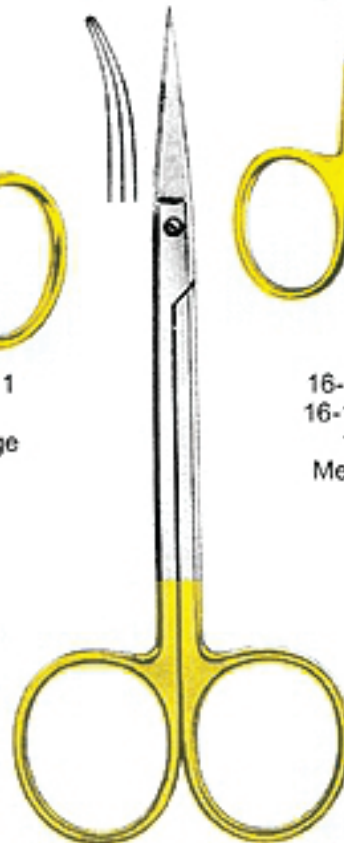

16-126-11 str
16-127-11 cur
11.5 cm

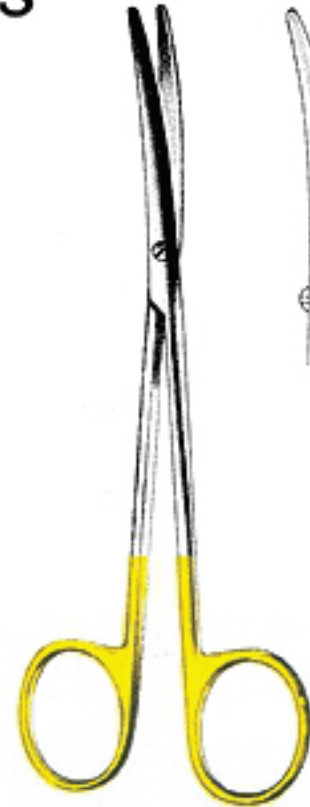

16-128-14 str
16-129-14 cur
14.5 cm
Metzenbaum



16-178-11-16-179-11
 11.5 cm

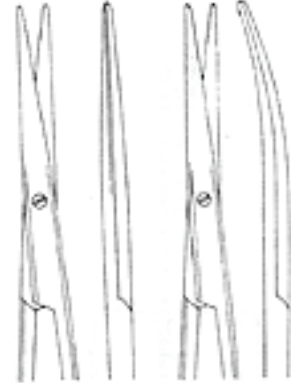

16-178-11 16-179-11

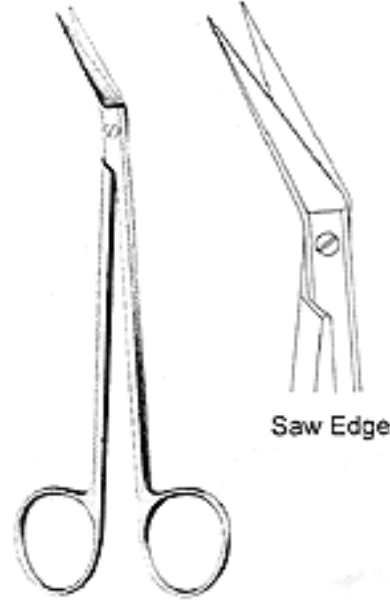

Saw Edge

16-180-16
 16 cm
 Locklin



16-181-17-16-182-17
 17 cm
 Dean

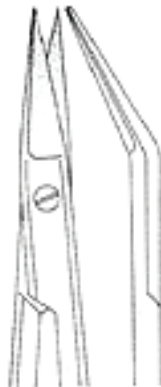

16-181-17



16-182-17
 Saw Edge

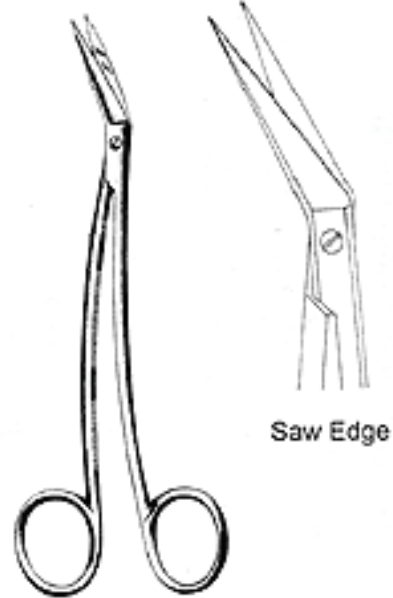

Saw Edge

16-183-16
 16 cm
 locklin

FINE OPERATING SCISSORS
FEINE CHIRURGISCHE SCHERE
TIJERAS FINAS PARA CIRUGIA



16-244-14



16-245-14

16-244-14-16-245-14
14 cm
Sanvenero



16-246-14

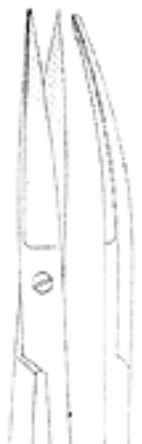

16-247-14

16-246-14-16-247-14
14 cm
Joseph

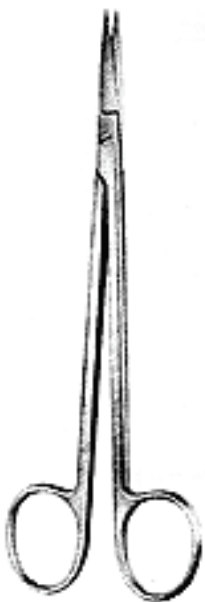

16-248-16



16-248-18



16-249-16

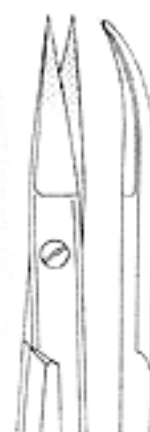

16-249-18

16-248-16-16-249-18
16 cm
18 cm
Kelly

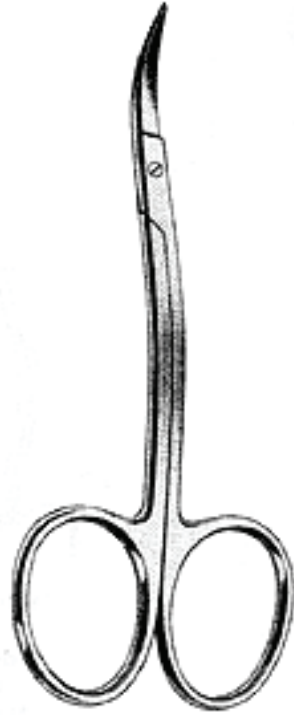

16-300-11
 11.5 cm
 La Grange

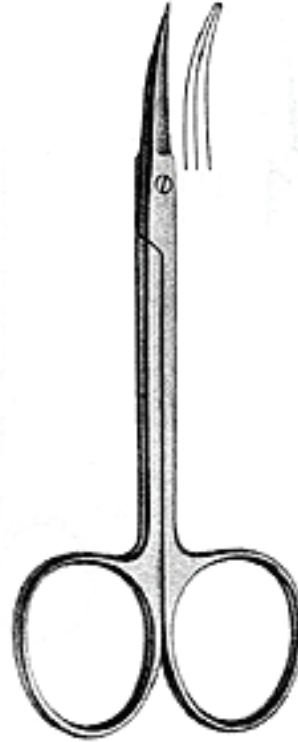

16-301-11
 11.5 cm
 Iris

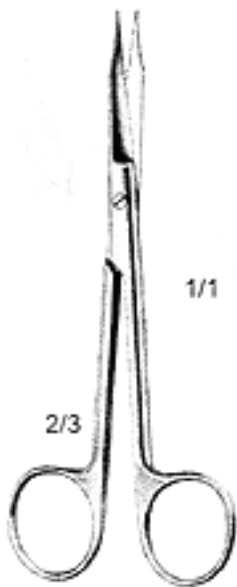

1
 16-302-13
 13 cm



1/1

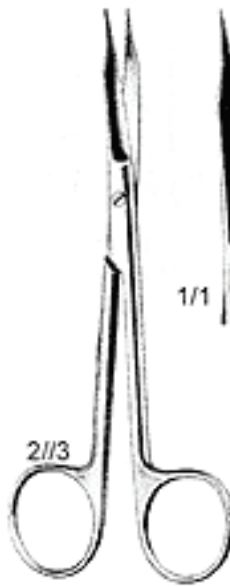

2
 16-303-13
 13 cm



1/1



16-304-11
 11 1/2 cm

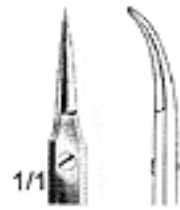

1/1

GUM SCISSORS
ZAHNFLEISCH SCHEREN
TIJERAS PARA ENCIAS

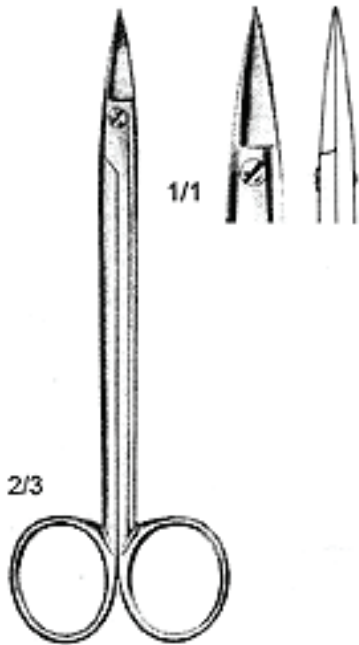

1
16-305-12
12.5 cm

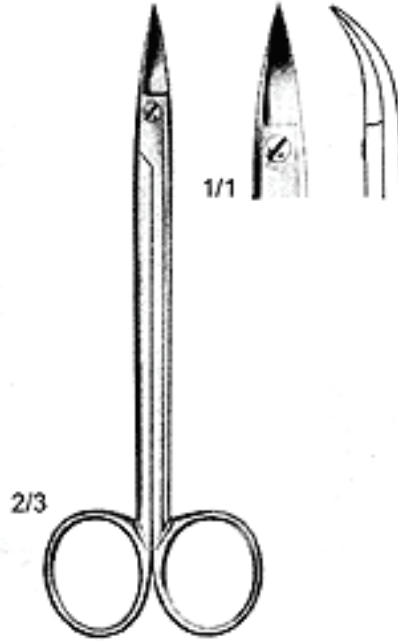

2
16-306-12
12.5 cm

Quinby

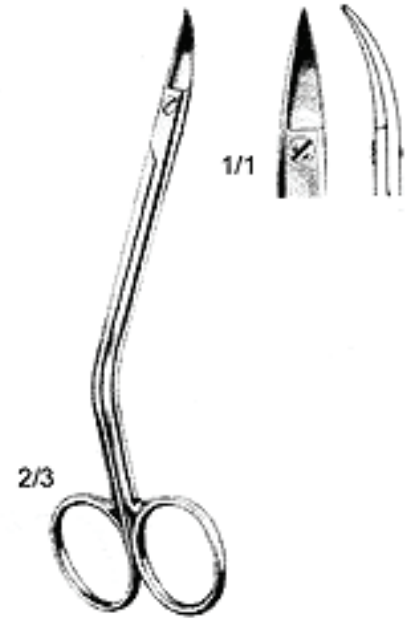

16-307-12
12 cm
Neumann

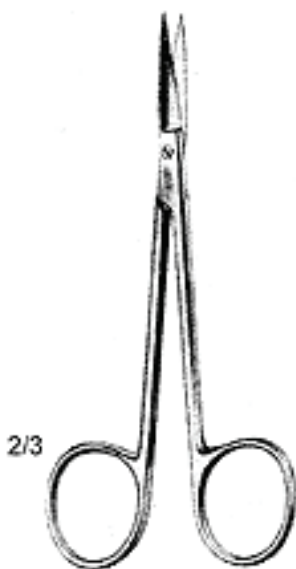

1-4
16-308-11
11 cm
Iris

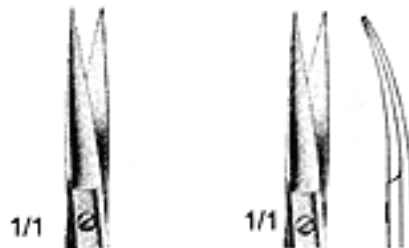

16-309-11
11 cm

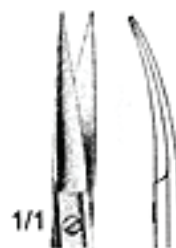

16-310-11
11 cm



16-311-11
11 cm



16-312-11
11 cm



16-313-12
 12 cm
 Noyes



16-314-11
 11 cm



16-315-11
 11 cm

Westcott



16-316-00



1/1

16-317-15
 15 cm



16-318-15
 15 cm



16-319-15
 15 cm
 Reill
 Saw Edge

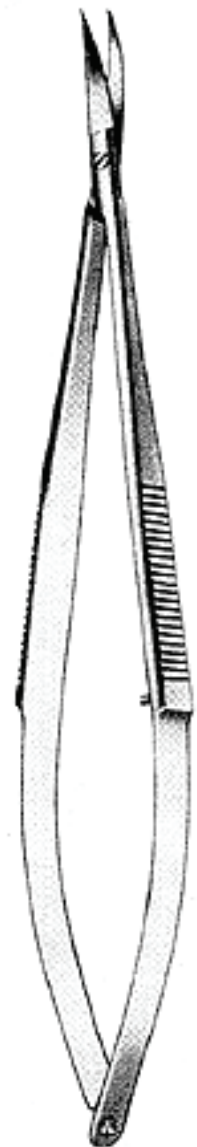

16-320-15
 15 cm
 Castroviejo

CROWN SCISSORS - CISEAUX A
KRONEN SCHEREN
TIJERAS PARA CORONOS

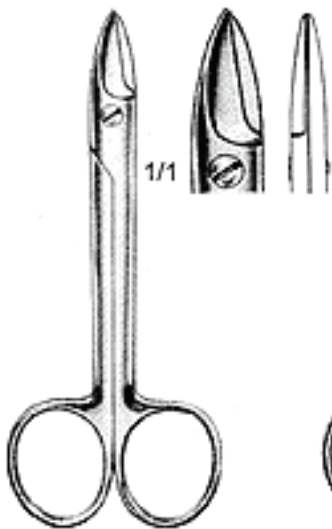

16-365-10
10.5 cm
Beebee

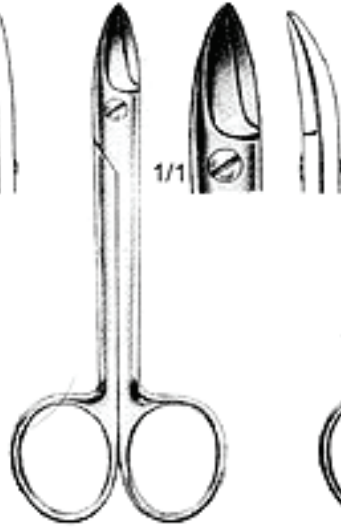

16-366-10
10.5 cm
Beebee

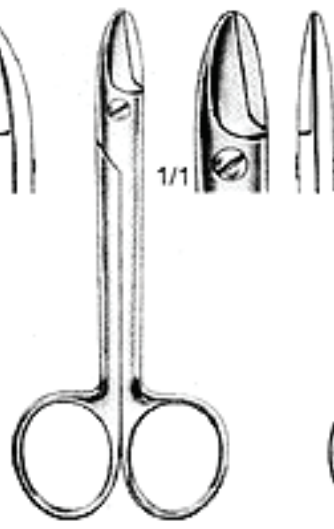

16-367-10
10.5 cm
Beebee

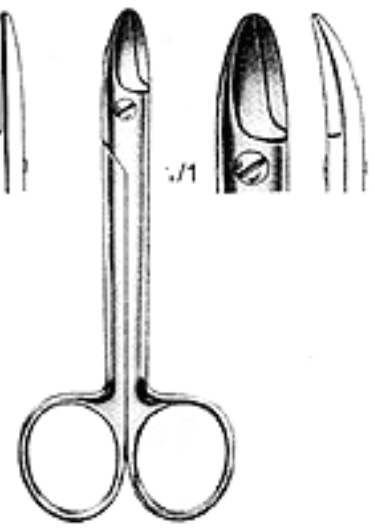

16-368-10
10.5 cm
Beebee

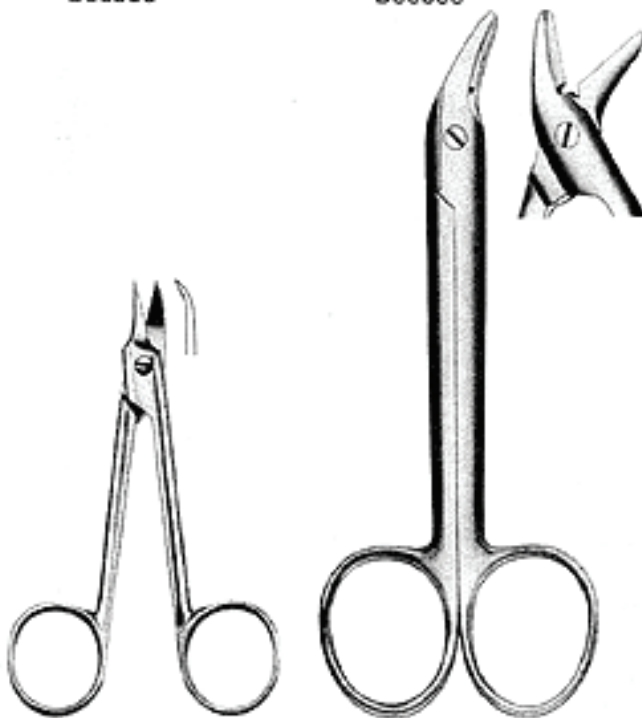

16-369-10
10.5 cm

16-370-12
12 cm
Universal



16-371-117
17 cm

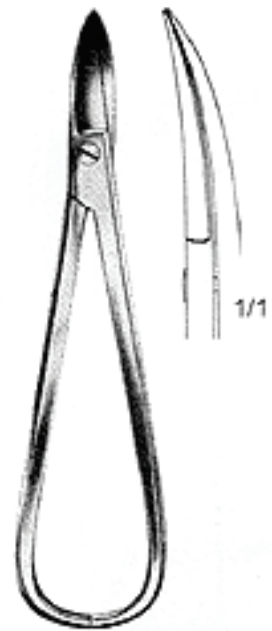

16-372-117
17 cm

Department

17

TISSUE RETRACTORS
WEICHTEILHAKEN
SEPARADORES

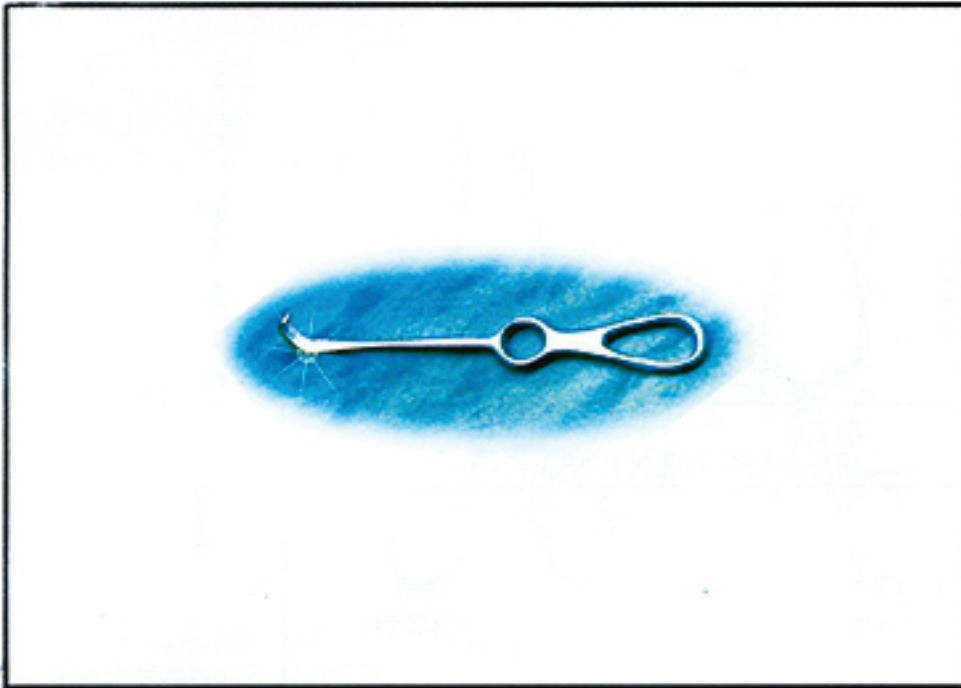

DEPARTMENT NO. 17

FROM
PAGE#

235

TO
PAGE#

244

INSTRUMENTS CATEGORY

TISSUE RETRACTORS
WEICHTEILHAKEN
SEPARADORES



17-001-10
10.5 cm

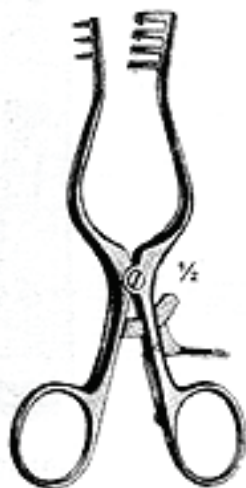

17-002-13

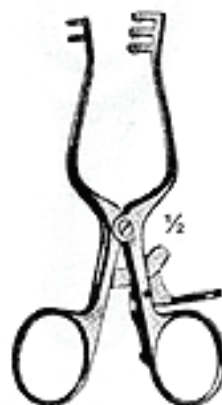

17-003-10
10.5 cm



17-004-13
13 cm

Sharp Weillaner Blunt



Sharp



Blunt

17-005-07(Sharp)
17-006-07(Blunt)
7 cm
Finsen



Sharp



Blunt

17-007-10(Sharp)
17-008-10(Blunt)
10 cm
Alm

RETRACTORS - MOUTH GAGS
 ECARTEURS - OUVRE-BOUCHES
 SEPARADORES - ABRE-BOCAS

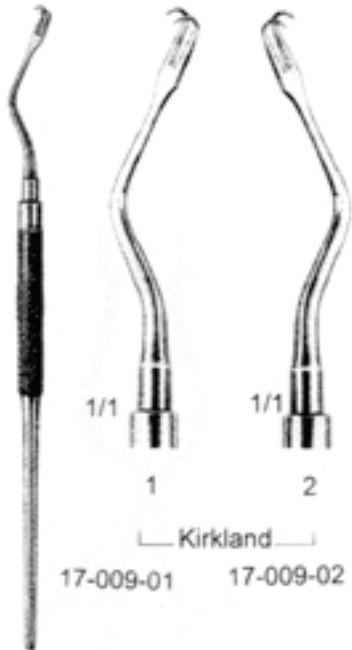

1/1 1 2
 Kirkland
 17-009-01 17-009-02

17-009-18
 18 cm



17-010-11
 11 cm
 Simplex



17-011-00
 Minnesota



17-011-14 14 cm
 17-011-15 15 cm
 Wieder



17-012-13
 13 cm
 Farabeuf



1/2 1/2
 17-013-12 (12 cm)
 17-013-14 (14 cm)
 17-013-16 (16 cm)
 17-014-14 (14 cm)
 17-014-16 (16 cm)
 17-014-18 (18 cm)

Sternberg



1/2 1/2
 17-015-00 17-016-00
 Bruenings



1/1 1/2 1/1 1/2
 1 2
 17-017-00 17-018-00
 Luniatschek

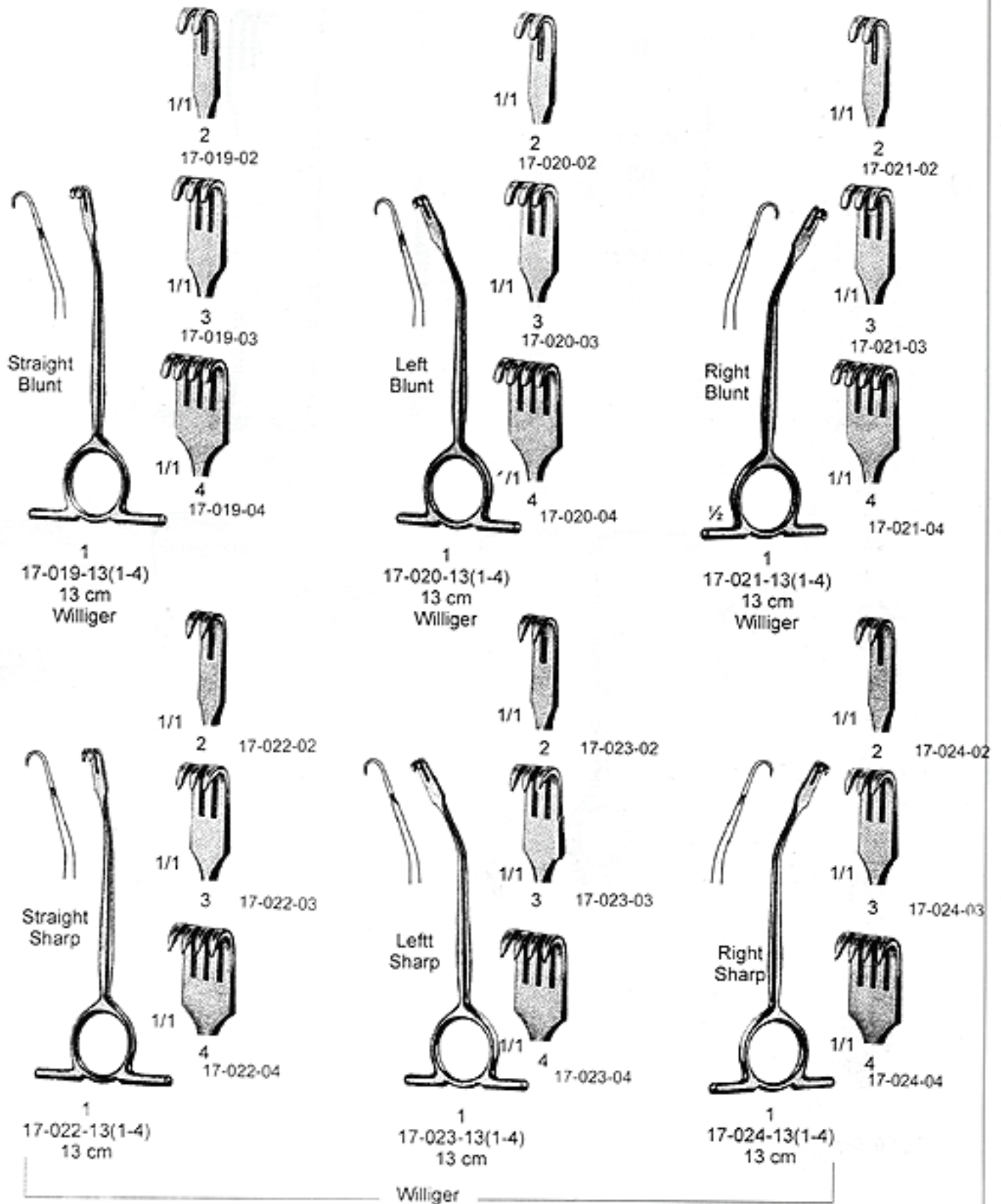

RETRACTORS ECARTEURS SEPARADORES

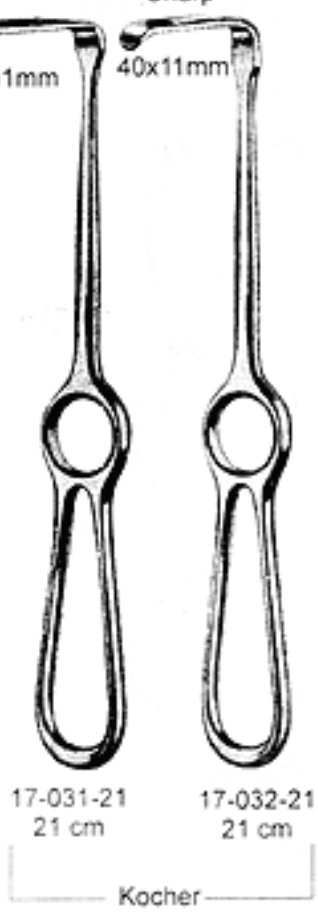
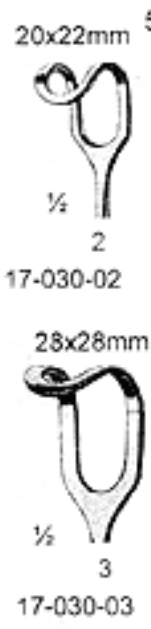
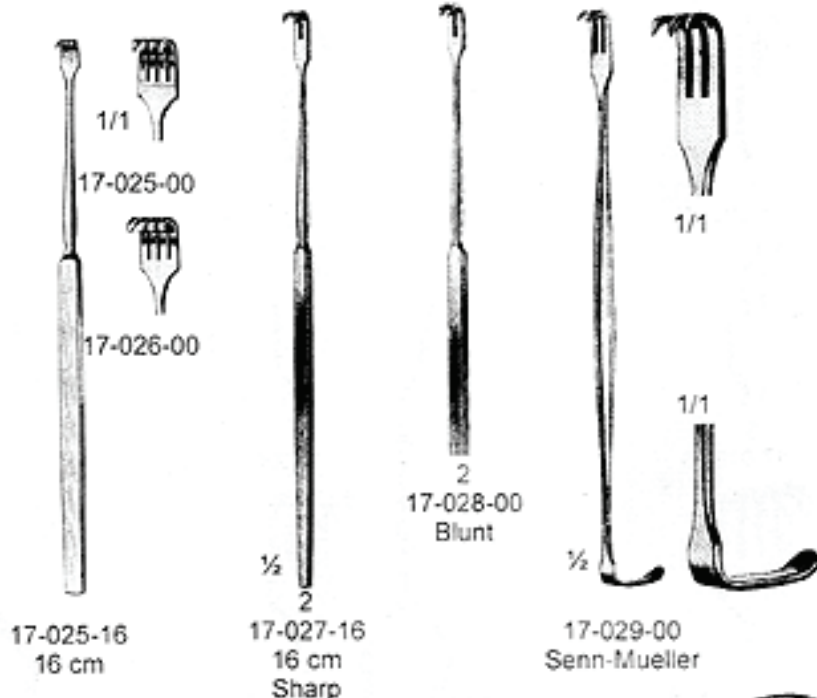



1-5
 17-034-21
 21 cm
 Langenbeck

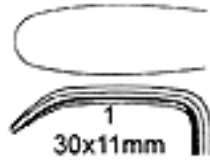

1
 30x11mm
 17-034-01

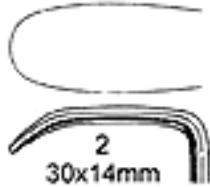

2
 30x14mm
 17-034-02



3
 30x16mm
 17-034-03

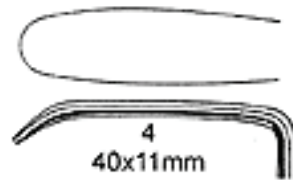

4
 40x11mm
 17-034-04



5
 50x11mm
 17-034-05



1/2



1
 17-035-01



2
 17-035-02



3
 17-035-03



4
 17-035-04

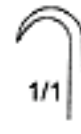

1/1

Sharp



5
 17-035-05



6
 17-035-06



7
 17-035-07



8
 17-035-08

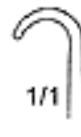

1/1

Blunt

**SOFT TISSUE RETRACTORS
WEICHTEILHAKEN
SEPARADORES**

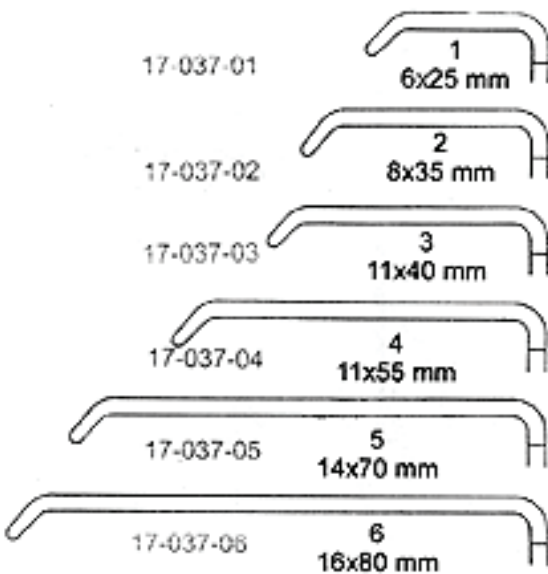
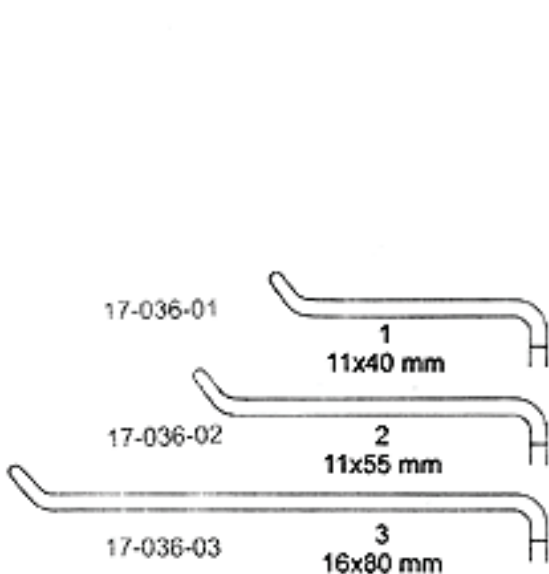
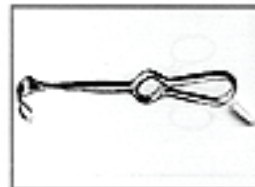

1-3
17-036-22
22 cm
Obwegeser



1-6
17-037-21
21.5 cm
Obwegeser
(Kocher-Langenback)

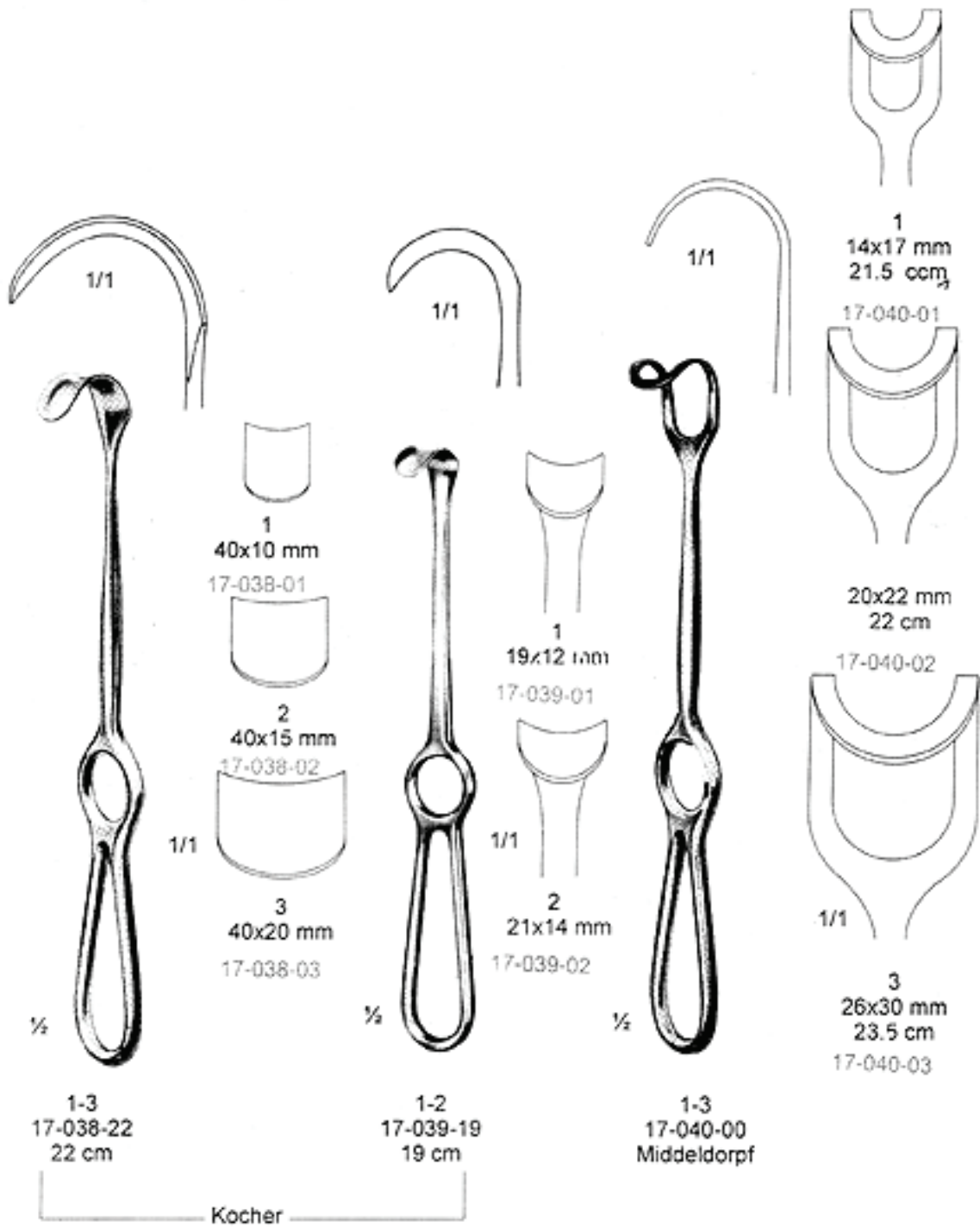

TISSUE RETRACTORS
WEICHTEILHAKEN
SEPARADORES

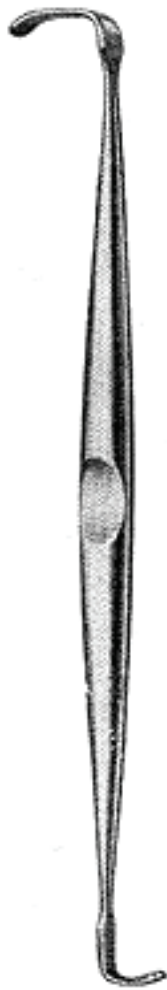

17-041-00
8x4 mm/15x5 mm
Ragnell - Davis



55x11 mm



1-2
17-042-22
22cm
Muller



1
25x7 mm
17-043-01



25x7 mm
17-043-02



1-2
17-043-00
Meyerding



33x20 mm



17-044-00
Wassmund



1
28x8 mm
17-045-01



2
35x11 mm
17-045-02

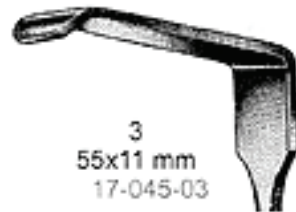

3
55x11 mm
17-045-03



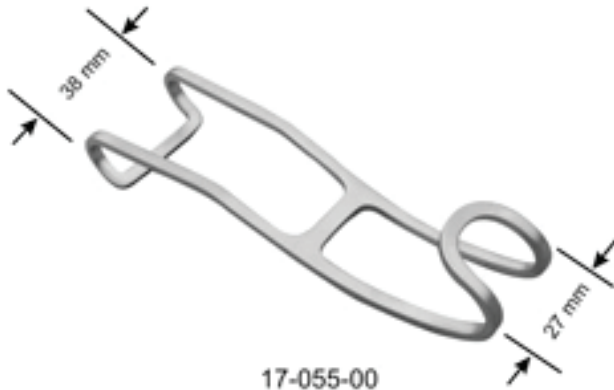

17-055-00
38 x 27 mm

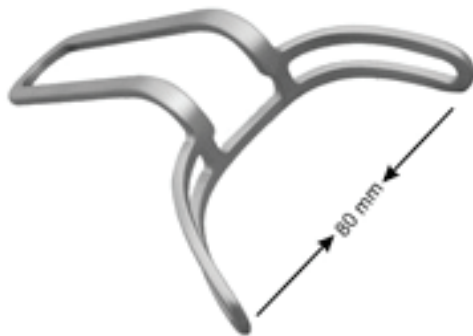

17-056-00
14 cm



Frazier (Fergusson)
17-057-06 Charr 6 mm
17-058-08 Charr 8 mm
17-059-10 Charr 10 mm
17-060-12 Charr 12 mm
18 cm

Department

18

ARTERY FORCEPS
ARTERIENKLEMMEN
PINZAS HEMOSTATICAS

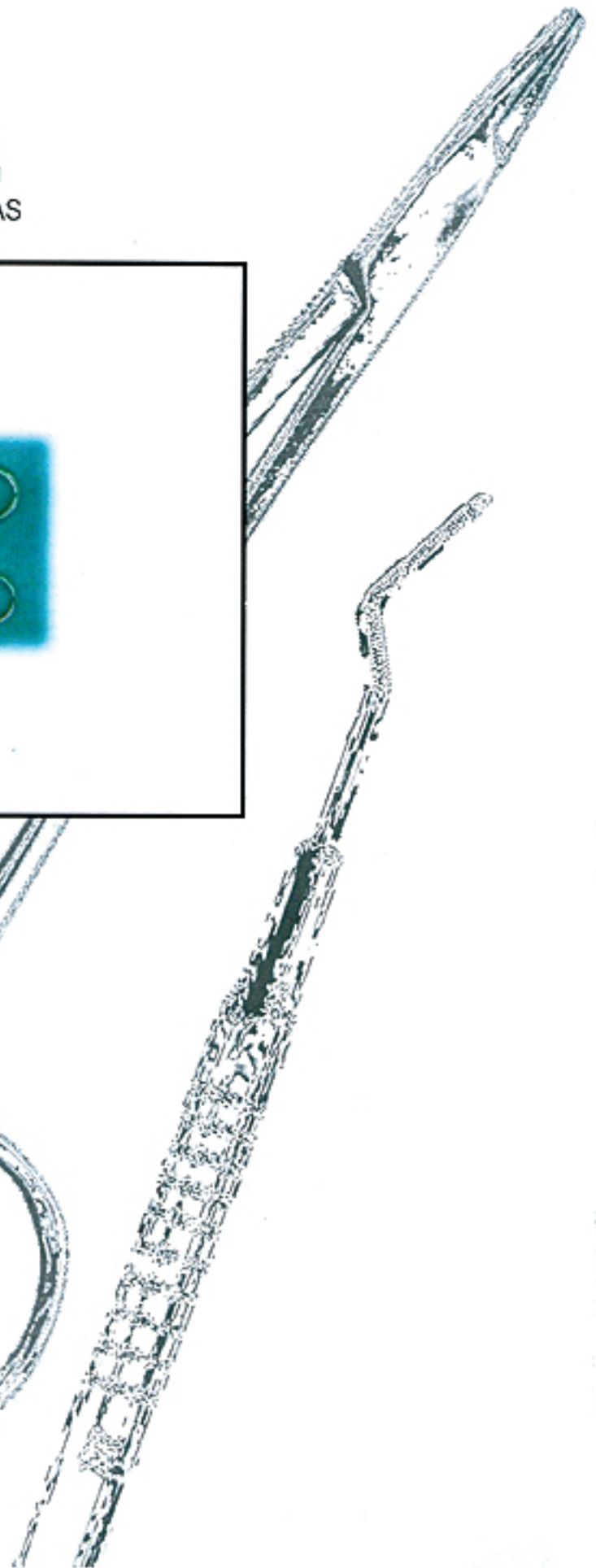
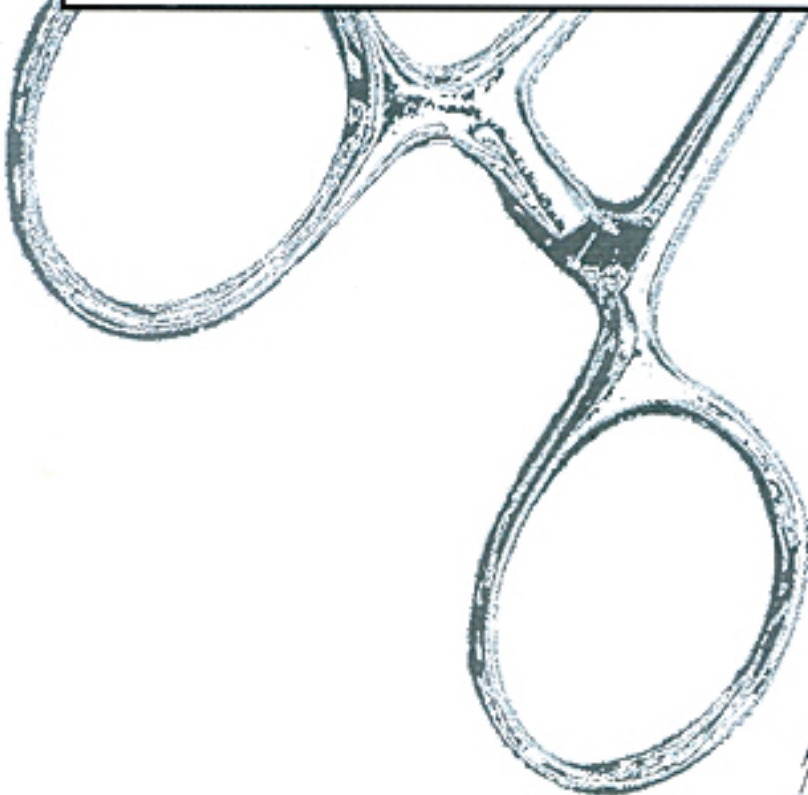
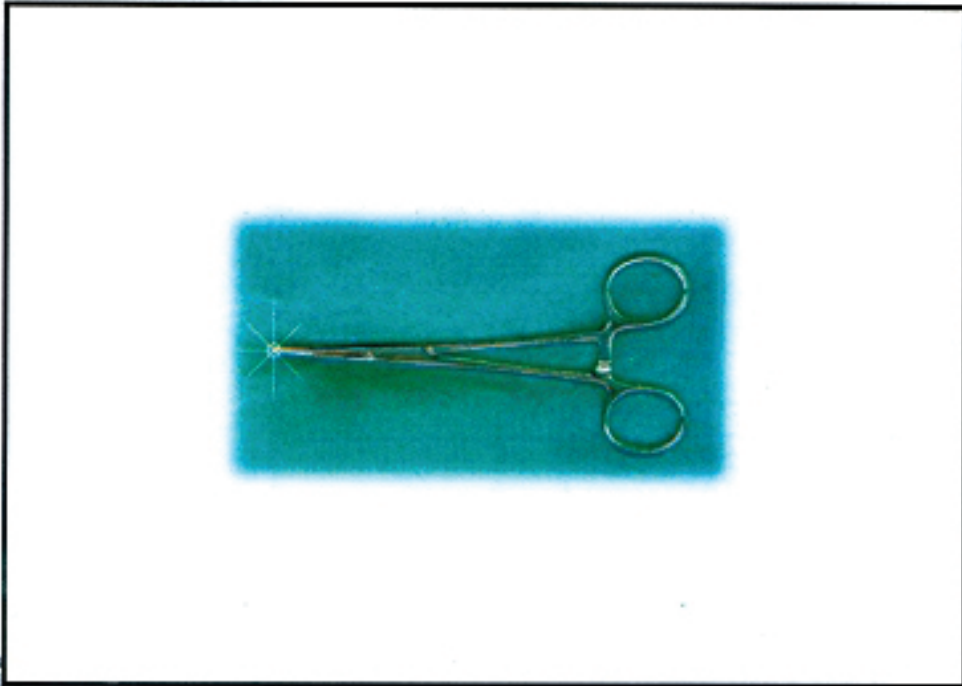

DEPARTMENT NO. 18

FROM
PAGE#

245

TO
PAGE#

253

INSTRUMENTS CATEGORY

ARTERY FORCEPS
ARTERIENKLEMMEN
PINZAS HEMOSTATICAS

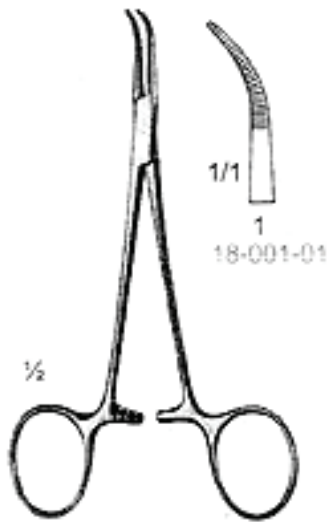

1-2
 18-001-14
 14 cm
 Baby-Mixer



1/1
 1
 18-001-01



2
 18-001-02

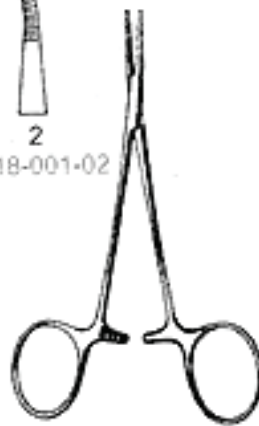

18-002-10-18-005-12
 Micro-Mosquito

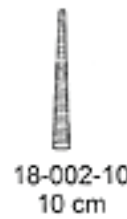

18-002-10
 10 cm



18-002-12
 12 cm



18-003-10
 10 cm



18-003-12
 12 cm



1/1
 18-004-10
 10 cm



18-004-12
 12 cm



-005-10
 10 cm



18-005-12
 12 cm

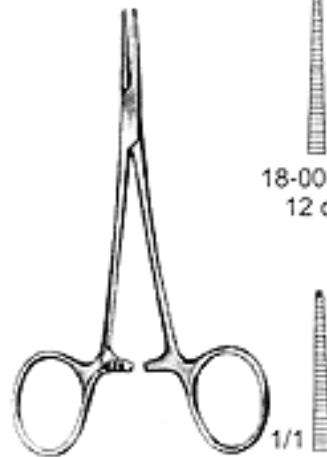

18-006-12-18-008-14
 Haisted-Mosquito



18-006-12
 12 cm



18-006-14
 14 cm



18-007-12
 12 cm



18-007-14
 14 cm



1/1
 18-008-12
 12 cm



18-008-14
 14 cm



18-009-12
 12 cm



18-009-14
 14 cm

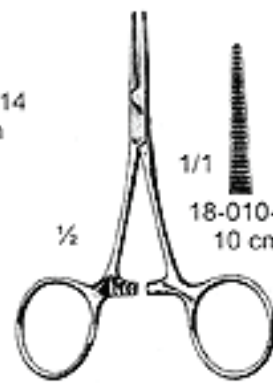

18-010-10-18-011-10
 10 cm
 Hartmann

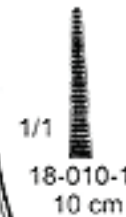

1/1
 18-010-10
 10 cm



18-011-10
 10 cm

ARTERY FORCEPS
ARTERIENKLEMMEN
PINZAS HEMOSTATICAS

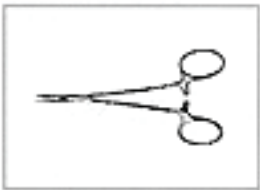

18-012-09 Str
18-013-09 Cur
9 cm
Micro-Hartmann

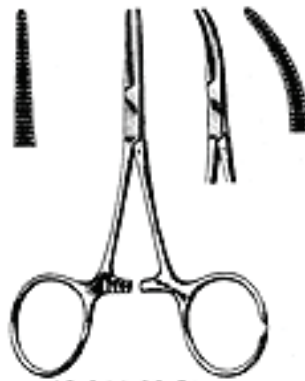

18-014-09 Str
18-015-09 Cur
9 cm
Baby-Mosquito



18-016-09 Str
18-017-09 Cur
9 cm
Baby-Mosquito 1x2 teeth



18-018-10-10-021-12
Micro-Mosquito



18-018-10
10 cm



18-018-12
12 cm



18-019-10
10 cm



18-019-12
12 cm



18-020-10
10 cm



18-020-12
12 cm



18-021-10
10 cm



18-021-12
12 cm

1x2 teeth



18-022-18-1. J25-21
 Halsted-Mossquito



18-022-18
 18 cm



18-022-21
 18 cm



18-023-18
 18 cm



18-023-22
 18 cm



18-024-18
 21 cm



18-024-21
 21 cm



18-025-18
 21 cm



18-025-21
 21 cm

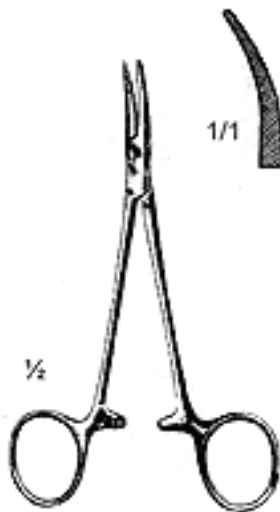

18-026-12
 12 cm

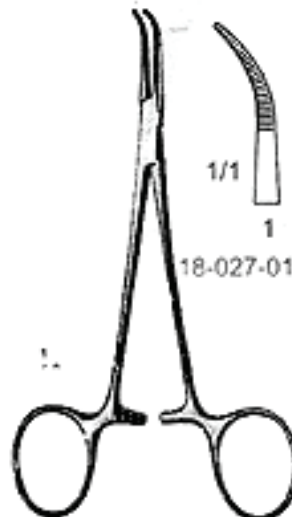

1-2
 18-027-14
 14 cm
 Baby-Mixer

ARTERY FORCEPS
ARTERIENKLEMMEN
PINZAS HEMOSTATICAS

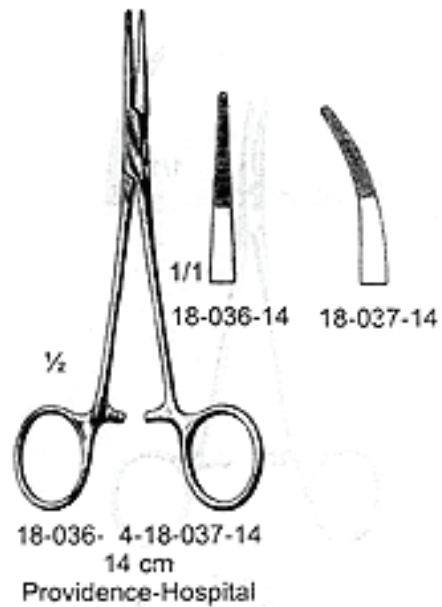
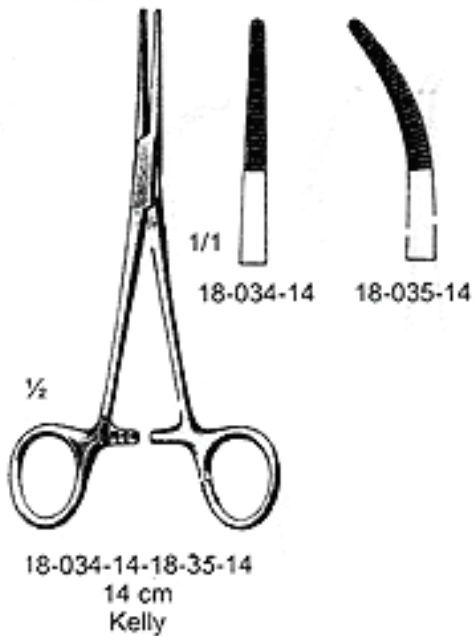
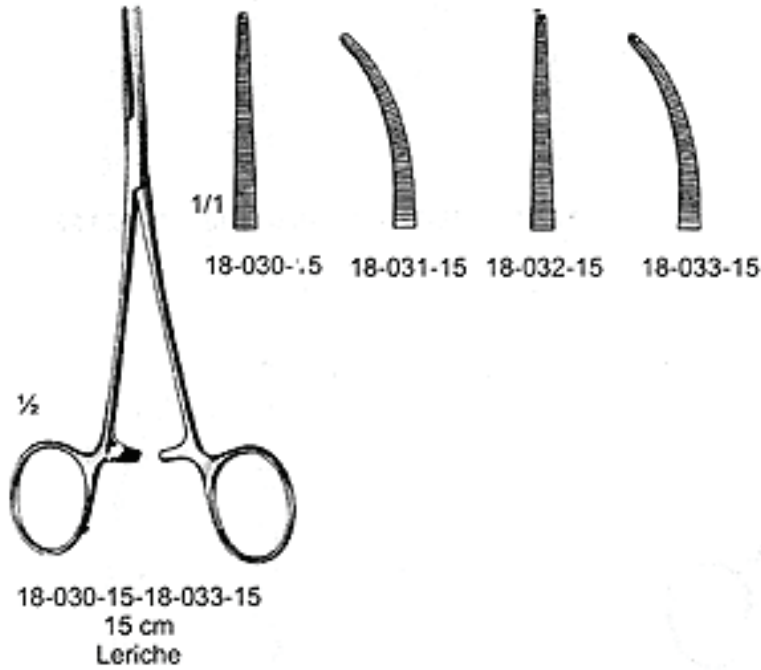



18-038-14-18-041-14
 14 cm
 Crile

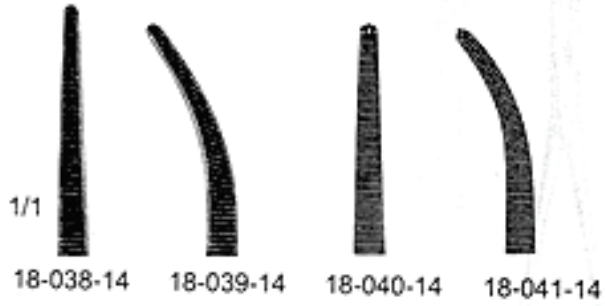

18-042-16-18-043-16
 16 cm
 Kelly-Rankin

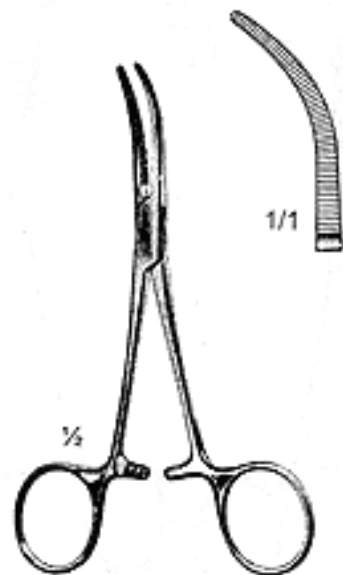
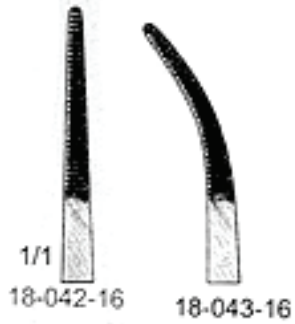

18-044-13
 13.5 cm
 Baby-Overholt



ARTERY FORCEPS
ARTERIENKLEMMEN
PINZAS HEMOSTATICAS

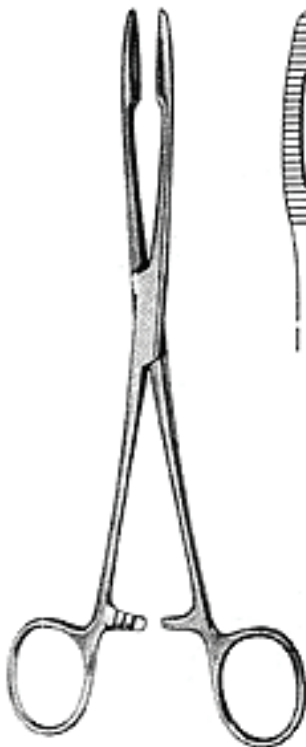
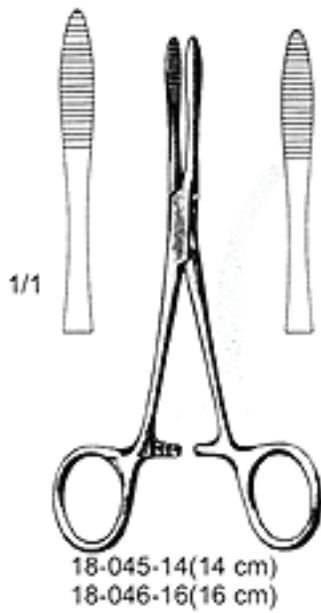
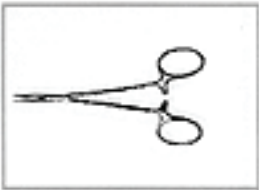

18-047-20
20 cm

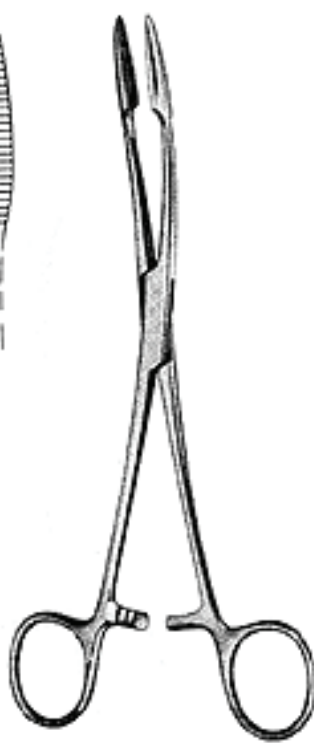

18-048-20
20 cm

Gross

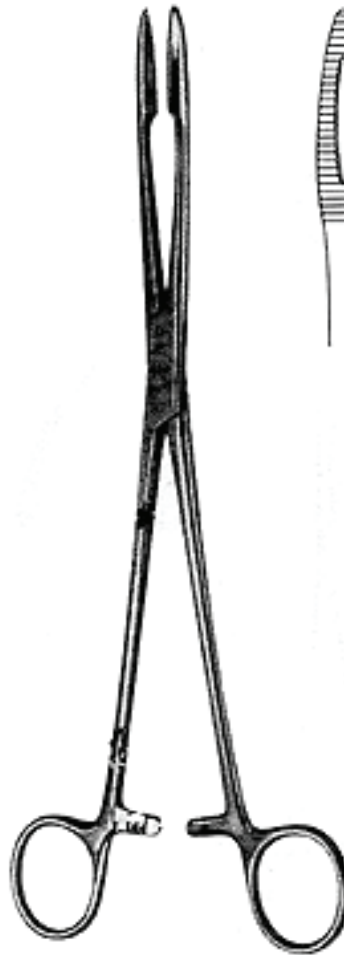

18-049-26
26 cm

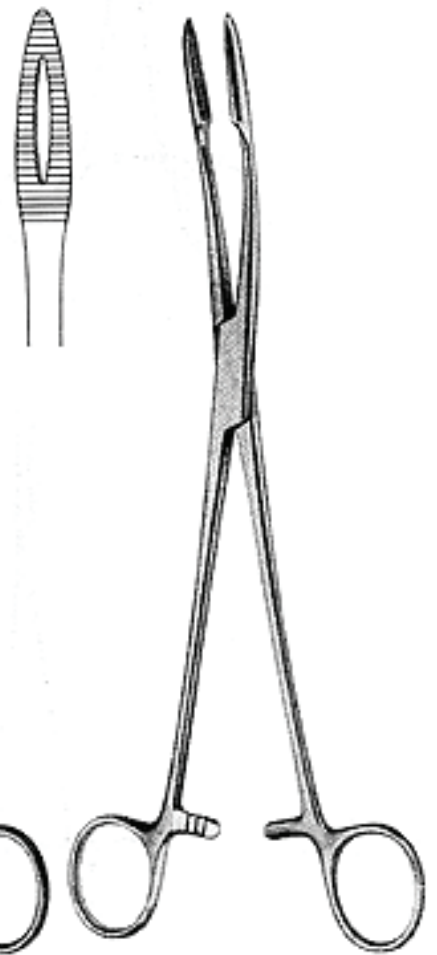

18-050-26
26 cm

Maier



18-051-05
5.5 cm



18-052-08
8 cm
Jones



18-053-18
18 cm
Schaedel



18-054-08
8 cm



18-055-13(13 cm)
18-055-15(15cm)
Roeder

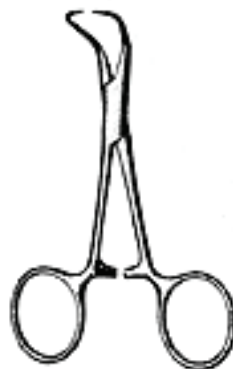

18-056-08(8.5 cm)
18-056-10(10 cm)



18-057-13(13 cm)
18-057-15(15 cm)

Backhaus

Department

19

NEEDLE HOLDERS
NADELHALTER
PORTA-AGUJAS

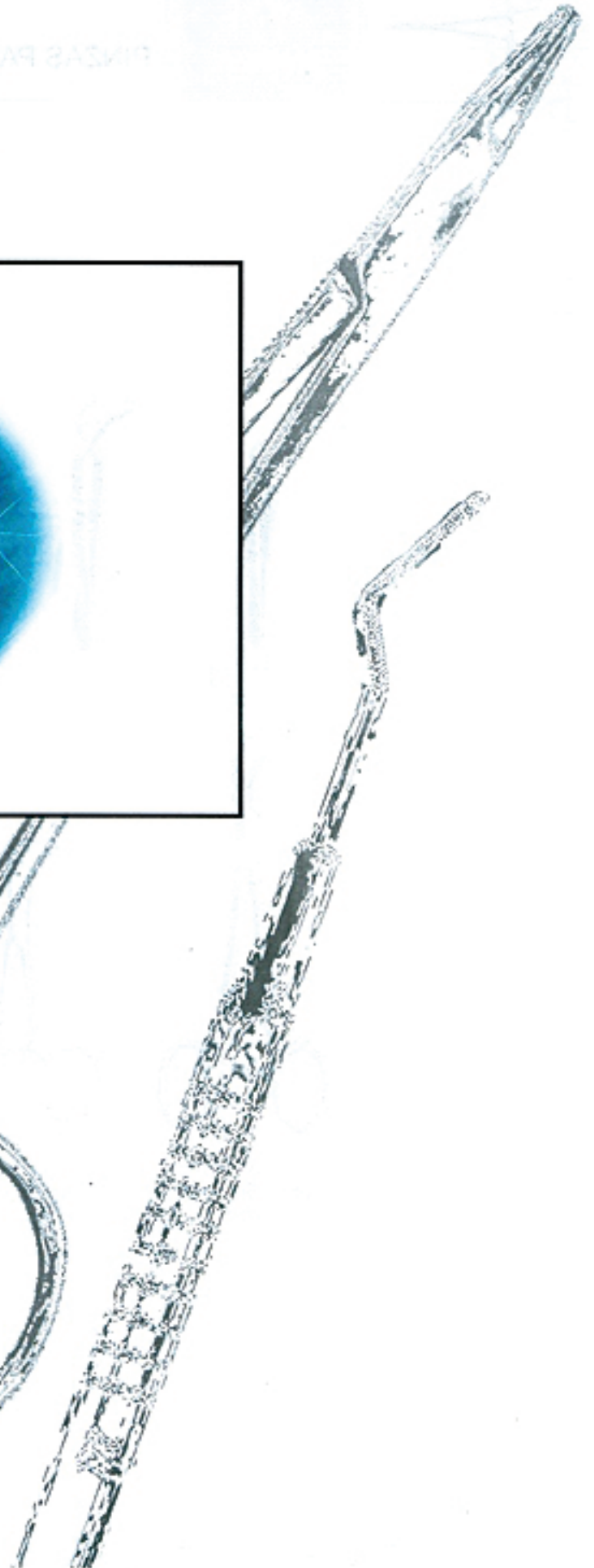
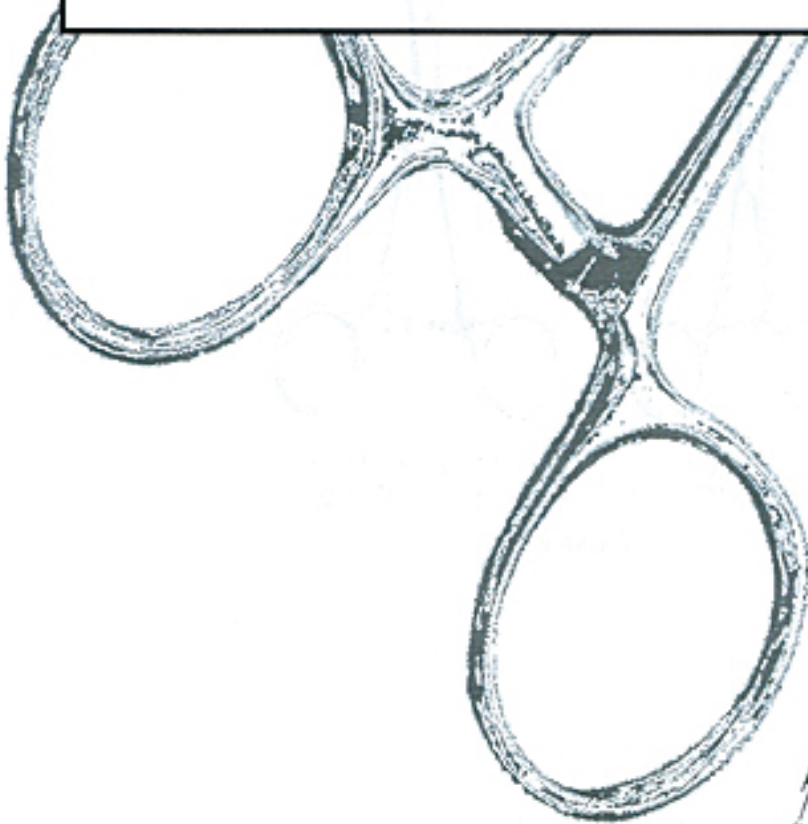
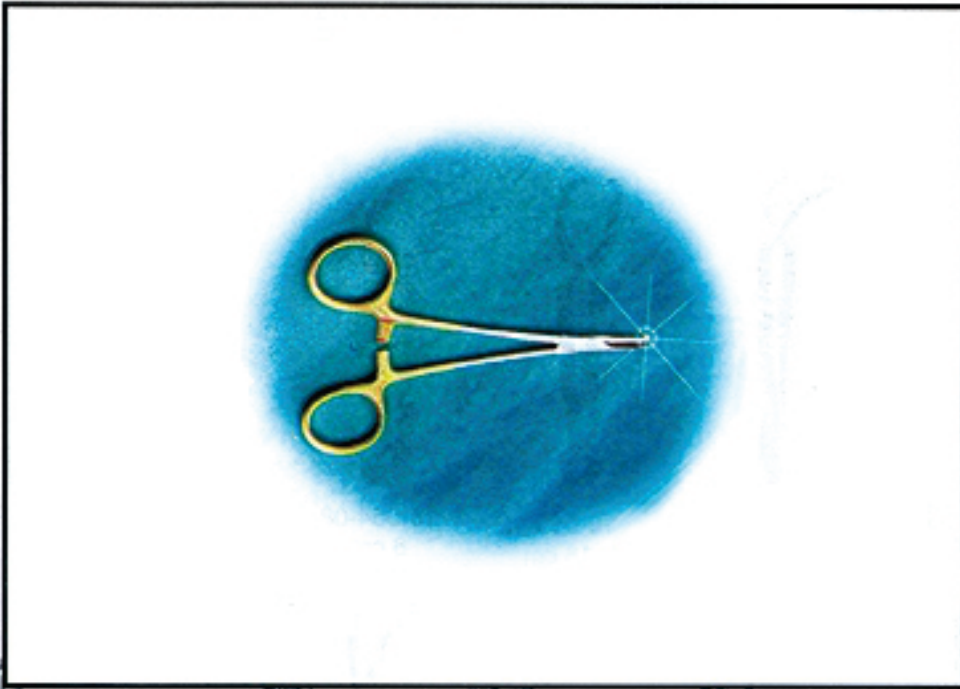

DEPARTMENT NO. 19

FROM
PAGE#

254

TO
PAGE#

265

INSTRUMENTS CATEGORY

NEEDLE HOLDERS
NADEL HOLDERS
PORTA-AGUJAS

NEEDLE HOLDERS NADEL HALTER PORTA-AGUJAS

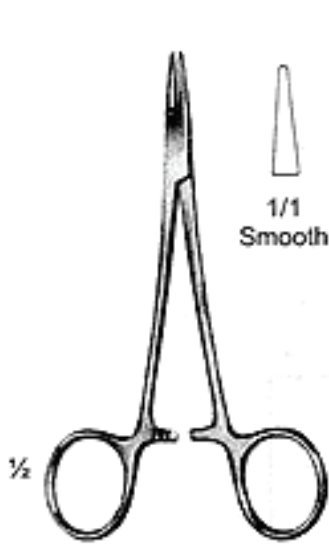

19-001-13
13 cm
Webster

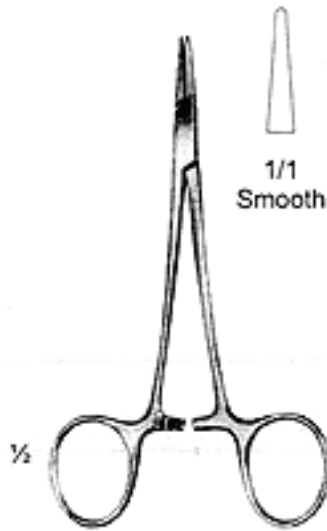

19-002-13
13 cm
Halsey

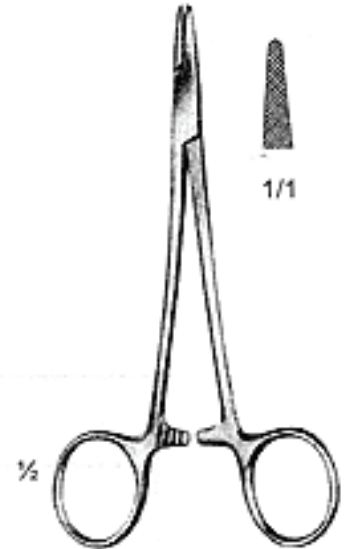

19-003-14
14 cm
Heger-Baumgartner

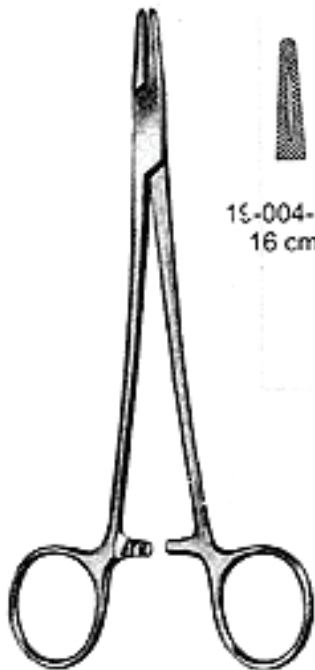

19-004-00

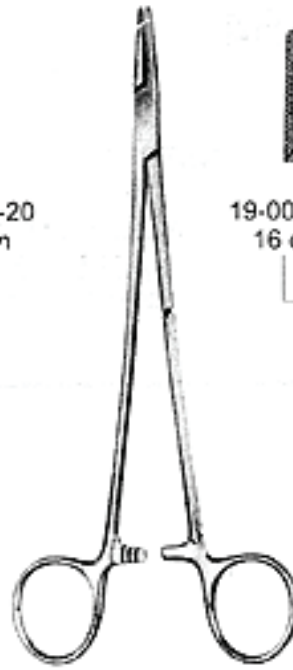

19-005-00



Delicate Patterns

Mayo-Hegar



19-007-18
 18 cm
 Toennis



19-008-16
 16 cm
 Langenbeck

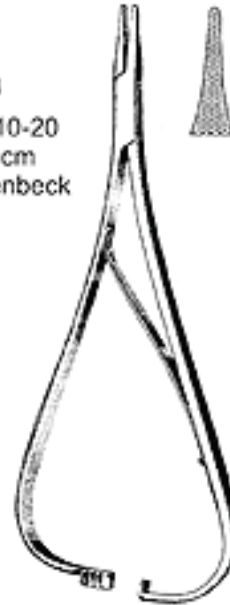
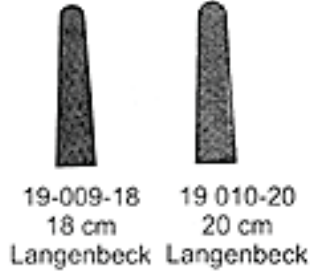

19-011-14(14 cm)
 19-012-17(17cm)
 Mathieu



19-013-12
 12 cm



19-014-12
 12 cm

Boynton

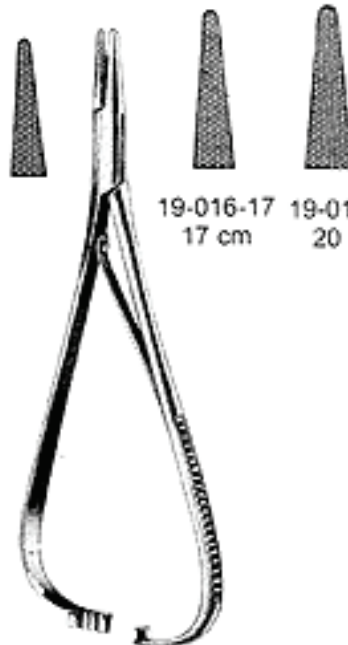

19-015-14
 14 cm
 Mathieu

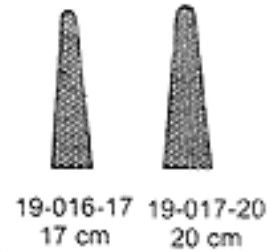

NEEDLE HOLDERS
NADEL HALTER
PORTA-AGUJAS

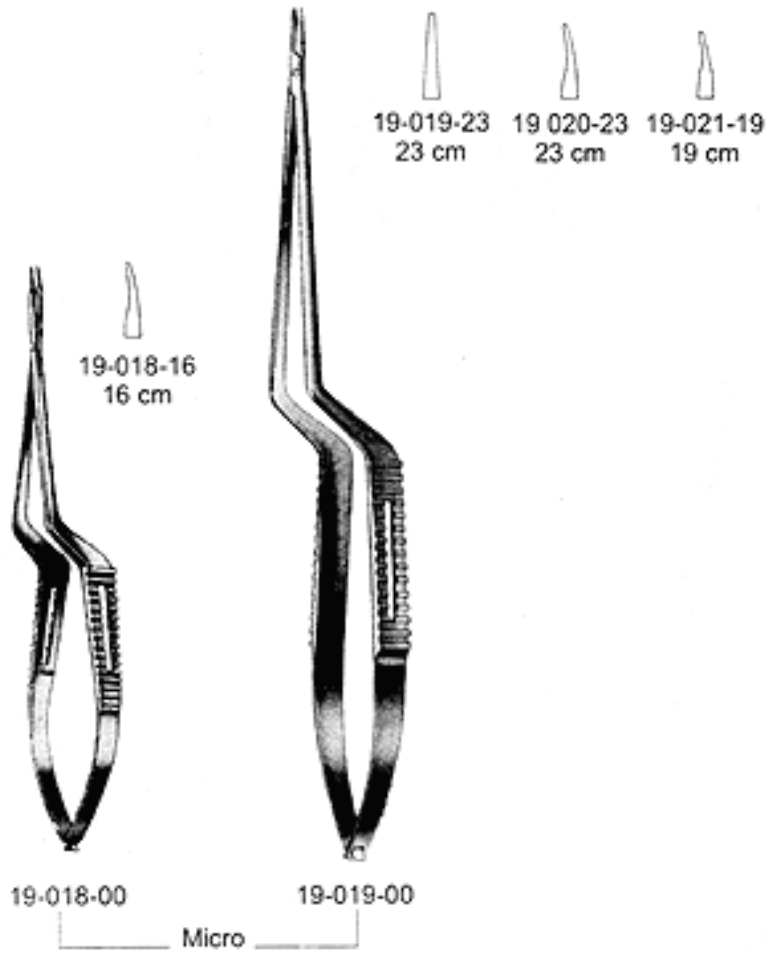



**TUNGSTEN
 CARBIDE
 INSERTS**



19-076-16
 16 cm

19-076-16
 16 cm
 Arruga



19-077-16
 16 cm



19-078-12
 12 cm
 Boyton



19-079-14(14 cm)
 19-079-17(17 cm)
 19-079-20(20 cm)
 19-079-24(24 cm)
 Mathieu



19-080-00
 Langenbeck, Leicht



19-081-16
 16 cm



19-082-18
 18 cm



19-083-20
 20 cm



19-084-22
 22 cm



19-085-25
 25 cm



19-086-17
 17 cm
 Lichtenberg

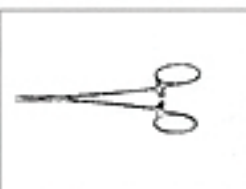

TUNGSTEN CARBIDE INSERTS

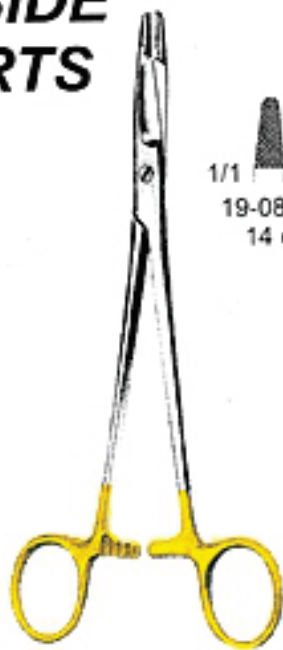

19-087-00
Olsen-Heger

- | | | | | | |
|-----|---|-----|---|-----|---|
| 1/1 |  | 1/1 |  | 1/1 |  |
| | 19-087-14 | | 19-087-16 | | 19-088-18 |
| | 14 cm | | 16.5 cm | | 18 cm |

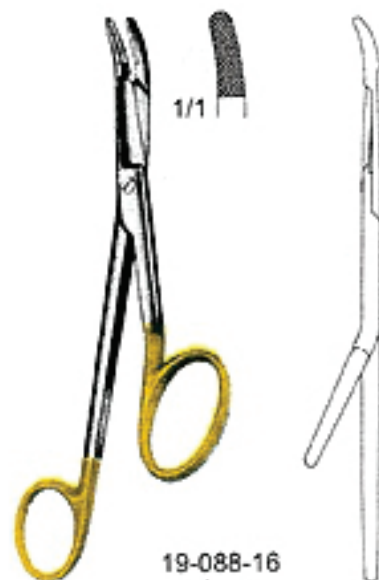

19-088-16
16 cm
Gillies



19-089-15
15 cm

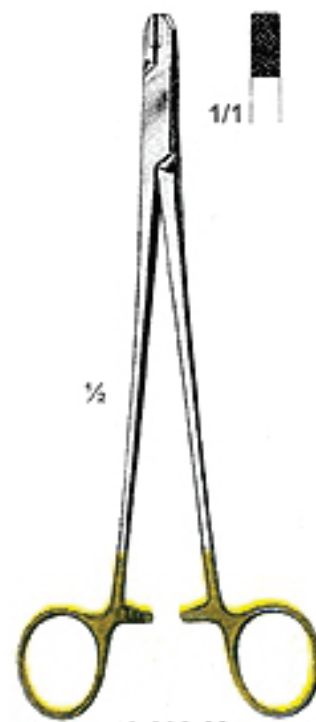

19-090-20
20 cm



TUNGSTEN CARBIDE INSERTS



19-091-13
 13 cm
 Halsey

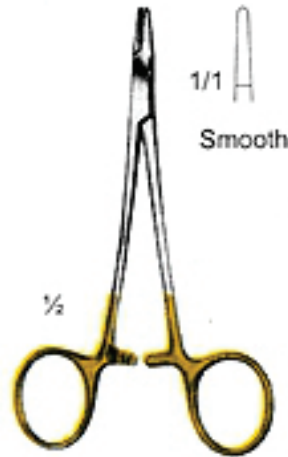

19-093-12
 12 cm
 Webster



19-094-15
 15 cm
 Crile Wood

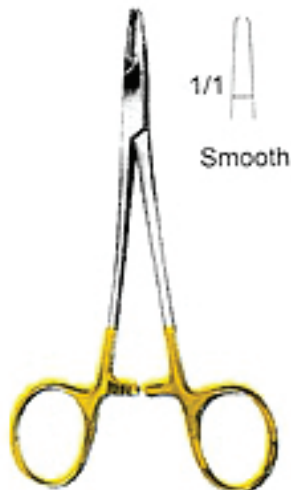

19-095-13
 13 cm
 Webster



19-096-12
 12 cm
 Derf



19-097-00
 Hegar-Baumgartner



TUNGSTEN CARBIDE INSERTS

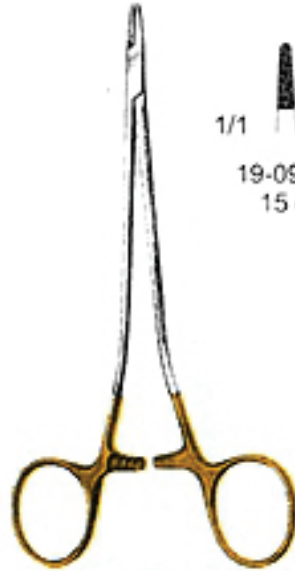

19-098-00
Martin

- 1/1 19-098-15 15 cm
- 19-098-17 17 cm
- 19-098-20 20 cm

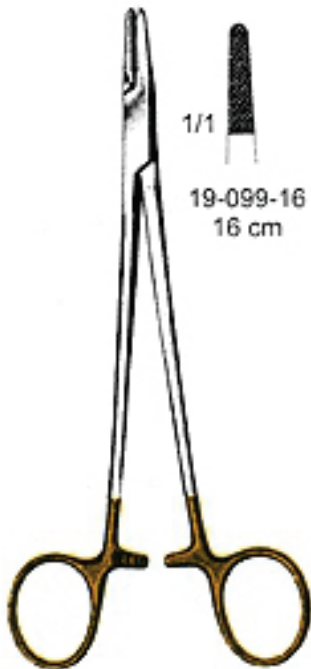

19-099-00
Mayo-Hegar

- 1/1 19-099-16 16 cm
- 19-099-18 18 cm
- 19-099-20 20 cm

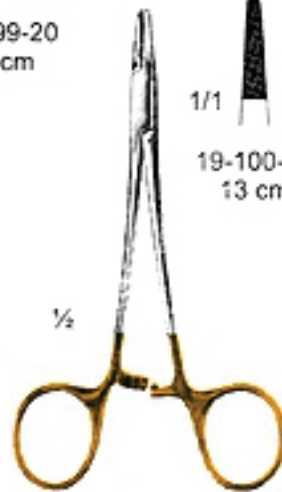

19-100-00
Universal

- 1/1 19-100-13 13 cm
- 19-100-15 15 cm

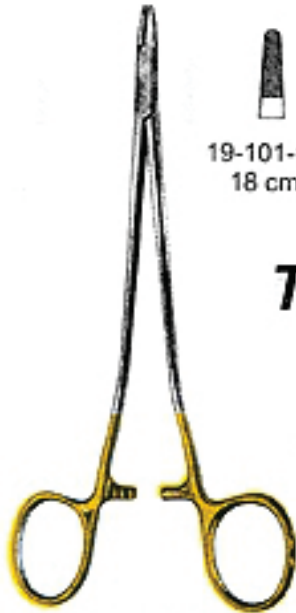

19-101-00
 Sarot



**TUNGSTEN
 CARBIDE
 INSERTS**



19-104-00
 Mayo Heger

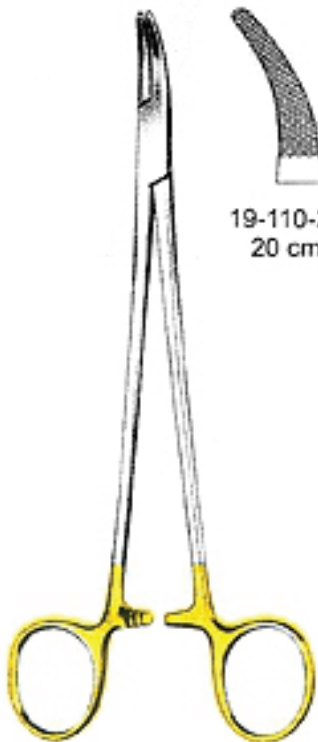
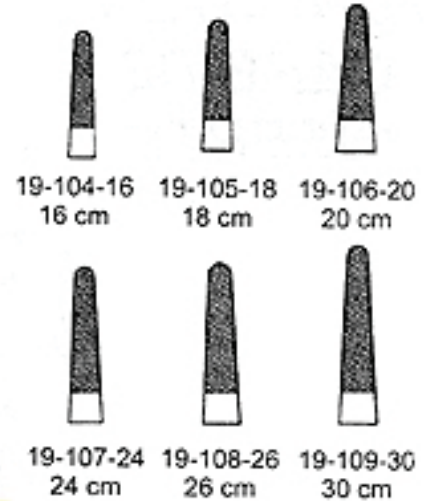

19-110-00
 Mayo Heger (Heaney)

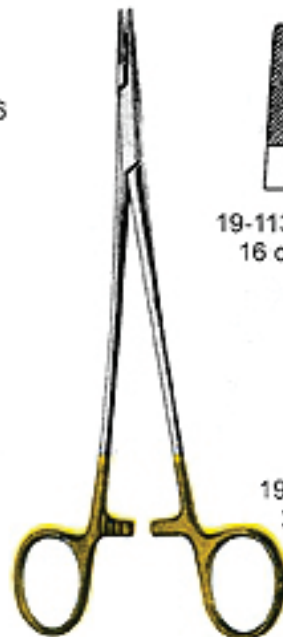
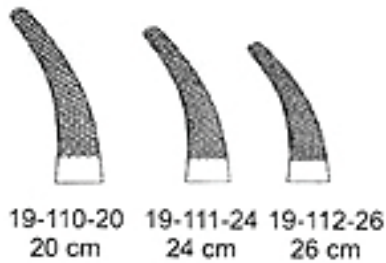

19-113-00
 De Bakey

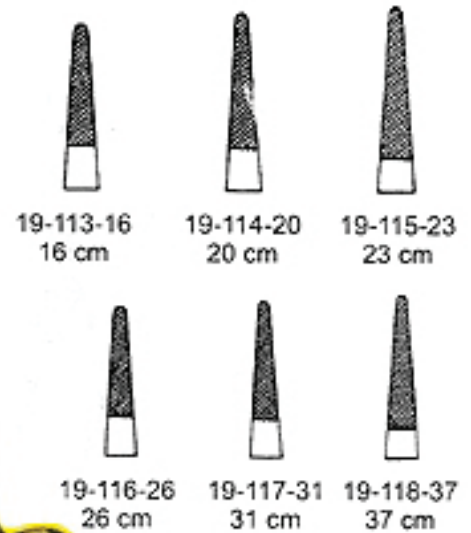



TUNGSTEN CARBIDE INSERTS



19-114-00
Vascular



19-118-00
Dietrich

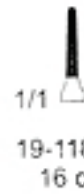

19-123-00



19-127-18
18 cm
Scheidel

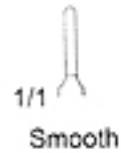

19-128-22
22 cm
Pott-Smith



- 1- Probe double end
- 2- Grooved director with tongue tie
- 3- B.P. Handle No.3
- 4- B.P. Handle No.4
- 5- Thum dressing forcep serrated 14 cm
- 6- Tissue forcep 14 cm, 1x2 teeth
- 7- Mayo hegar needle holder 14 cm
- 8- Operating scissor 14 cm SH/BL str
- 9- Operating scissor 14 cm SH/BL cvd

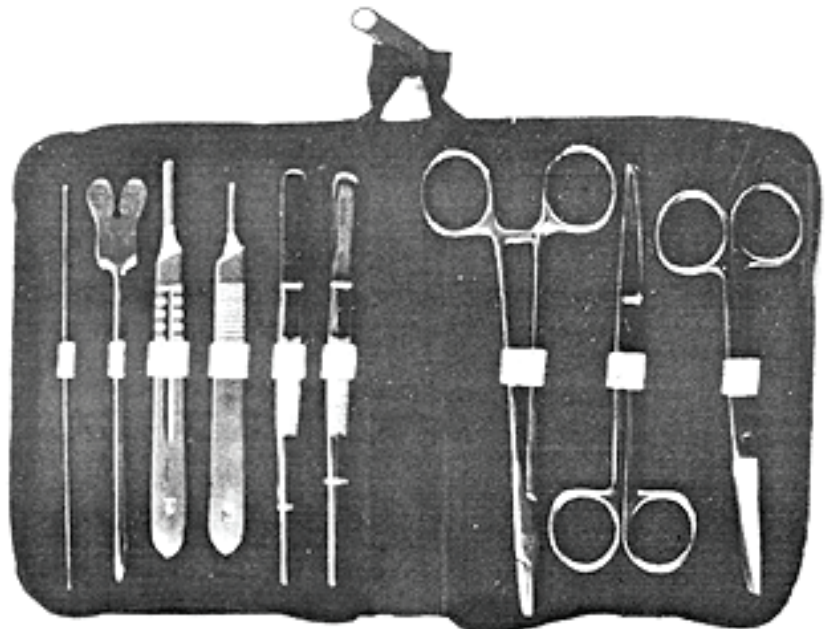

19-134-00
Dissecting set consisting of 9 instruments

- 1- Probe double end
- 2- Grooved director with tongue tie
- 3- B.P. Handle No.3
- 4- B.P. Handle No.4
- 5- Thum dressing forcep serrated 14 cm
- 6- Tissue forcep 14 cm, 1x2 teeth
- 7- Mayo hegar needle holder 14 cm
- 8- Operating scissor 14 cm SH/BL str
- 9- Operating scissor 14 cm SH/BL cvd
- 10- Kelly Forcep 14 cm Str.
- 11- Kelly Forcep 14 cm Cvd.

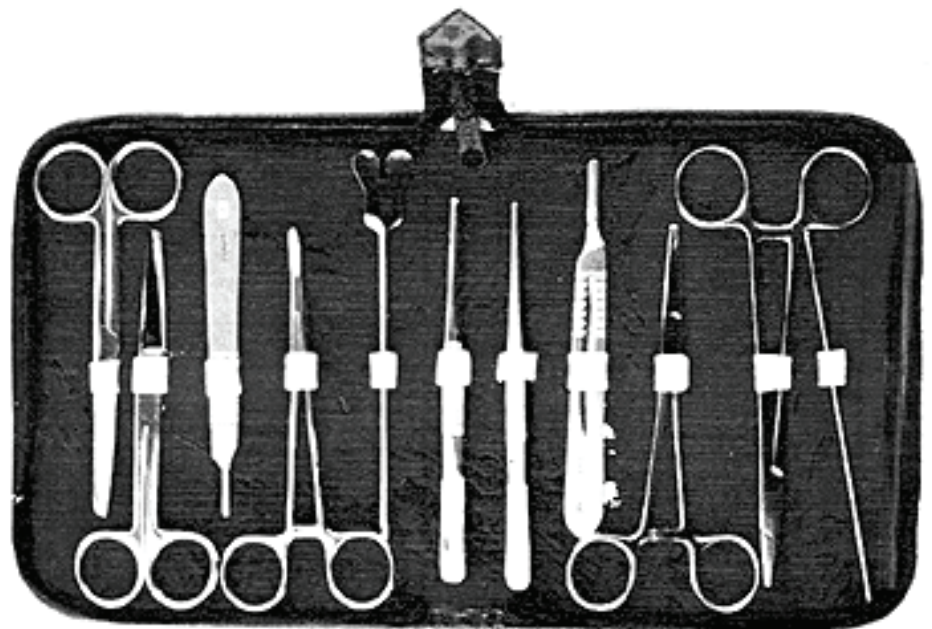

19-134-00
Dissecting set consisting of 11 instruments

Department

20

INSTRUMENTS BOXES
INSTRUMENTENBEHALTER
CONTENEDORES PARA INSTRUMENTOS

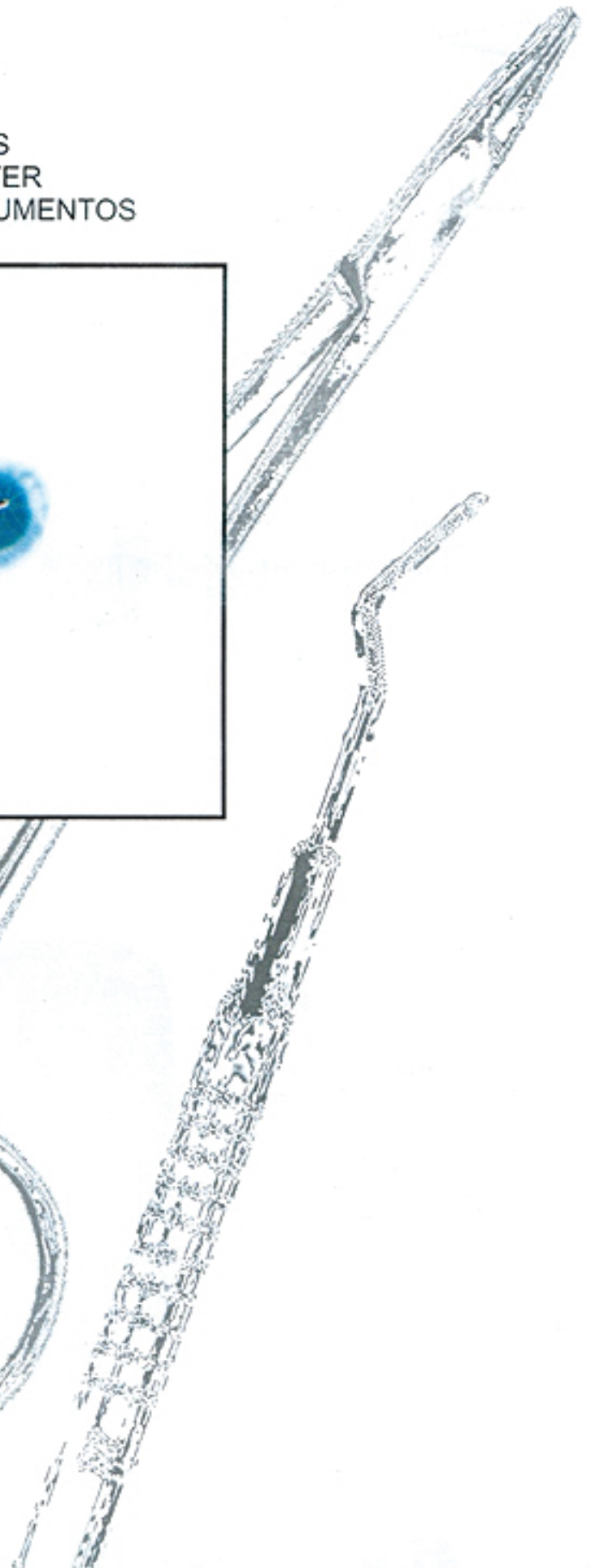
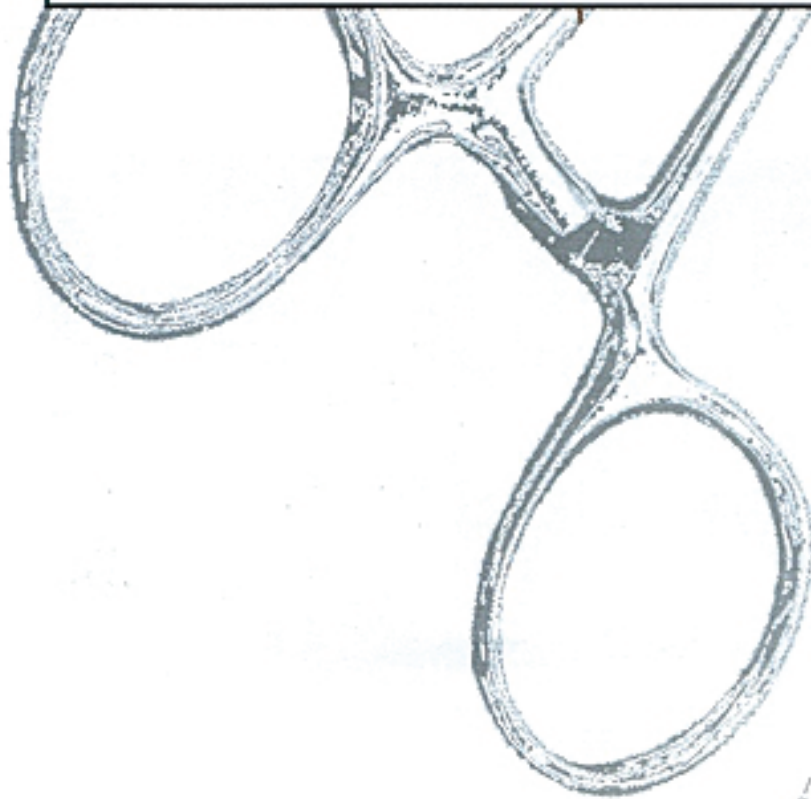
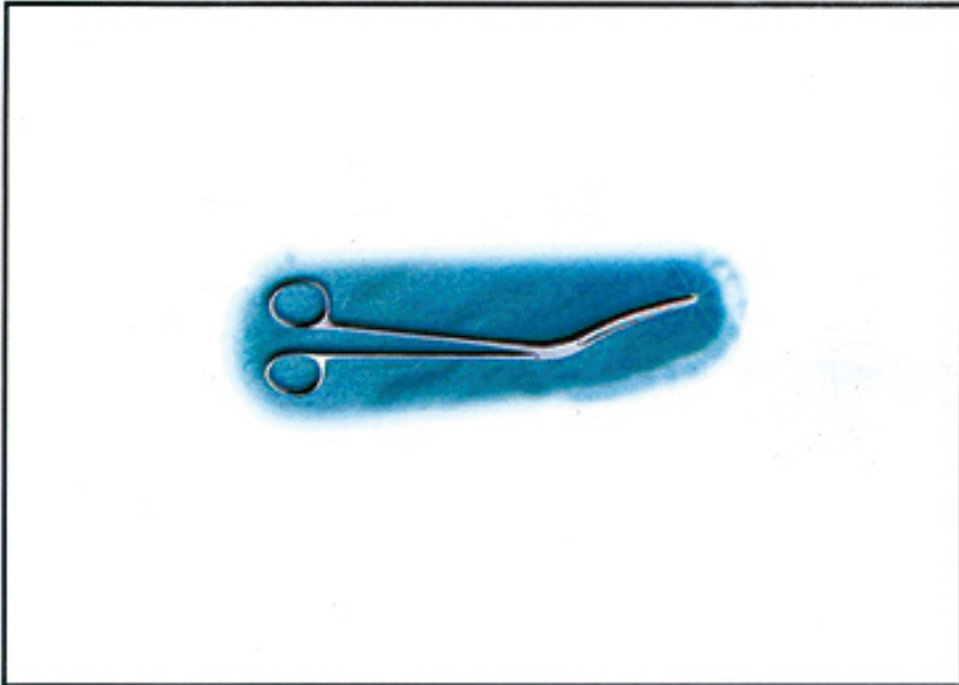

DEPARTMENT NO. 20

FROM
PAGE#

266

TO
PAGE#

272

INSTRUMENTS CATEGORY

INSTRUMENTS BOXES
INSTRUMENTENBEHALTER
CONTENEDORES PARA INSTRUMENTOS

STERILIZER FORCEPS
 STERILISIERZANGEN
 PINZAS PARA ESTERLIZAR

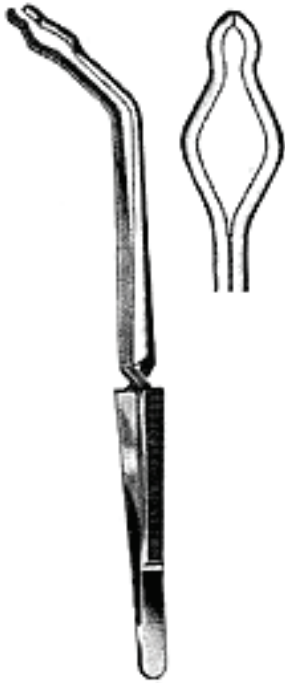

20-001-18(18 cm)
 20-002-25(25 cm)
 Mod . Martin



20-003-16(16 cm)
 20-004-20(20 cm)
 20-005-24(24 cm)
 Davis



20-006-25(25 cm)
 20-007-30(30 cm)
 Pye-Smith
 (Harrison)



20-008-23
 23 cm
 Rogge



20-009-20(20 cm)
 20-010-30(30 cm)



20-011-27
 27 cm
 Cheatle

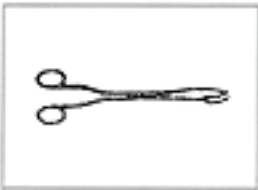

20-012-24
24 CM



20-013-24
24 CM
Ulival



20-014-20(20 cm)
20-015-28(28 cm)



20-016-20(20 cm)
20-017-28(28 cm)

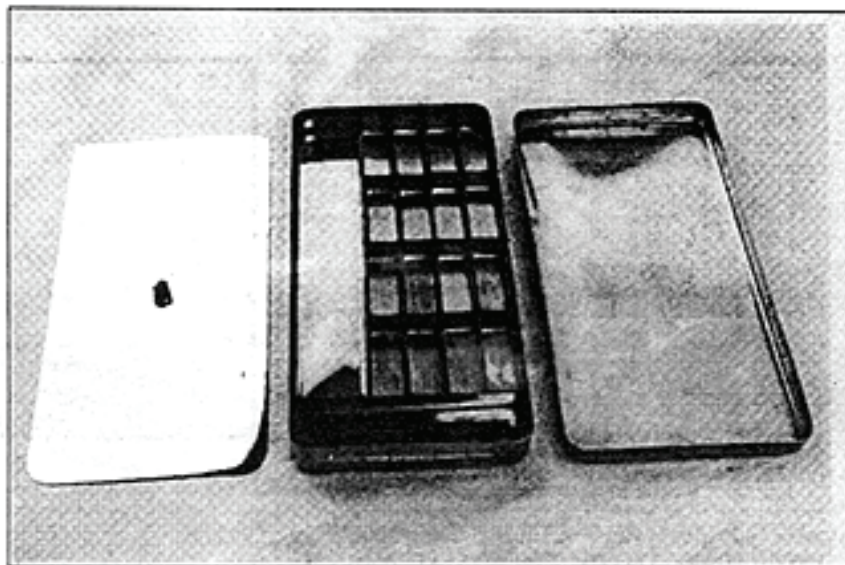

20-018-00
Endodontics Try
Curettage Case Double Cap

INSTRUMENTS BOXES
 INSTRUMENTENBEHALTER
 CONTENEDORES PARA INSTRUMENTOS



L	W	H
20-066-00	17x7x3 cm	
20-067-00	17.5x7.5x3 cm	
20-068-00	18x6x3 cm	
20-069-00	18x7x3 cm	
20-070-00	18x9x4 cm	
20-071-00	20x10x4 cm	
20-072-00	21x10x4 cm	

Instrument Boxes
 In Different Sizes.

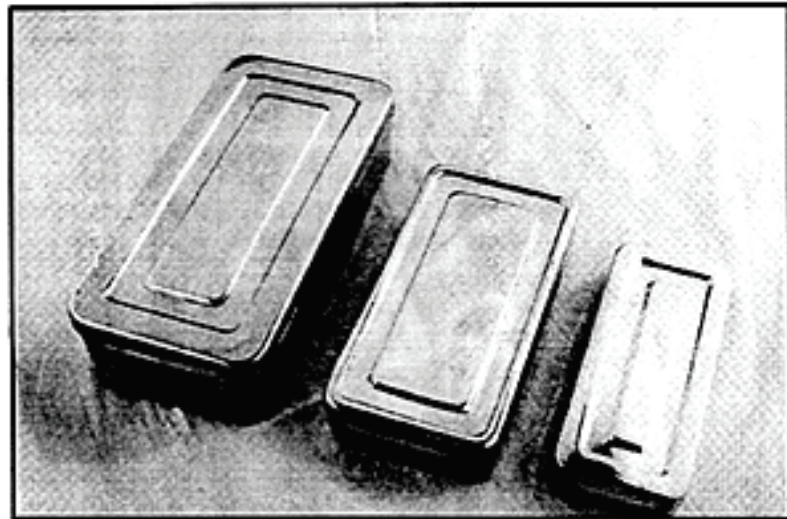

20-073-00
 Needle Case

20-074-00(5 cc)
 20-075-00(2 cc)
 Syringe Case



20-076-0
 Finger Cup

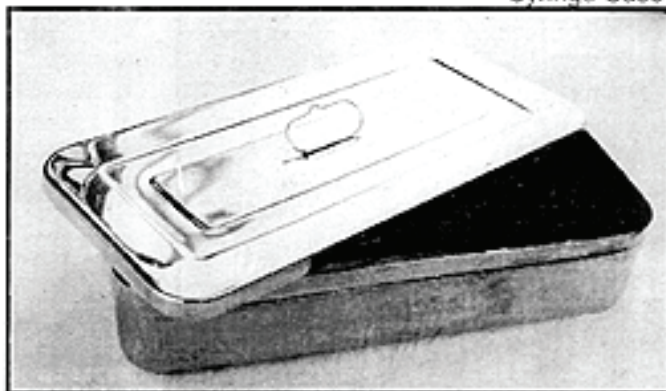

L	W	H	L	W	H
20-077-00	30x15x10 cm		20-083-00	40x20x10 cm	
20-078-00	30x17x5 cm		20-084-00	40x30x5 cm	
20-079-00	34x16x5 cm		20-085-00	40x30x10 cm	
20-080-00	36x24x5 cm		20-086-00	42x19x5 cm	
20-081-00	36x24x10 cm		20-087-00	45x30x5 cm	
20-082-00	40x20x5 cm		20-088-00	45x30x10 cm	

Instrument Boxes
 In Different Sizes.

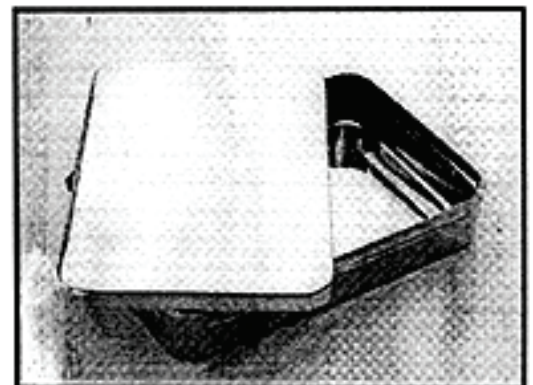

L	W	H
20-089-00	23x15x5 cm	
20-090-00	25x12x5 cm	
20-091-00	25x12x10 cm	
20-092-00	26x15x5 cm	
20-093-00	30x15x5 cm	
20-094-00	32x8x4 cm	

Instrument Boxes
 In Different Sizes.

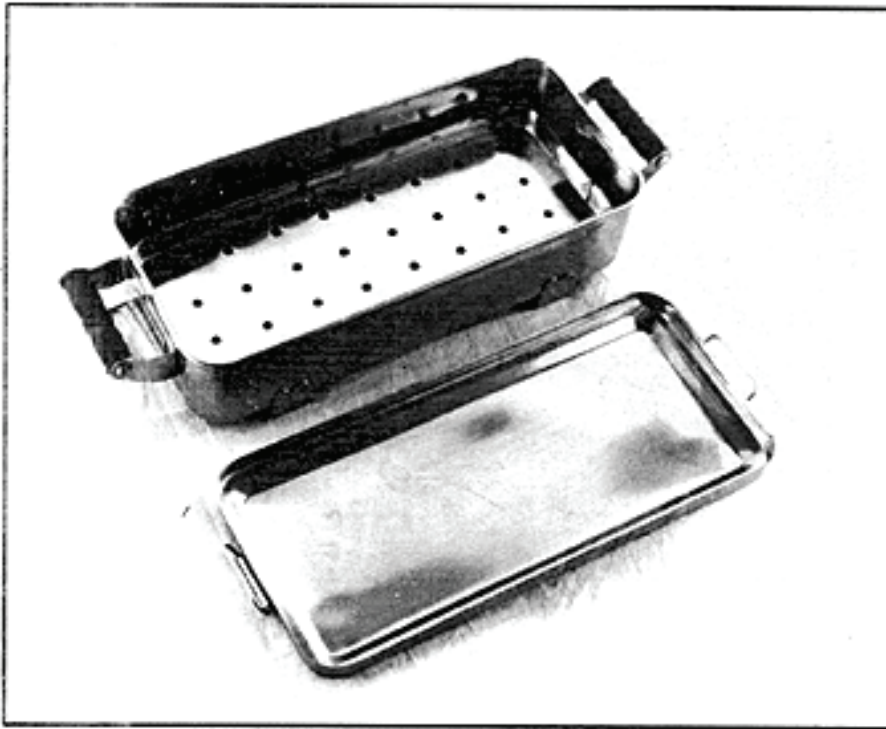

20-095-00(27x12x6 cm)
Sterilizer With Heater



- | | |
|----------------------|----------------------|
| 20-096-00 (24x12 cm) | 20-101-00 (34x28 cm) |
| 20-097-00 (30x15 cm) | 20-102-00 (37x30 cm) |
| 20-098-00 (30x30 cm) | 20-103-00 (39x14 cm) |
| 20-099-00 (34x16 cm) | 20-104-00 (39x20 cm) |
| 20-100-00 (34x24 cm) | 20-105-00 (39x29 cm) |

Dressing/Sterilizing Drum
In Different Sizes.

- | |
|----------------------|
| 20-106-00 (8x8 cm) |
| 20-107-00 (10x10 cm) |
| 20-108-00 (12x12 cm) |
| 20-109-00 (15x15 cm) |
| 20-110-00 (16x12 cm) |
| 20-111-00 (18x18 cm) |
| 20-112-00 (19x14 cm) |
| 20-113-00 (19x20 cm) |
| 20-114-00 (20x16 cm) |
| 20-115-00 (20x20 cm) |
| 20-116-00 (24x16 cm) |
| 20-117-00 (24x24 cm) |
| 20-118-00 (29x14 cm) |
| 20-119-00 (29x16 cm) |
| 20-120-00 (29x24 cm) |

Dressing/Sterilizing Drum
In different sizes.

STERILIZING, DRESSING JAR & FORCEPS
 STERILISING, PRAPARIERBEHALTER, ZANGENBEHALTER
 CAJA PARA ESTERILIZACION Y PREPARACION CAJA PARA PINZAS

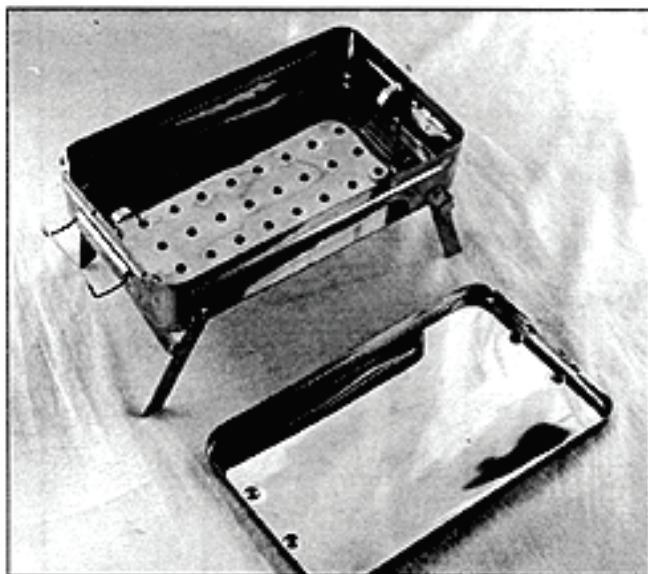

- 20-121-00 (20x10x5 cm)
- 20-122-00 (25x12x5 cm)
- 20-123-00 (26x15x5 cm)

Boiling Sterilizer With Perforated Tray Stand And Lifter.



- 20-124-00 (7.5x7.5 cm)
- 20-125-00 (10x10 cm)
- 20-126-00 (12.5x12.5 cm)
- 20-127-00 (15x15 cm)
- 20-128-00 (18x18 cm)
- 20-129-00 (10x12.5 cm)
- 20-130-00 (20x20 cm)

Cotton/Dressing Jar With Lid. Consisting of Different Sizes.

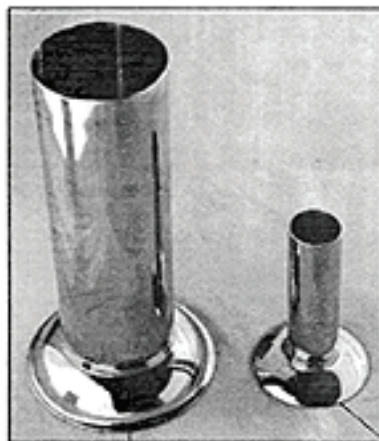

- 20-131-00 (5x11.5 cm)
- 20-132-00 (5x16.5 cm)

- 20-133-00(3x11 cm)
- 20-133-00

Forcep Jar/Cheate Jar Consisting Of Different Sizes.

Department

21

RUBBER DAM INSTRUMENTS
KOFFERDAM - INSTRUMENTE
INSTRUMENTOS PARA DIQUE DE GOMA

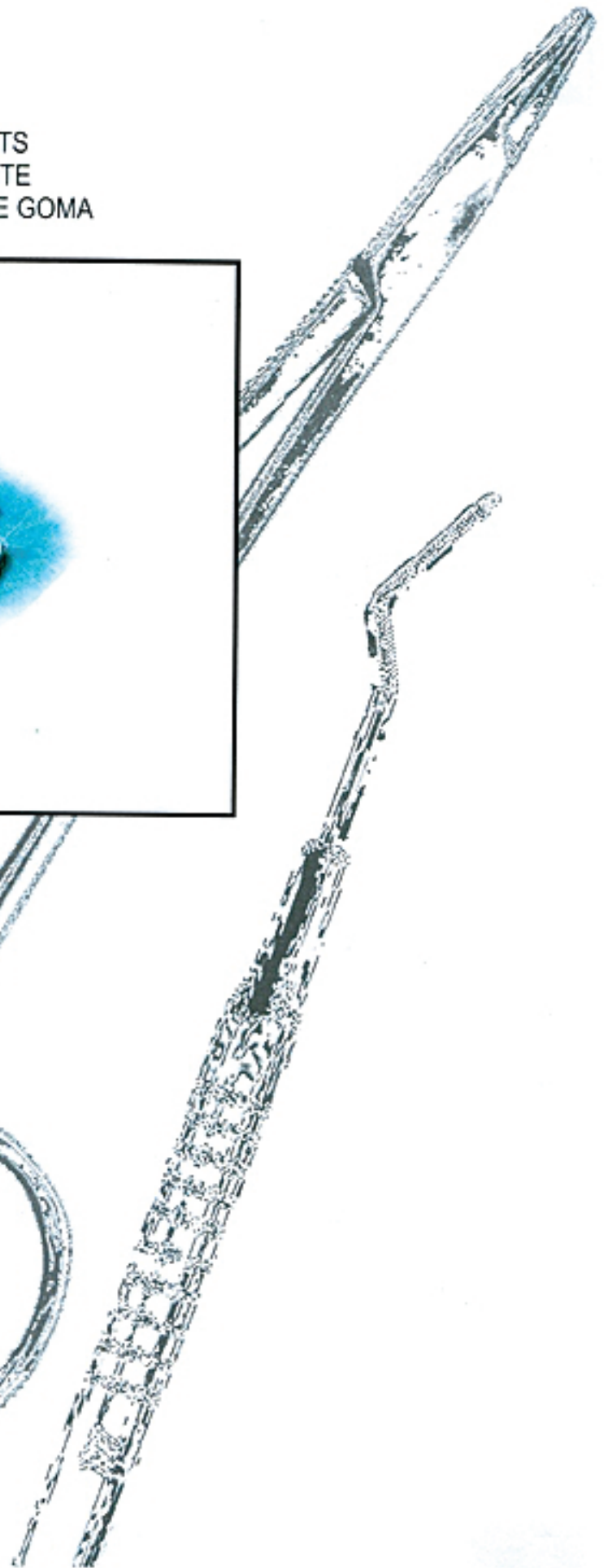
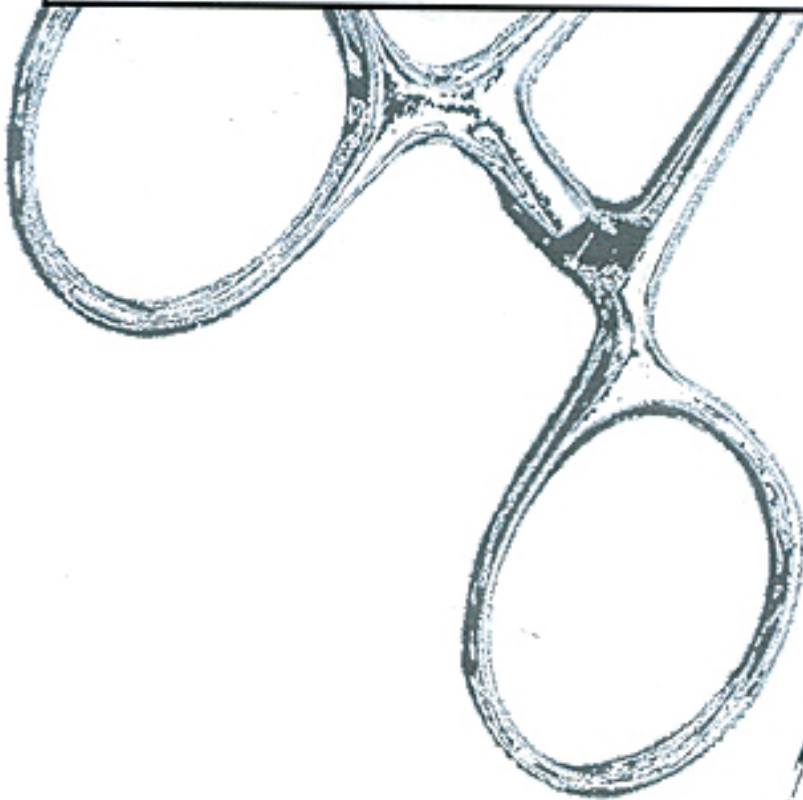
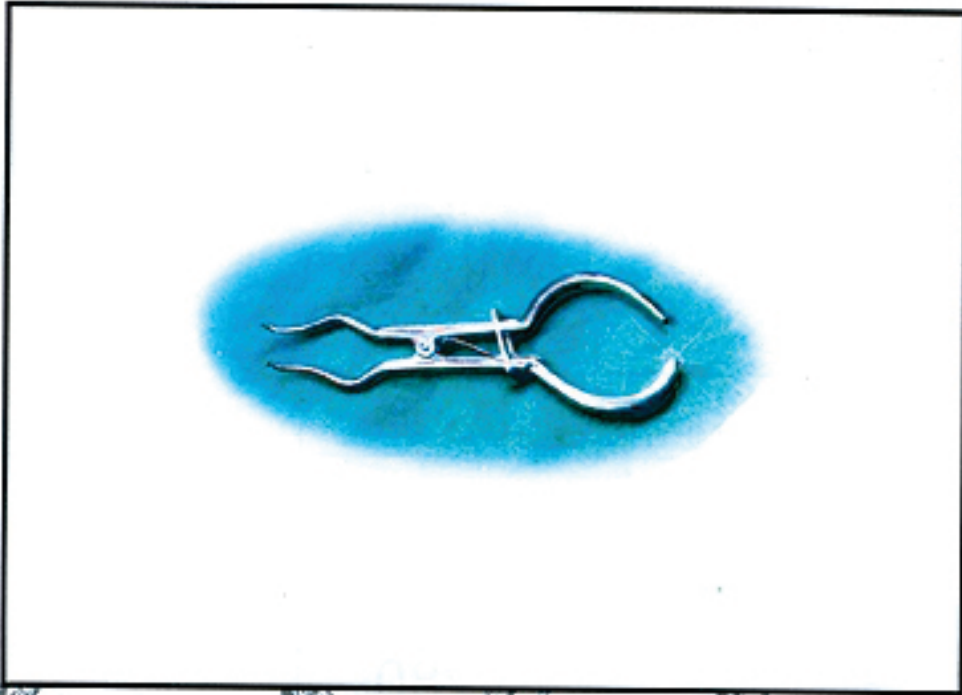

DEPARTMENT NO. 21

FROM
PAGE#

273

TO
PAGE#

280

INSTRUMENTS CATEGORY

RUBBER DAM INSTRUMENTS
KOFFERDAM - INSTRUMENTE
INSTRUMENTOS PARA DIQUE DE GOMA

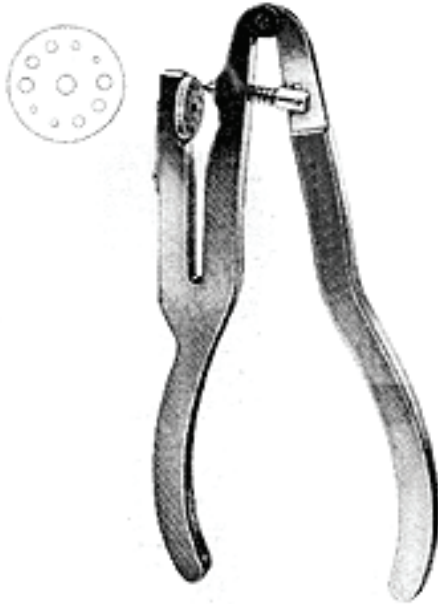

21-001-00
Ivory
With two rows of holes

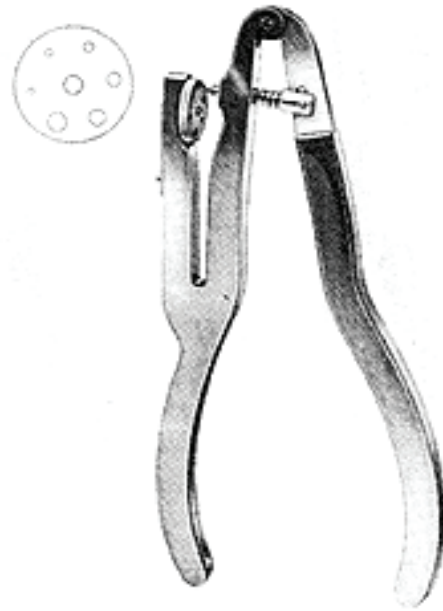

21-002-00
Ivory
With one rows of holes



21-003-00



21-004-00

Ainsworth



5
 21-005-00
 Ainsworth type rubber
 dam punch



21-006-00



21-007-00
 Light weight rubber
 dam punch



21-008-17
 17 cm
 Ainsworth

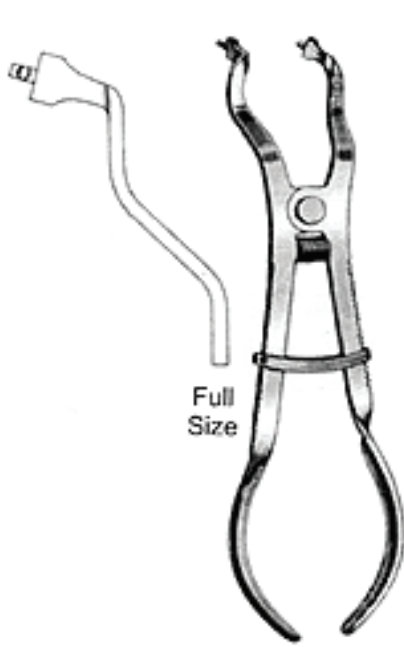
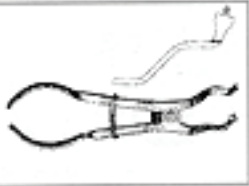

21-009-00
 Ivory

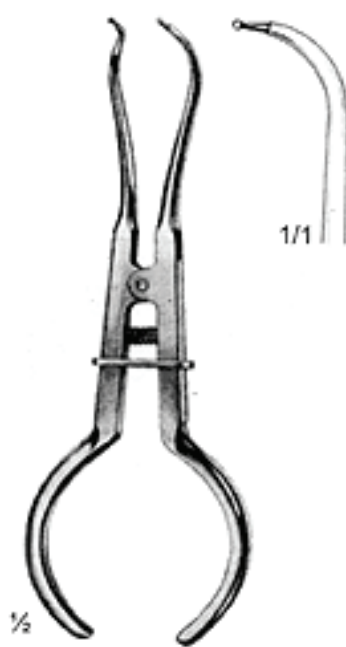

21-010-00
 White

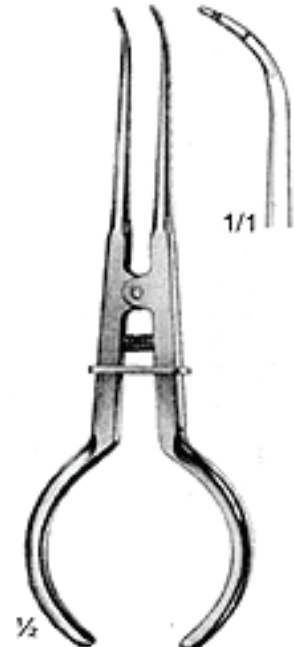

21-011-00
 Palmer

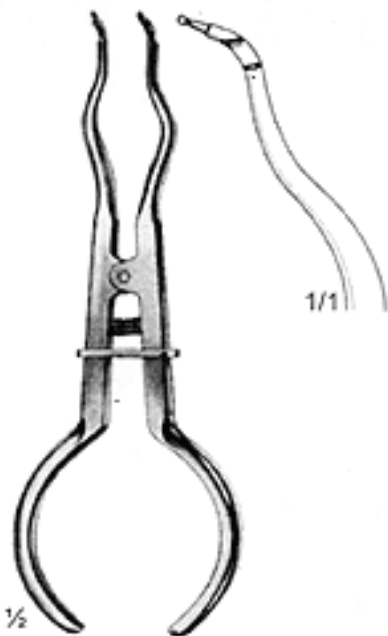

21-012-00
 Brewer

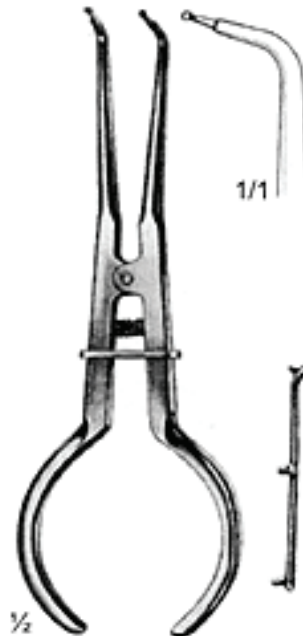

21-013-00
 Stockes



21-014-00 (Large)
 21-015-00 (Small)
 Rubber Dam Frame

RUBBER DAM CLAMPS
KOFFERDAM - CLAMMERNS
CLAMPS PARA DIQUE



201
21-016-00



202
21-017-00



203
21-018-00



204
21-019-00



205
21-020-00



3
21-021-00



4
21-022-00



5
21-023-00



8
21-024-00



8A
21-025-00



12A
21-026-00



13A
21-027-00



14
21-028-00



14A
21-029-00



200
21-030-00



24
21-031-00



25
21-032-00



26
21-033-00



28
21-034-00



30
21-035-00



51
21-036-00



138
21-037-00



139
21-038-00



31
21-039-00



W8A
21-040-00



W14
21-041-00



W14A
21-042-00



15
21-043-00



18
21-044-00

RUBBER DAM CLAMPS
KOFFERDAM - CLAMMERNS
CLAMPS PARA DIQUE



212
21-045-00



22
21-046-00



27
21-047-00



29
21-048-00



210
21-049-00



211
21-050-00



21-051-00



206
21-052-00



207
21-053-00



208
21-054-00



209
21-055-00



00
21-062-00



0
21-059-00



1
21-057-00



W2
21-058-00



W3
21-056-00



W13
21-063-00



2A
21-060-00



9
21-064-00



26N
21-061-00



2
21-065-00



7
21-066-00



7 A
21-067-00



12
21-068-00



17 N
21-069-00



56
21-070-00



60
21-071-00

Department

22

CROWN INSTRUMENTS
KRONENINSTRUMENTE
INSTRUMENTOS PARA CORONAS

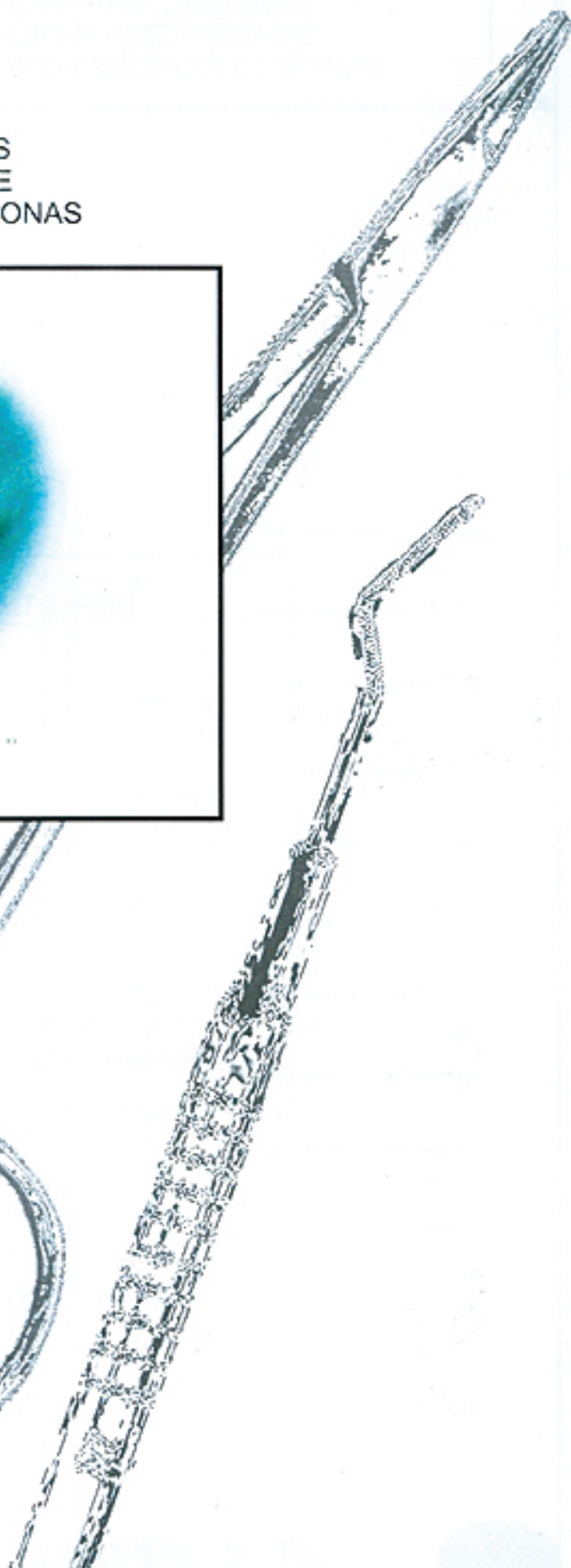
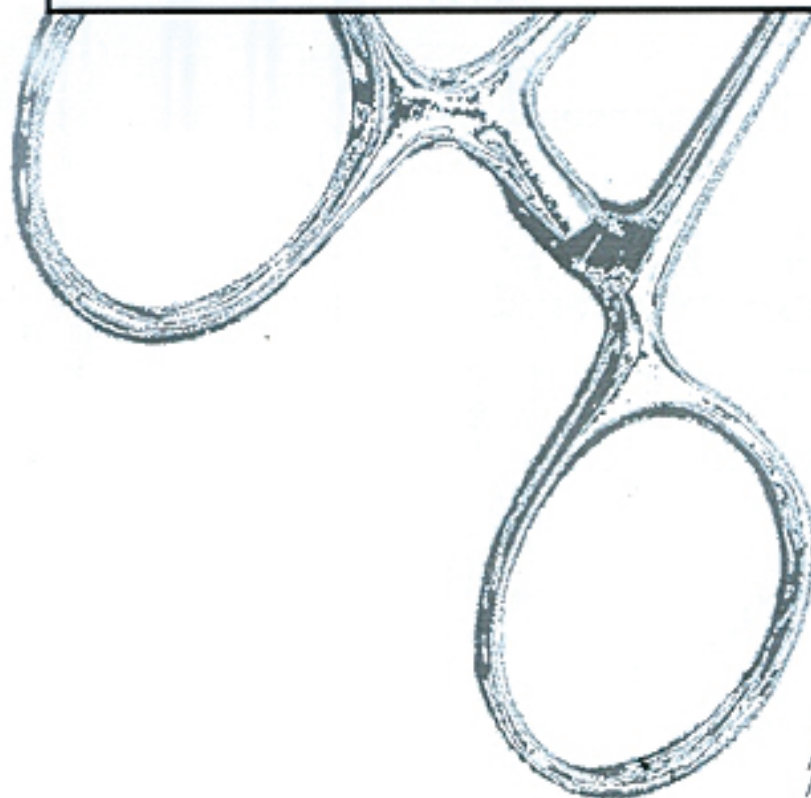
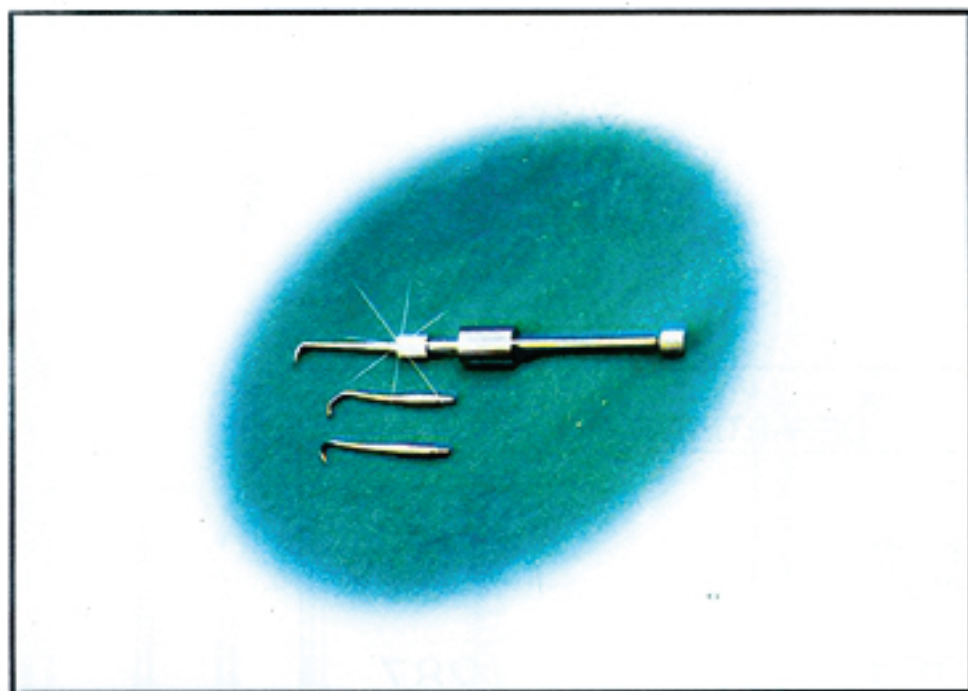

DEPARTMENT NO. 22

FROM
PAGE#

TO
PAGE#

281

287

INSTRUMENTS CATEGORY

CROWN INSTRUMENTS
KRONENINSTRUMENTE
INSTRUMENTOS PARA CORONAS



1-3
 22-001-00

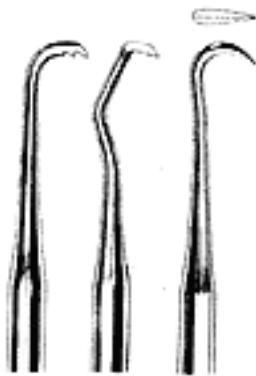

1 2 3
 22-001-01 22-001-02 22-001-03



1-3
 22-002-00



0-9
 22-003-00

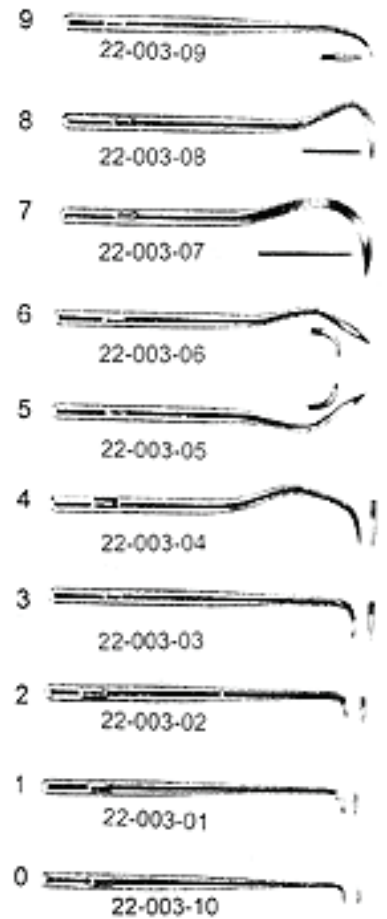

CROWN INSTRUMENTS
KRONEN INSTRUMENTE
INSTRUMENTOS PARA CORONAS

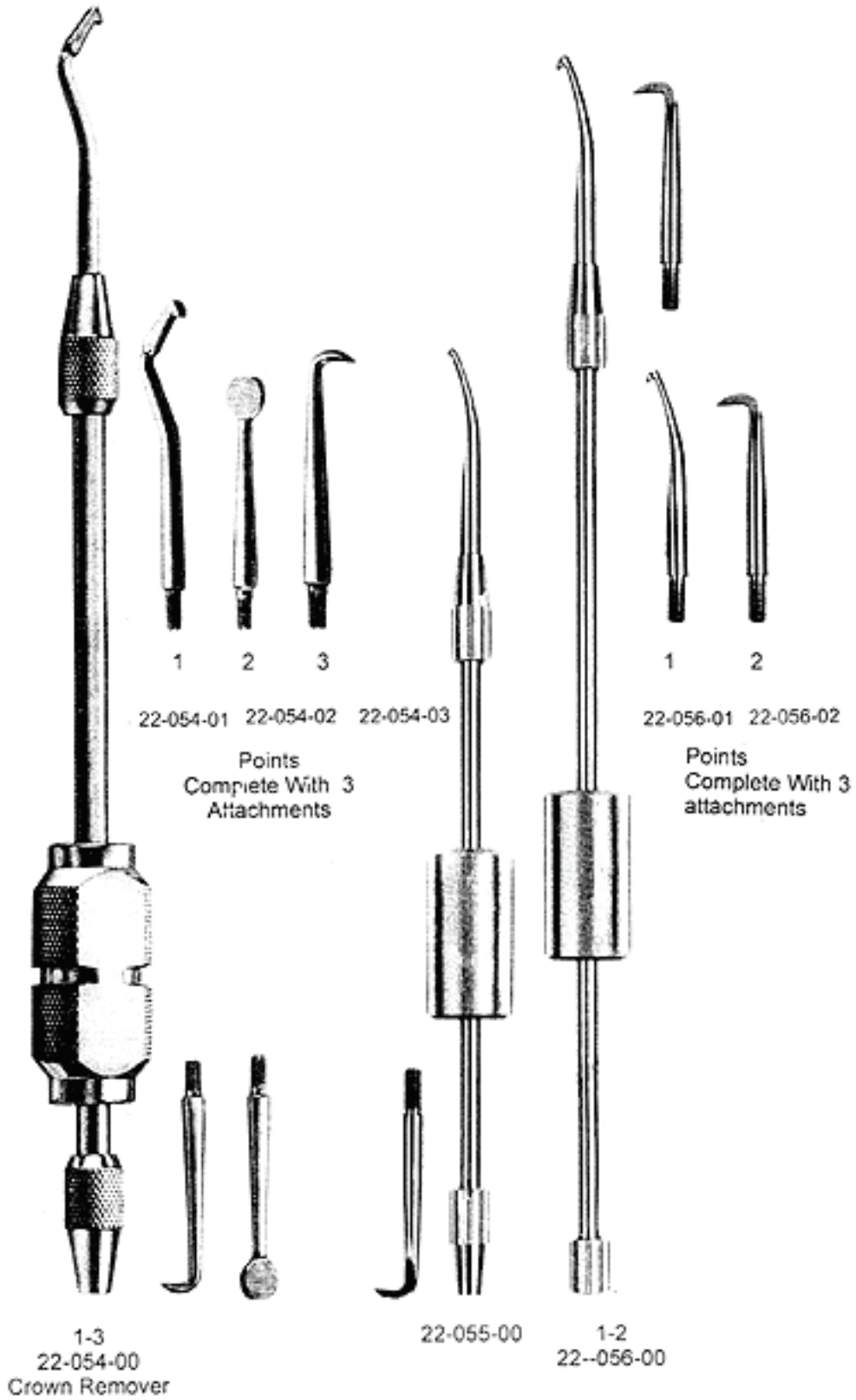

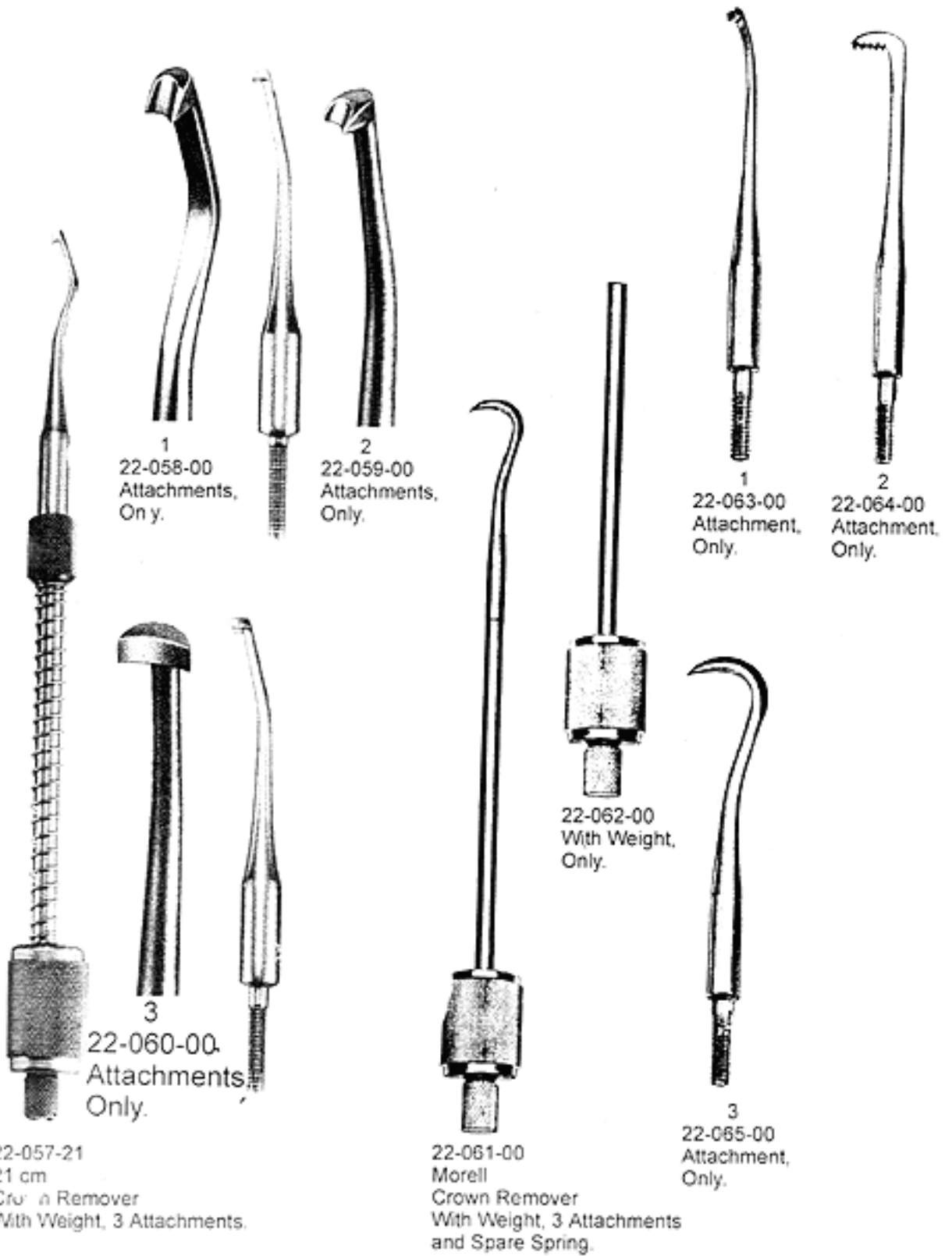

CROWN INSTRUMENTS
KRONEN INSTRUMENTE
INSTRUMENTOS PARA CORONAS



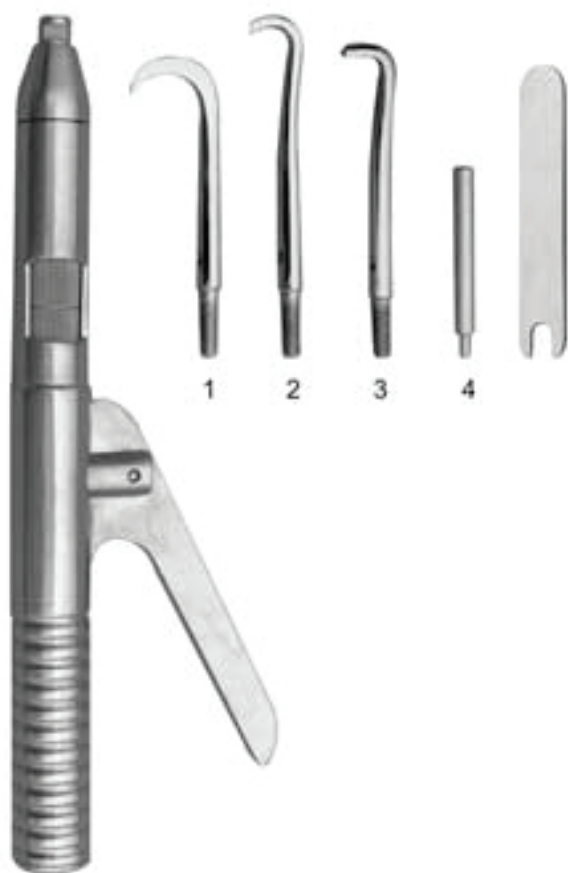

1-3
22-076-00



Crown
Removing Forcep
17 cm
22-078-17



22-097-00

Crown & Bridge Holding Forceps with support Ring
22-096-00



Ligature Instrument
22-098-00



Saliva Ejectors
22-099-00 Ø 3 mm
22-100-00 Ø 4 mm
22-101-00 Ø 5 mm
18 cm

Department

23

AMALGAM CARRIERS
AMALGAMPISTOLEN
PORTA AMALGAMAS

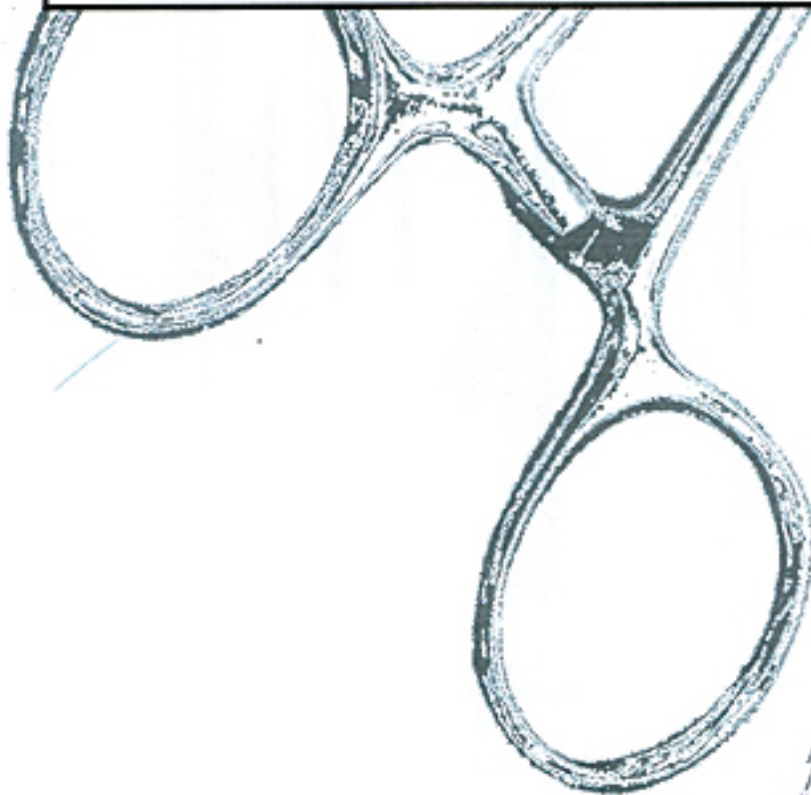
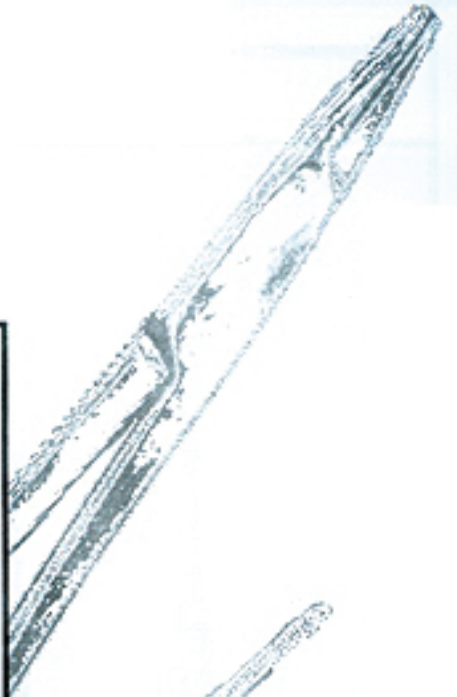

DEPARTMENT NO. 23

FROM
PAGE#

288

TO
PAGE#

295

INSTRUMENTS CATEGORY

AMALGAM CARRIERS
AMALGAMPISTOLEN
PORTA AMALGAMAS

AMALGAM CARRIERS
 AMALGAMPISTOLEN
 PORTA AMALGAMAS

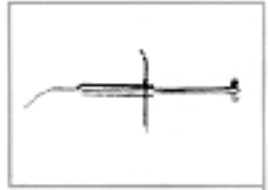

23-001-00
 Non-Slip
 Amalgam Well



23-002-00
 Amalgam Well

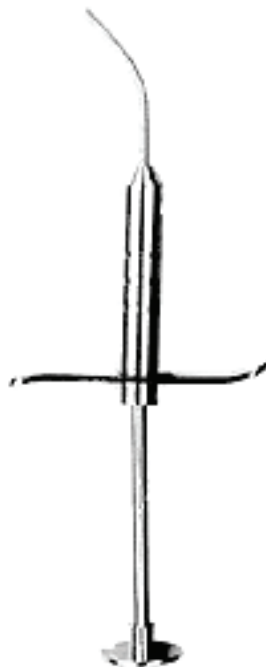

23-003-00
 Micro



1/1
 23-004-00

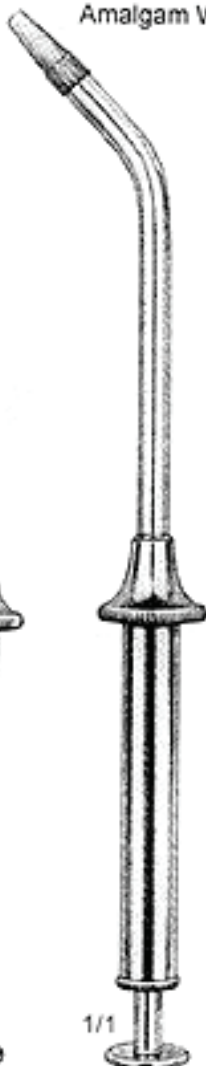

1/1
 23-005-00

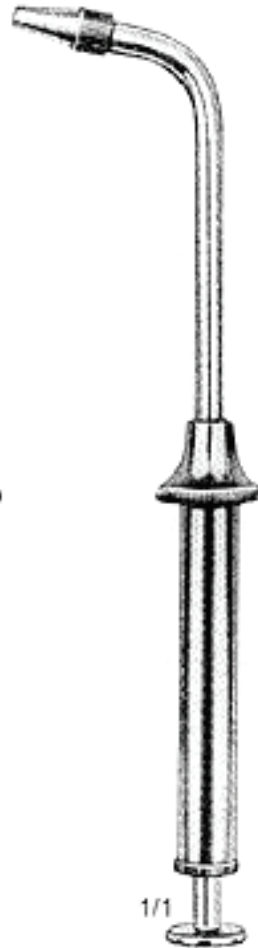

1/1
 23-006-00

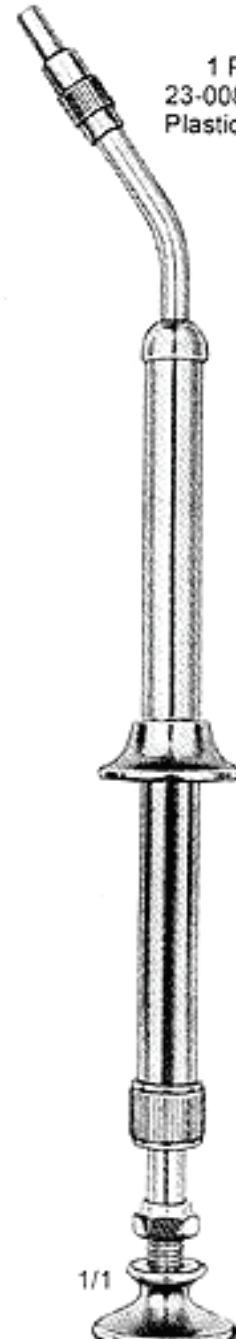

1/1
 23-007-00

1 P
 23-008-00
 Plastic Tip



2 P
 23-009-00
 Metal Tip



3
 23-010-00
 Metal Tip
 For 23-007-00



3
 23-011-00
 Plastic Tip
 For 23-007-00



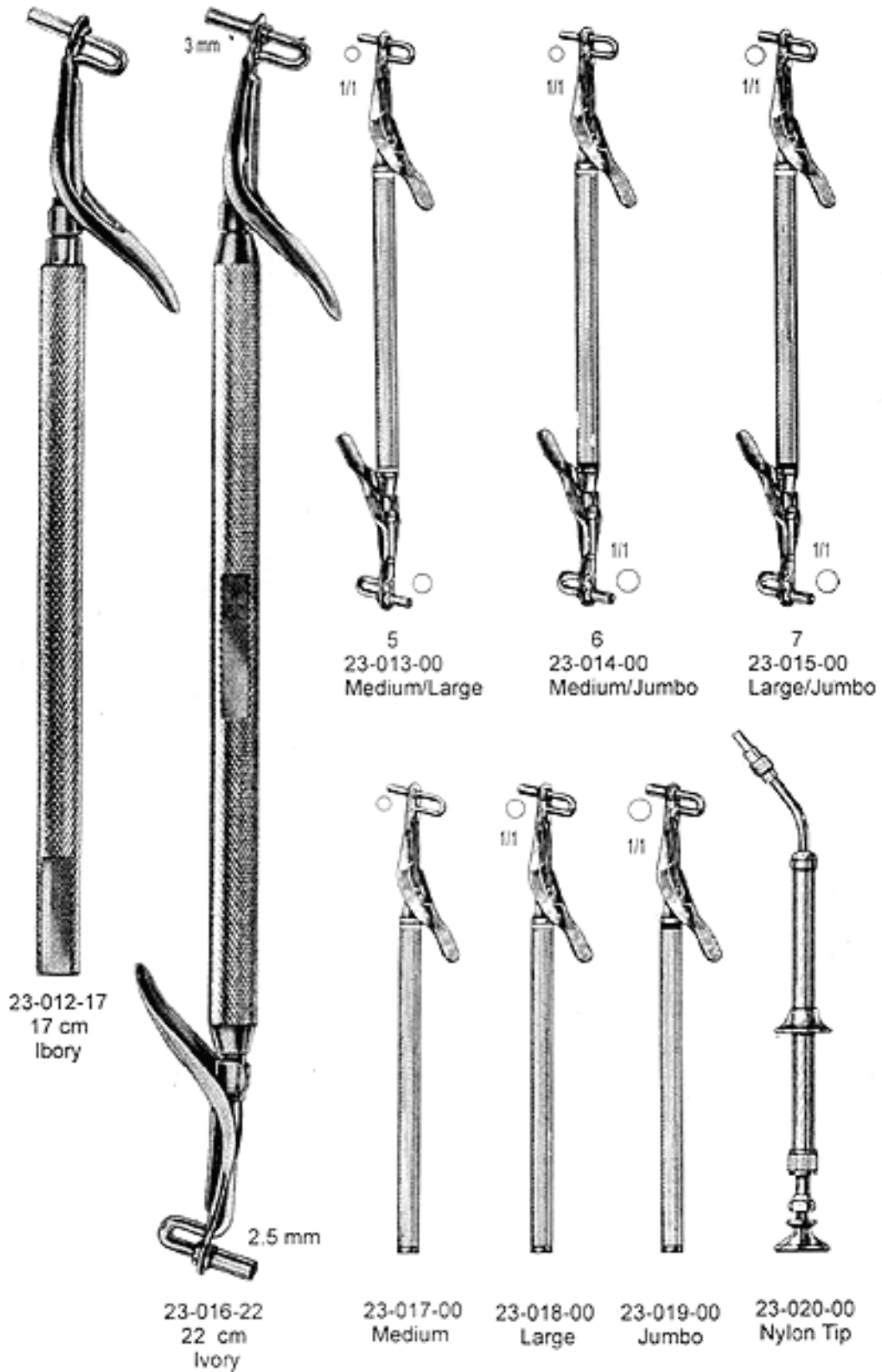

CARTRIDGE SYRINGES
 INJEKTIONSKANULEN
 JERINGAS PARA CARTUCHO



23-023-00

23-021-00 (1.8 ml)
 23-022-00 (2.2 ml)





23-026-00

23-024-00 (1.8 ml)
 23-025-00 (2.2 ml)

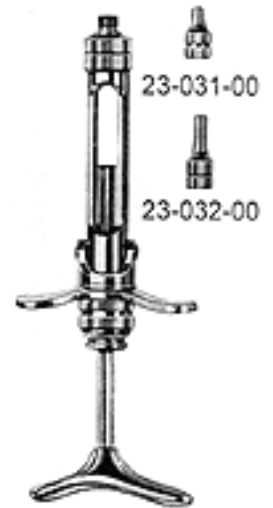

23-027-00 (1.8 ml)
 23-028-00 (2.2 ml)



23-031-00



23-032-00

23-029-00 (1.8 ml)
 23-030-00 (2.2 ml)



1/2

23-033-00 (1.8 ml)
 23-034-00 (2.2 ml)



23-035-00 (1.8 ml)
 23-036-00 (2.2 ml)



23-037-00 (1.8 ml)
 23-038-00 (2.2 ml)

Note:- Available Both In European & American.

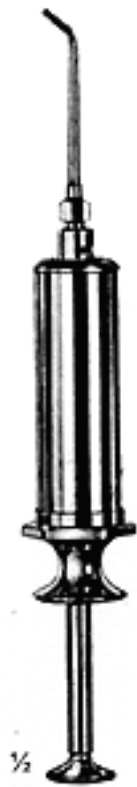

½

23-039-00



23-039-01

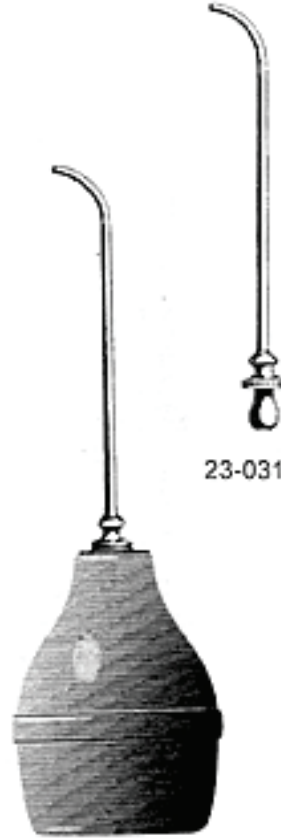

23-031-01

23-040-00



½

23-041-05
Without Valve



23-042-00
With Valve

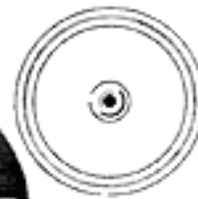

11

CARTRIDGE SYRINGES
INJEKTIONSKANULEN
JERINGAS PARA CARTUCHO



23-043-00 (1.8 ml)
23-044-01 (2.2 ml)



23-045-00 (1.8 ml)
23-046-01 (2.2 ml)



23-049-00 (1.8 ml)
23-048-01 (2.2 ml)



23-051-00 (1.8 ml)
23-052-01 (2.2 ml)



23-053-00 (1.8 ml)
23-054-01 (2.2 ml)
Cork Screw Tip



23-055-00 (1.8 ml)
23-056-01 (2.2 ml)



23-057-00 (1.8 ml)
23-058-01 (2.2 ml)

Note:- Available Both In European & American.



23-059-00
INTRALIGAMENTAL SYRINGE (PISTOL Shaped)



INTRALIGAMENTAL SYRINGES



23-060-00

Injects 0.06 ml with every click



23-061-00

Injects 0.05 ml with every click.
Easy attach / detach luer lock system.
Angled tip allows easy access to inject in difficult areas.
Special featured release button.



23-062-00

Injects 0.05 ml with every click.
Easy attach / detach luer lock system.
Angled tip allows easy access to inject in difficult areas.

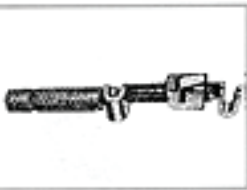

23-110-00



23-111-00
 Junior



23-112-00
 Senior

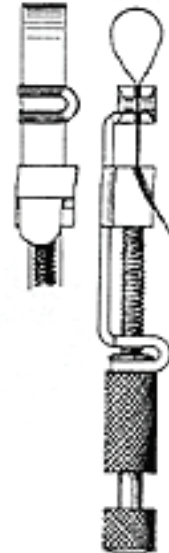

23-113-00
 Universal
 Tofflemire



23-114-00
 Ivor 1



23-115-00
 Ivor 12



1
 23-116-00



2
 23-117-00

— Nystrom —

Department

24

HANDLES FOR MOUTH MIRRORS
MUNDSPIEGELGRIFFE
MANGOS PARA ESPEJOS DE BOCA

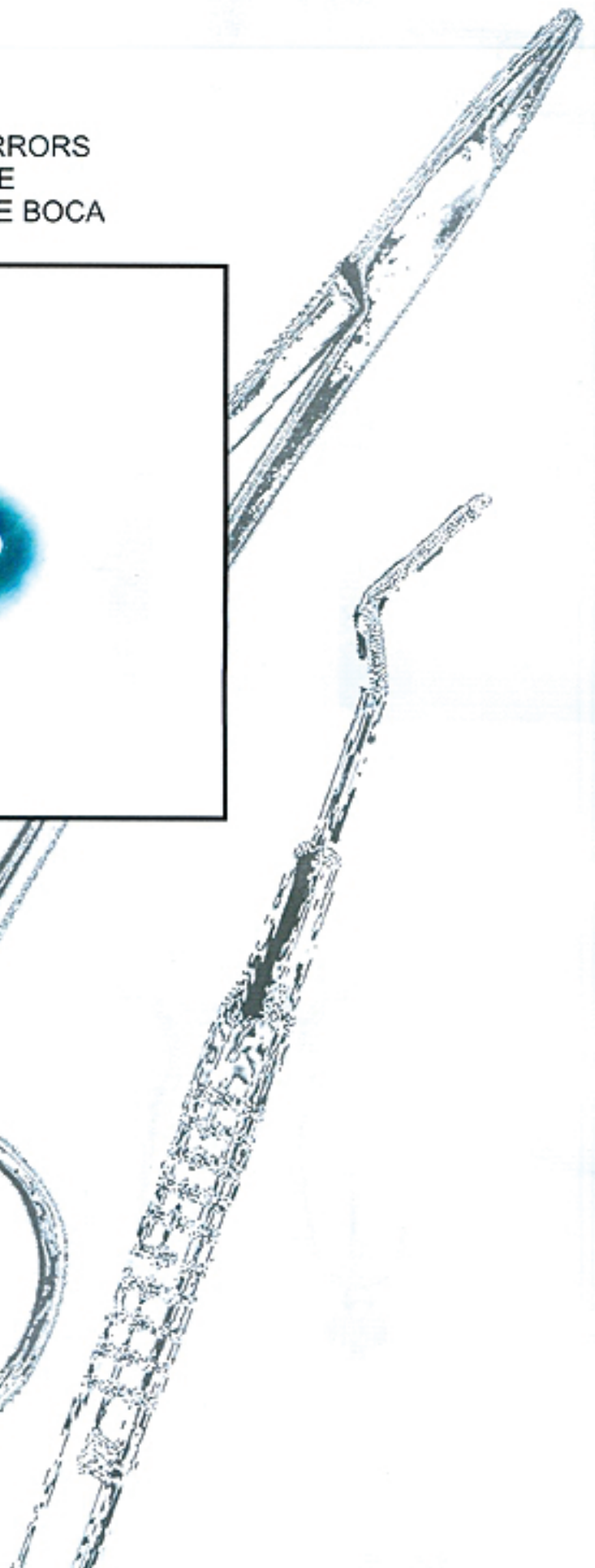
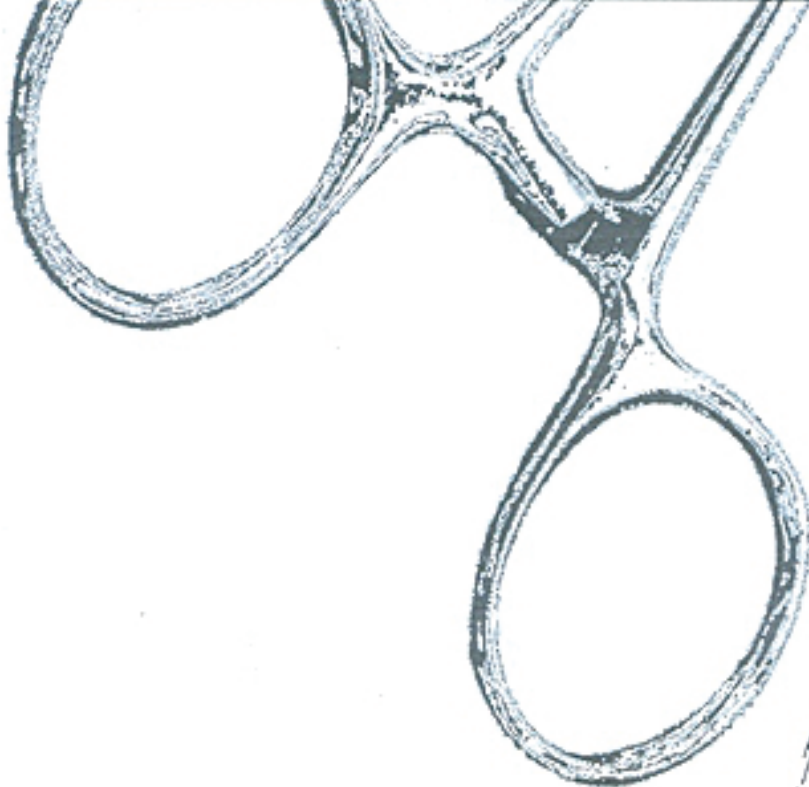
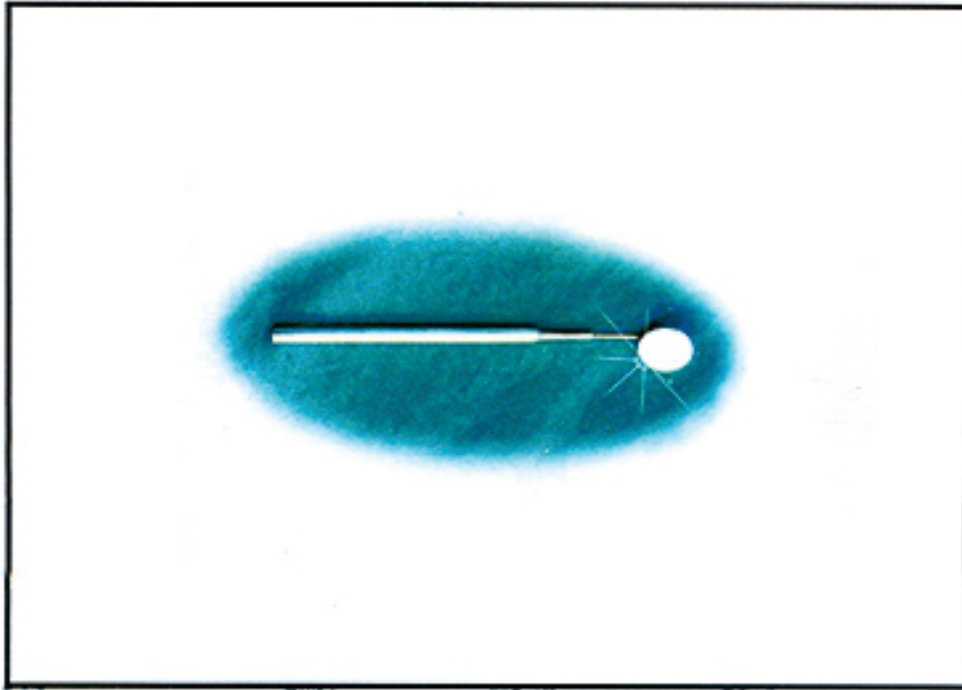

DEPARTMENT NO. 24

FROM
PAGE#

TO
PAGE#

296

300

INSTRUMENTS CATEGORY

HANDLES FOR MOUTH MIRRORS
MUNDSPIEGELGRIFFE
MANGOS PARA ESPEJOS DE BOCA

HANDLES FOR MOUTH MIRRORS
MUNDSPIEGELGRIFFE
MANGOS PARA ESPEJOS DE BOCA

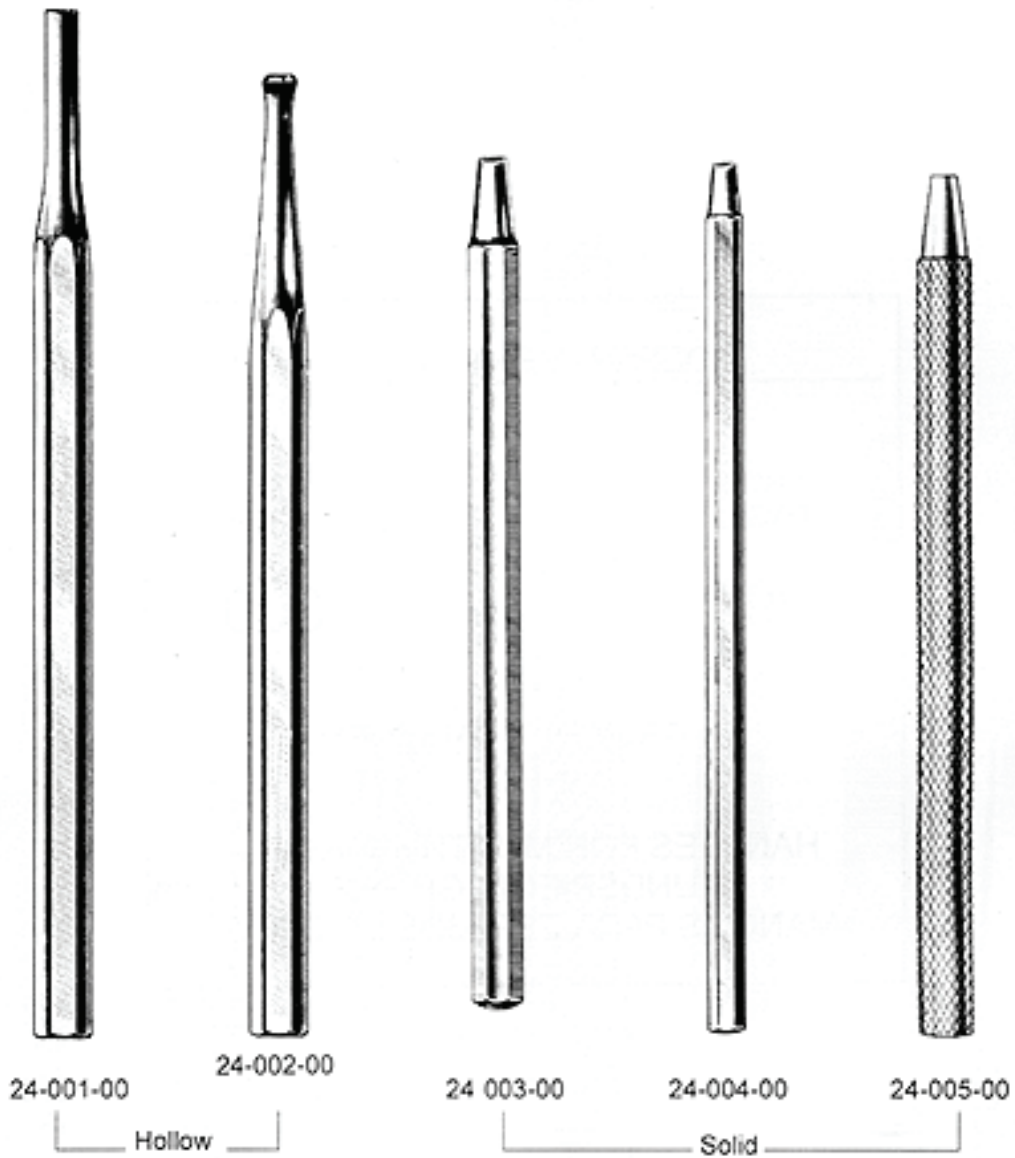

Note:- Available Both In European & American Thread

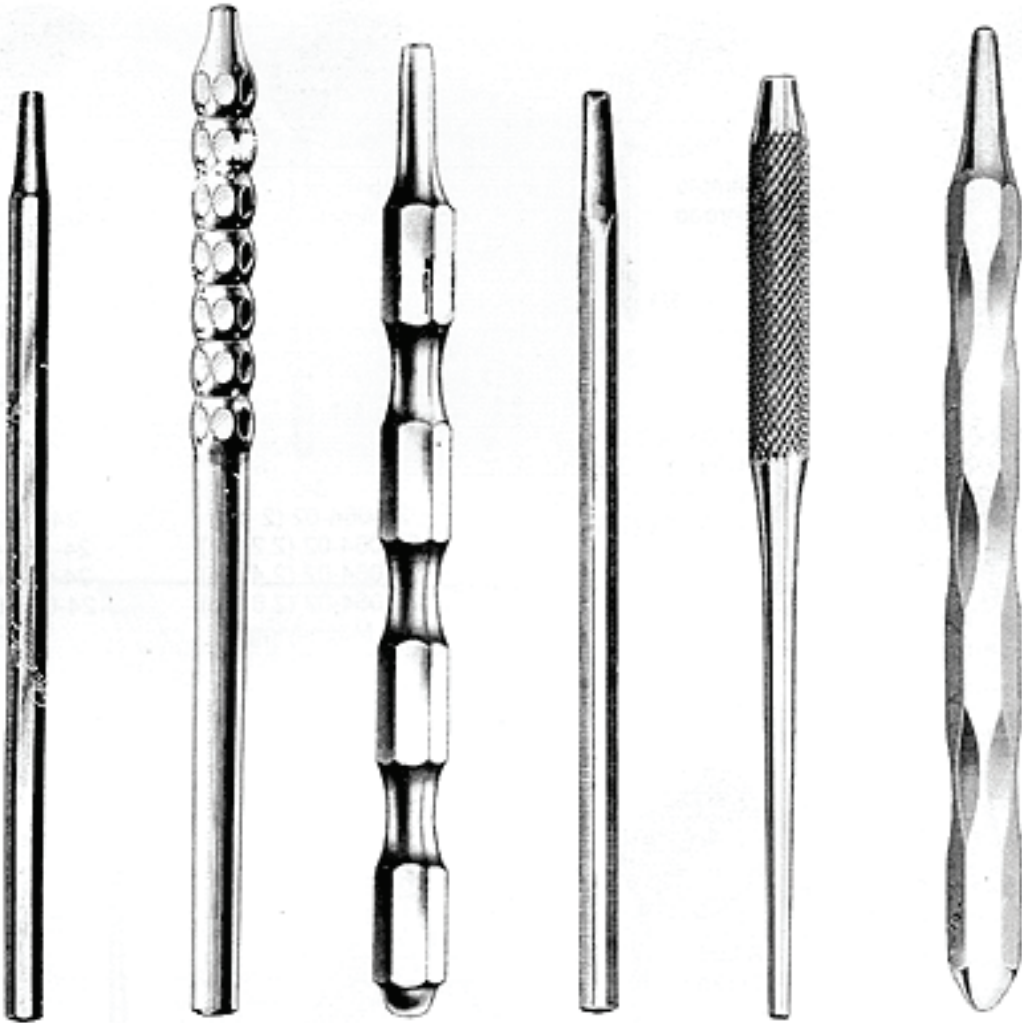

24-006-00
Solid

24-007-00
Hollow

24-008-00
Solid

483
24-009-00

487 Rs
24-010-00
Solid

489 Rs
24-011-00
Hollow

Note:- Available Both In European & American Thread

MOUTH MIRRORS
MUNDSPIEGEL
ESPEJOS DE BOCA

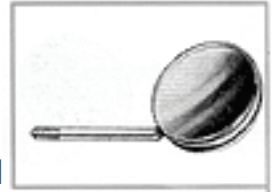

24-062-02 (2 cm)
24-062-02 (2.2 cm)
24-062-02 (2.4 cm)
24-062-02 (2.6 cm)
Magnifying



24-063-02 (2 cm)
24-063-02 (2.2 cm)
24-063-02 (2.4 cm)
24-063-02 (2.6 cm)
Plain



24-064-02 (2 cm)
24-064-02 (2.2 cm)
24-064-02 (2.4 cm)
24-064-02 (2.6 cm)
Magnifying



24-065-02 (2 cm)
24-065-02 (2.2 cm)
24-065-02 (2.4 cm)
24-065-02 (2.6 cm)
Plain



24-066-02 (2 cm)
24-066-02 (2.2 cm)
24-066-02 (2.4 cm)
24-066-02 (2.6 cm)
Plain (Front Surface)
Rhodium Plated



Note:- Available both in European & American Thread.
All Mouth Mirrors are also Available Twelve Pieces in one Packing.

Department

25

SCALPLE HANDLES
SKALPELL-GRIFFE
MANGOS DE BISTURIAS

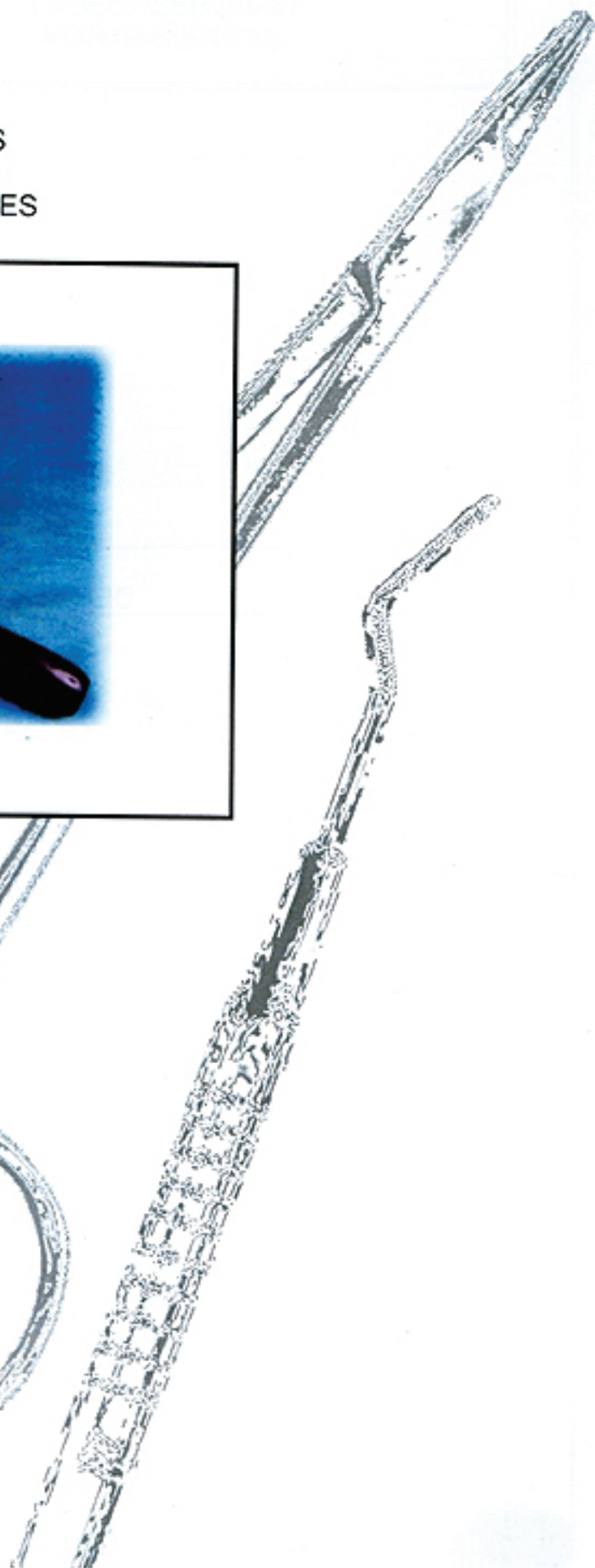
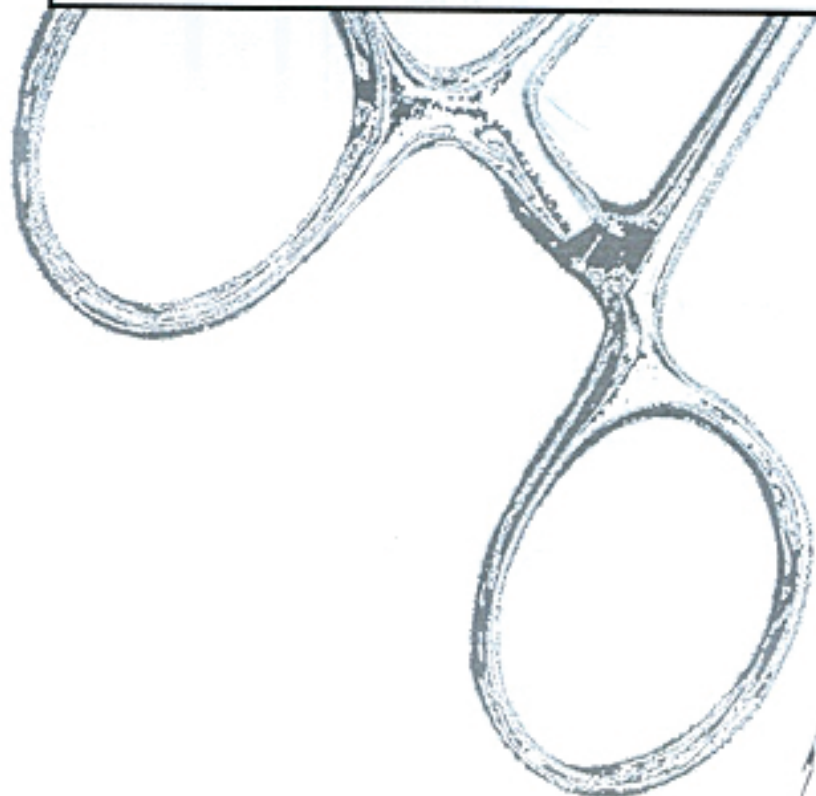

DEPARTMENT NO. 25

FROM
PAGE#

301

TO
PAGE#

304

INSTRUMENTS CATEGORY

SCALPLE HANDLES
SKALPELL-GRIFFE
MANGOS DE BISTURIES

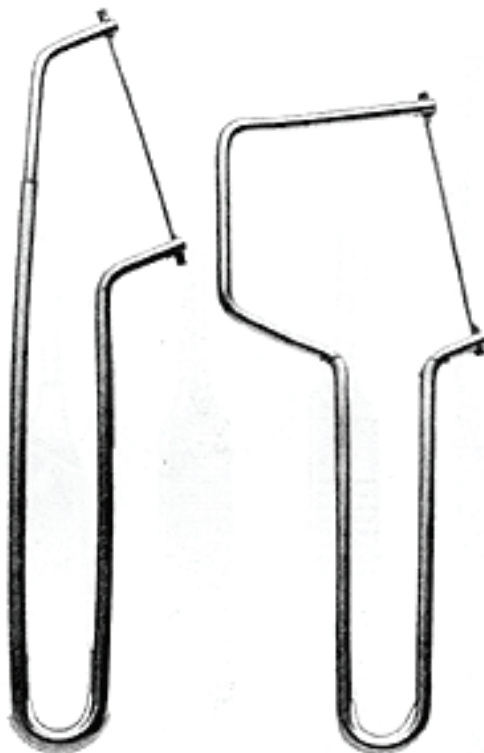
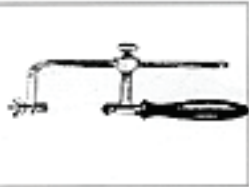

25-001-20
20 cm
Model Saw

25-002-18
18 cm
Bowed
Model Saw

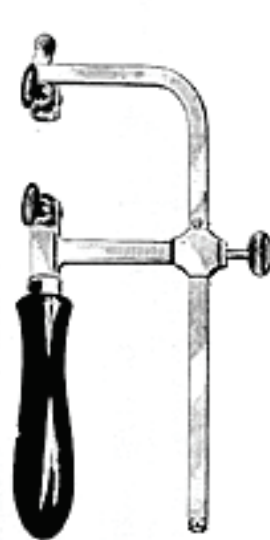

25-003-00
Fret Saw Frames,
Adjustable

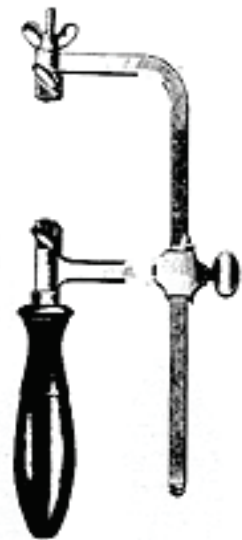

25-004-00
Fret Saw Frames,
Adjustable

SCALPLE HANDLES
SKALPELL-GRIFFE
MANGOS DE BISTURIES

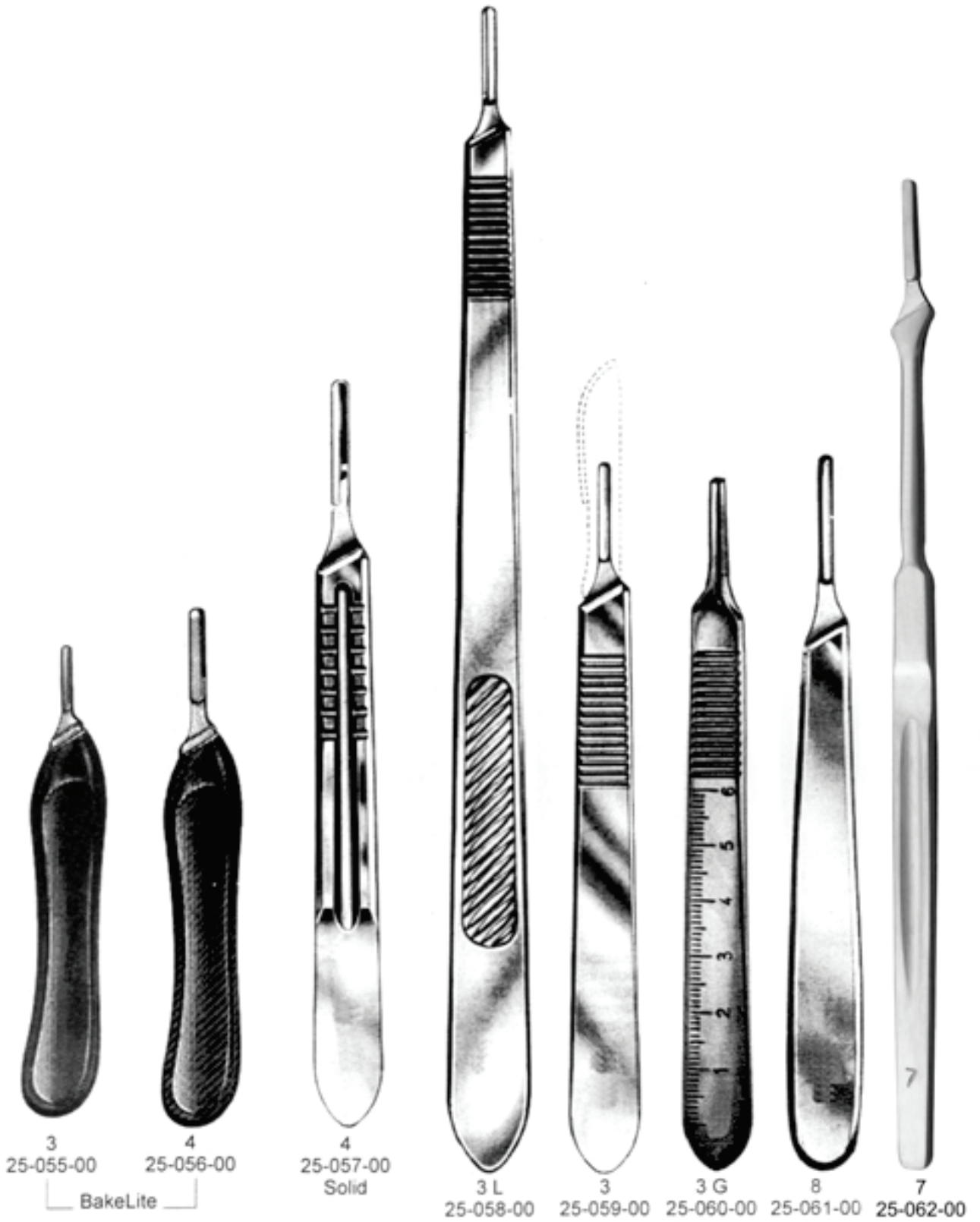

Department

26

HAMMER
MALLETS
MARTILLOS Y MAZOS

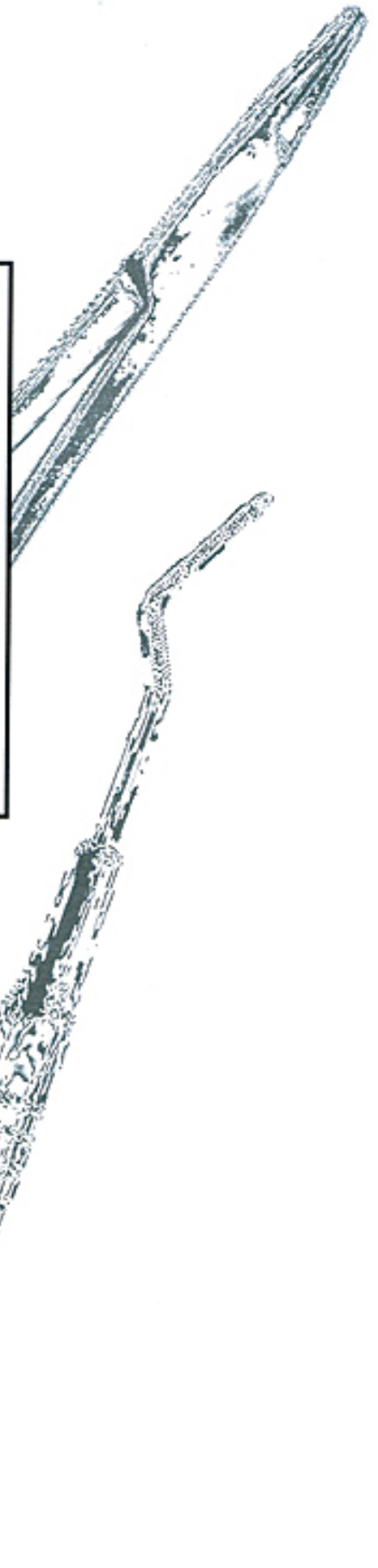
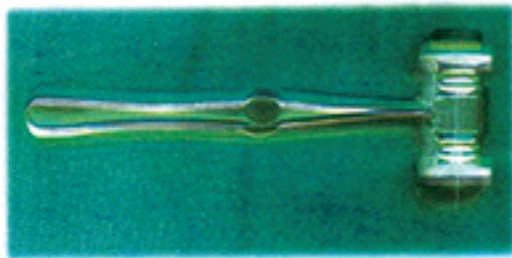

DEPARTMENT NO. 26

FROM
PAGE#

305

TO
PAGE#

308

INSTRUMENTS CATEGORY

HAMMER
MALLETS
MARTILLOS Y MAZOS

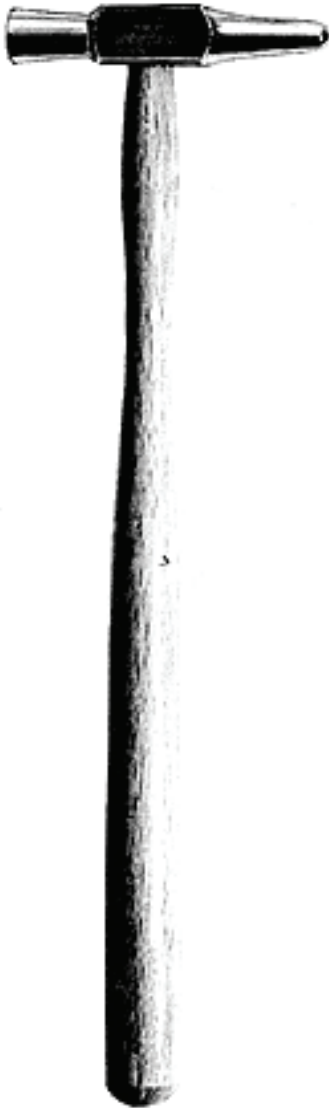

26-001-22
22 cm
Riveting Mallets



26-002-22
22 cm

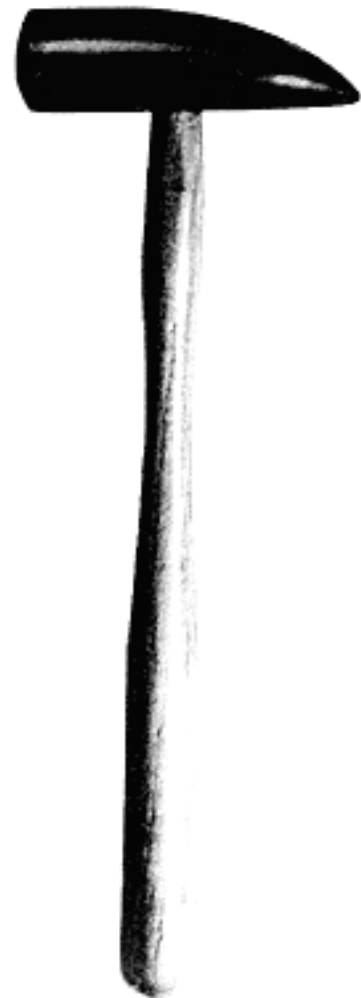

26-003-20
20 cm
Horn Mallet

HAMMER
MALLET
MARTILLOS Y MAZOS

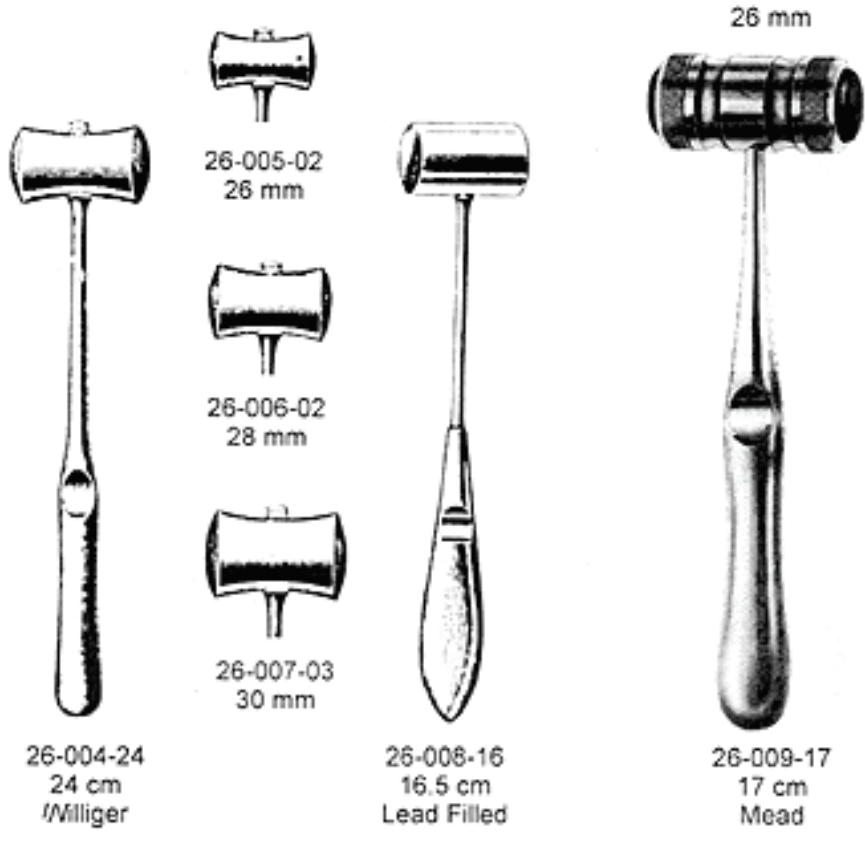

Department

27

CARVING INSTRUMENTS
MODELLIER INSTRUMENTE
INSTRUMENTOS PARA MODELAR

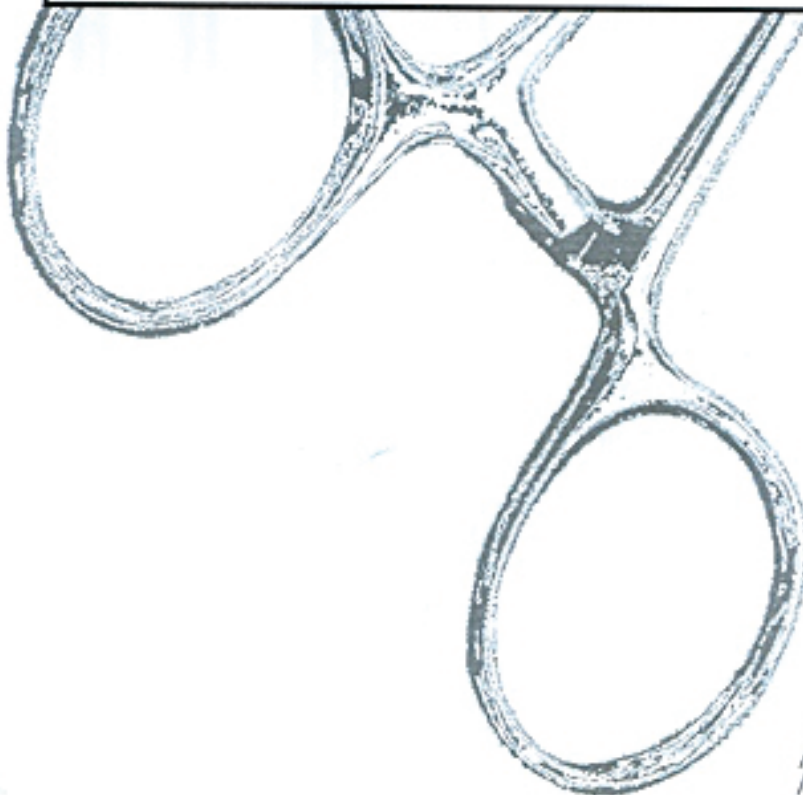
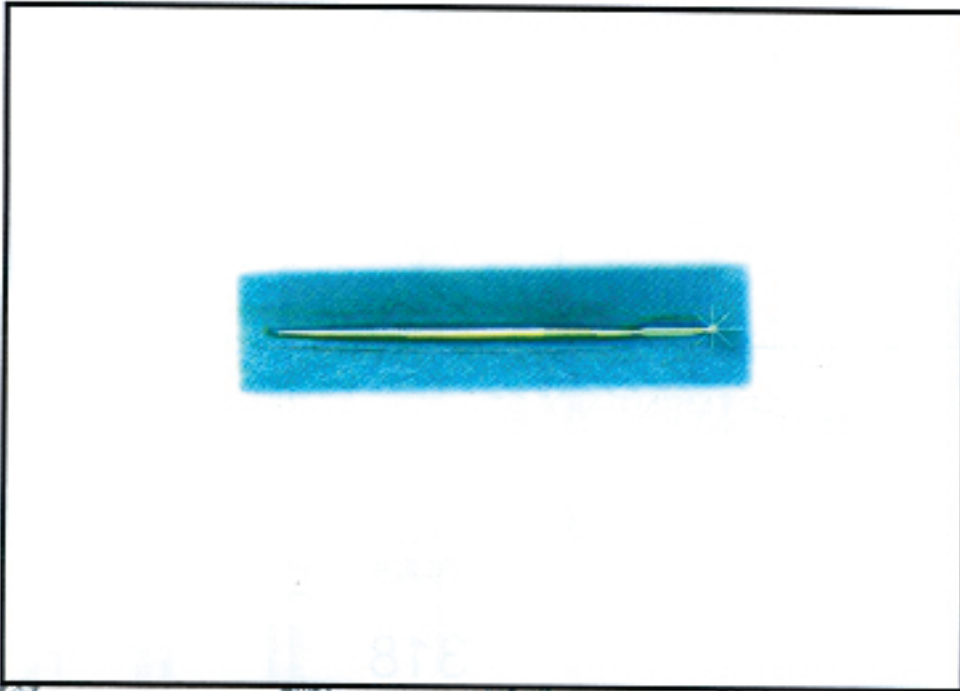

DEPARTMENT NO. 27

FROM
PAGE#

309

TO
PAGE#

318

INSTRUMENTS CATEGORY

CARVING INSTRUMENTS
MODELLIER INSTRUMENTE
INSTRUMENTOS PARA MODELAR

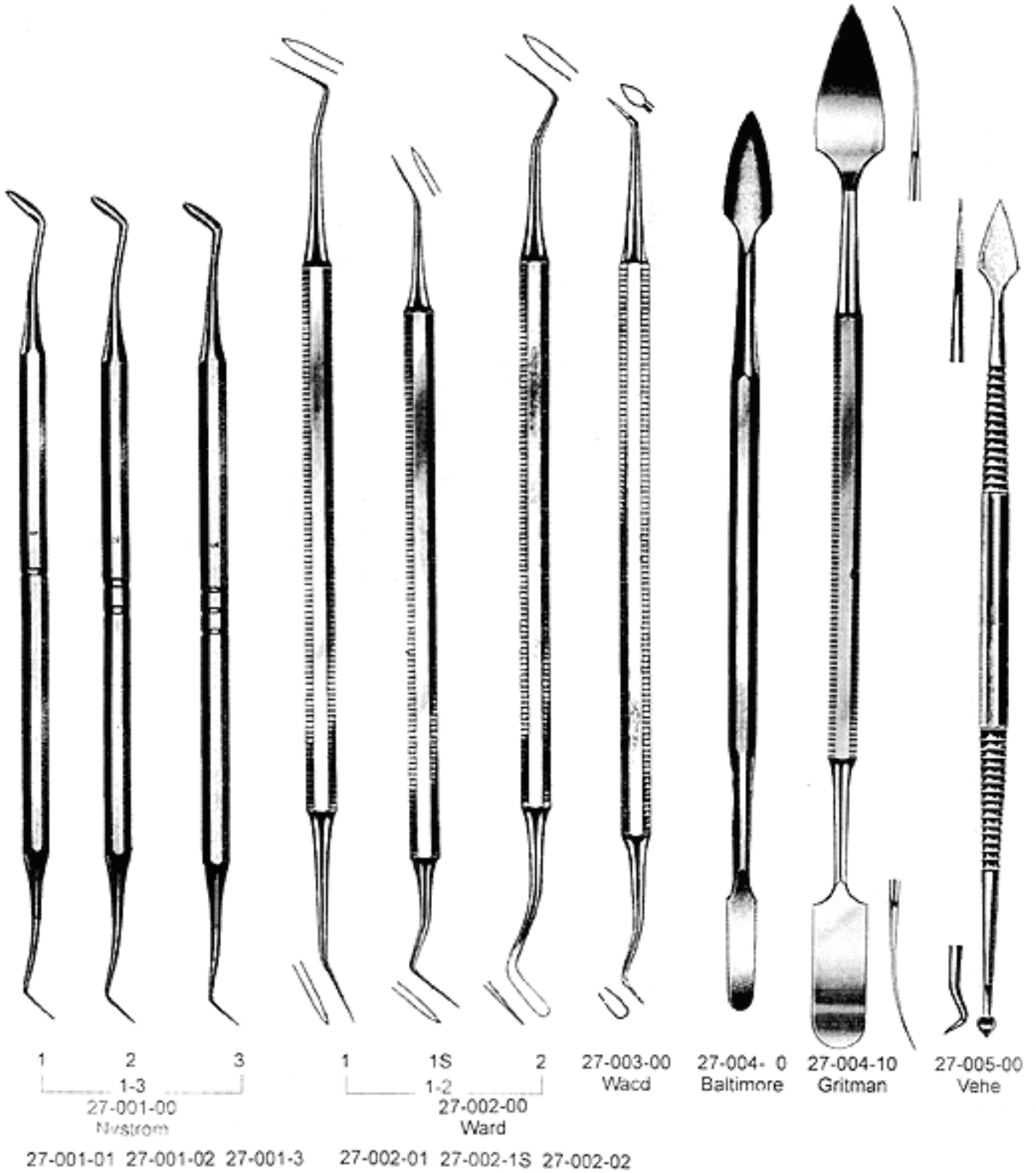

CARVING INSTRUMENTS
 MODELLIER INSTRUMENTE
 INSTRUMENTOS PARA MODELAR

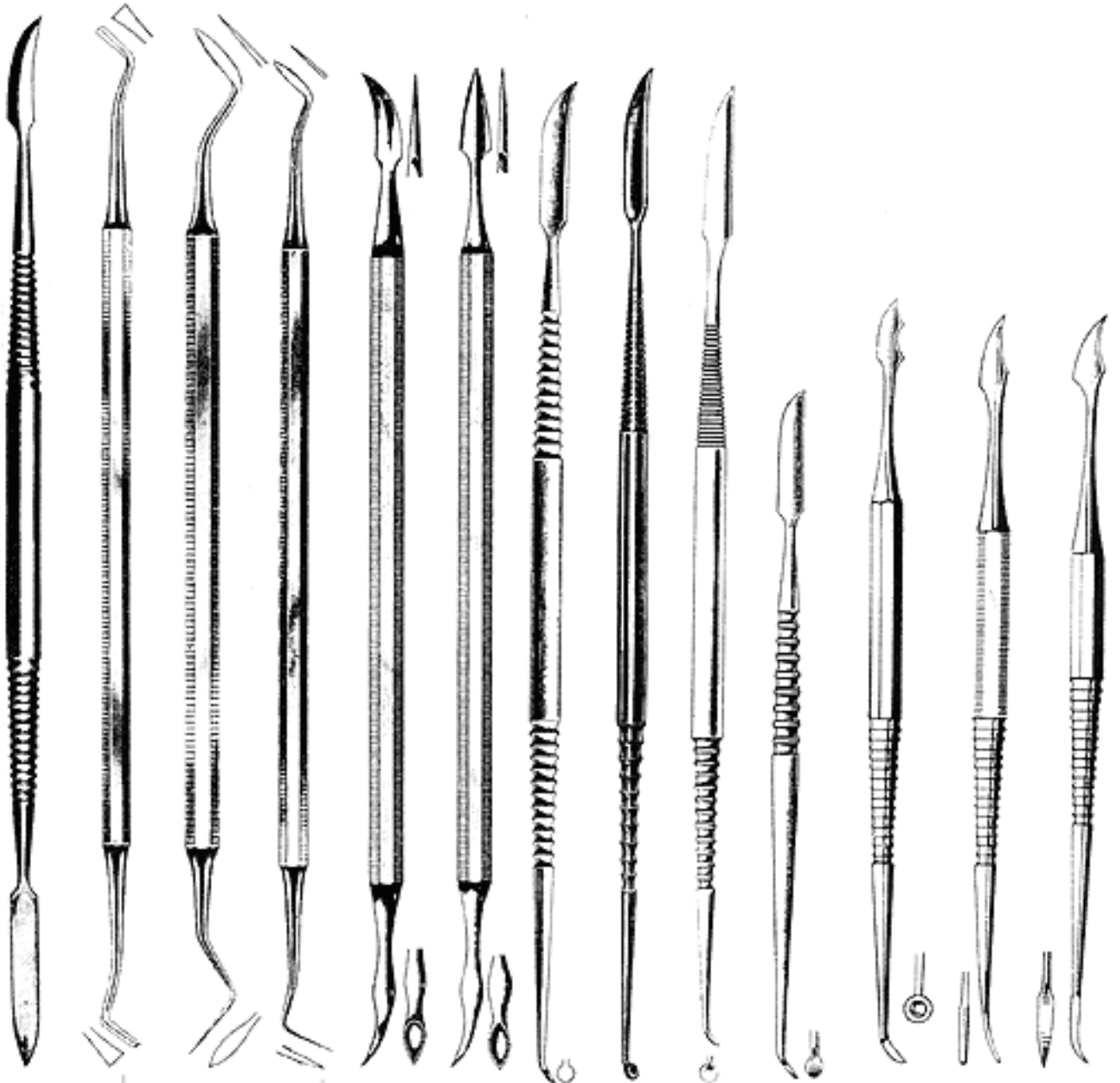

27-006-00
 Reeve
 27-007-00
 Hollenback

27-008-00
 Hollenback
 27-009-00
 Hollenback

27-010-00
 Roach
 27-011-00
 Roach

27-012-00
 Le Cron
 27-013-00
 Le Cron

27-014-00
 Le Cron
 27-015-00
 Le Cron

27-016-00
 Zahle
 27-017-00
 Zahle

27-018-00
 Zahle



27-019-00
Hylin



27-020-00
Hylin-Le Cron



27-021-00
Hylin-Ceramica



27-022-00
Hylin



27-023-00



27-024-00
Le Cron



27-025-00
Le Cron

MODELLING CARVERS
MODELLIER INSTRUMENTE
TALLADORES PARA MODELAR

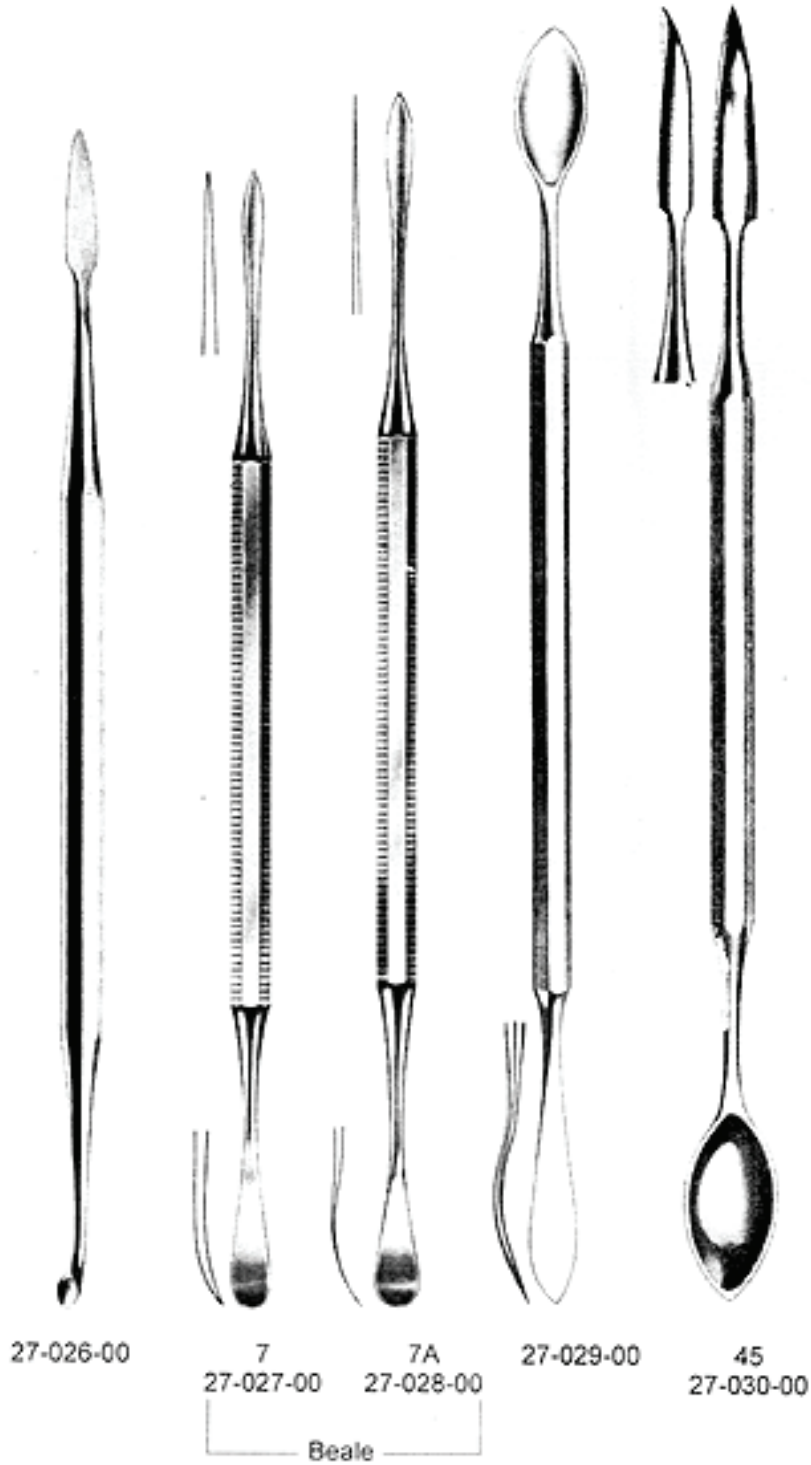

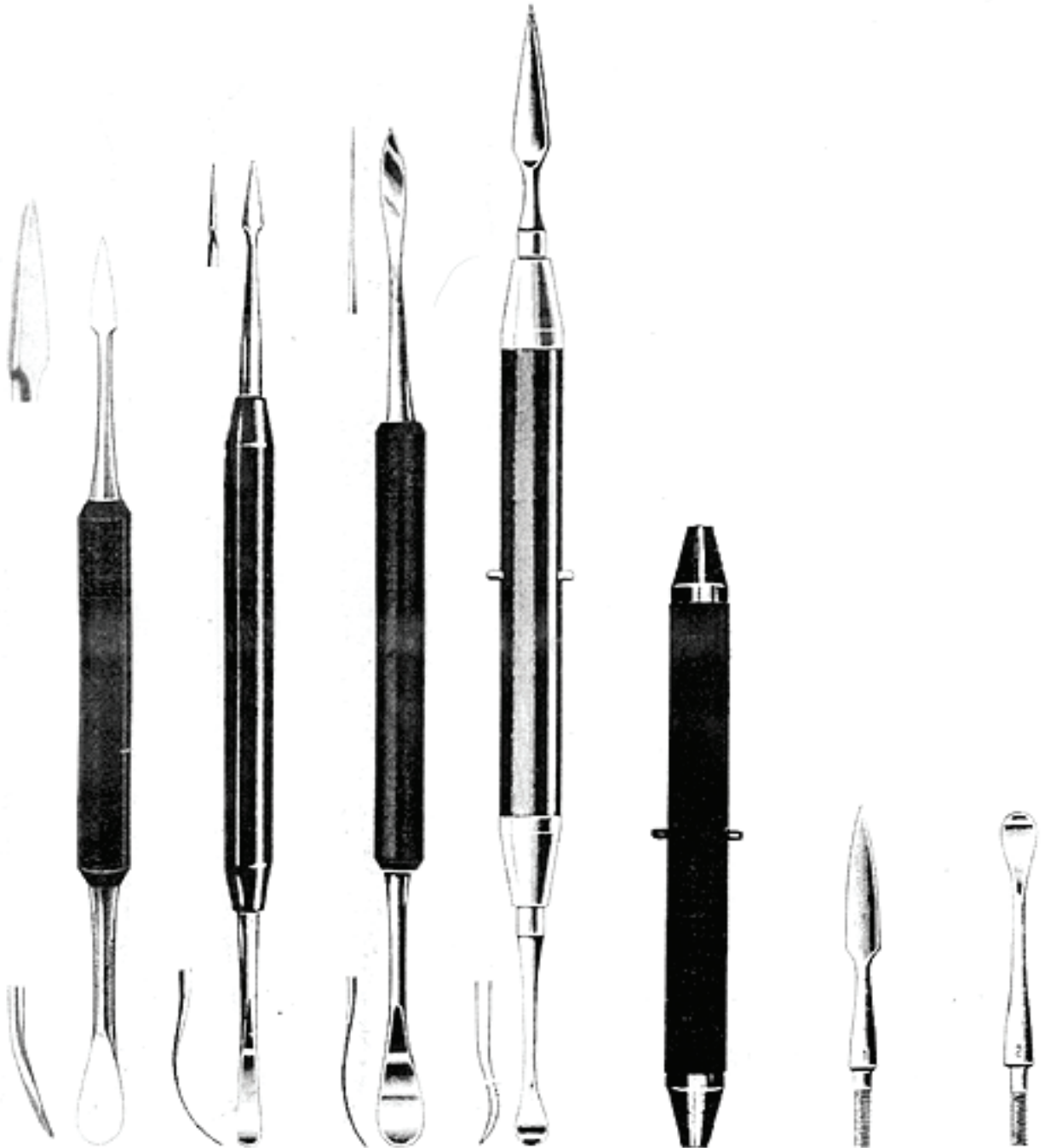

27-031-00
Taylor

27-032-00
Falck

27-033-00
Beale

27-034-00
Acker

27-035-00
Handle, Only

27-036-00
Attachment Only

27-037-00
Attachment Only

CARVING INSTRUMENTS
MODELLIER INSTRUMENTE
INSTRUMENTOS PARA MODELAR

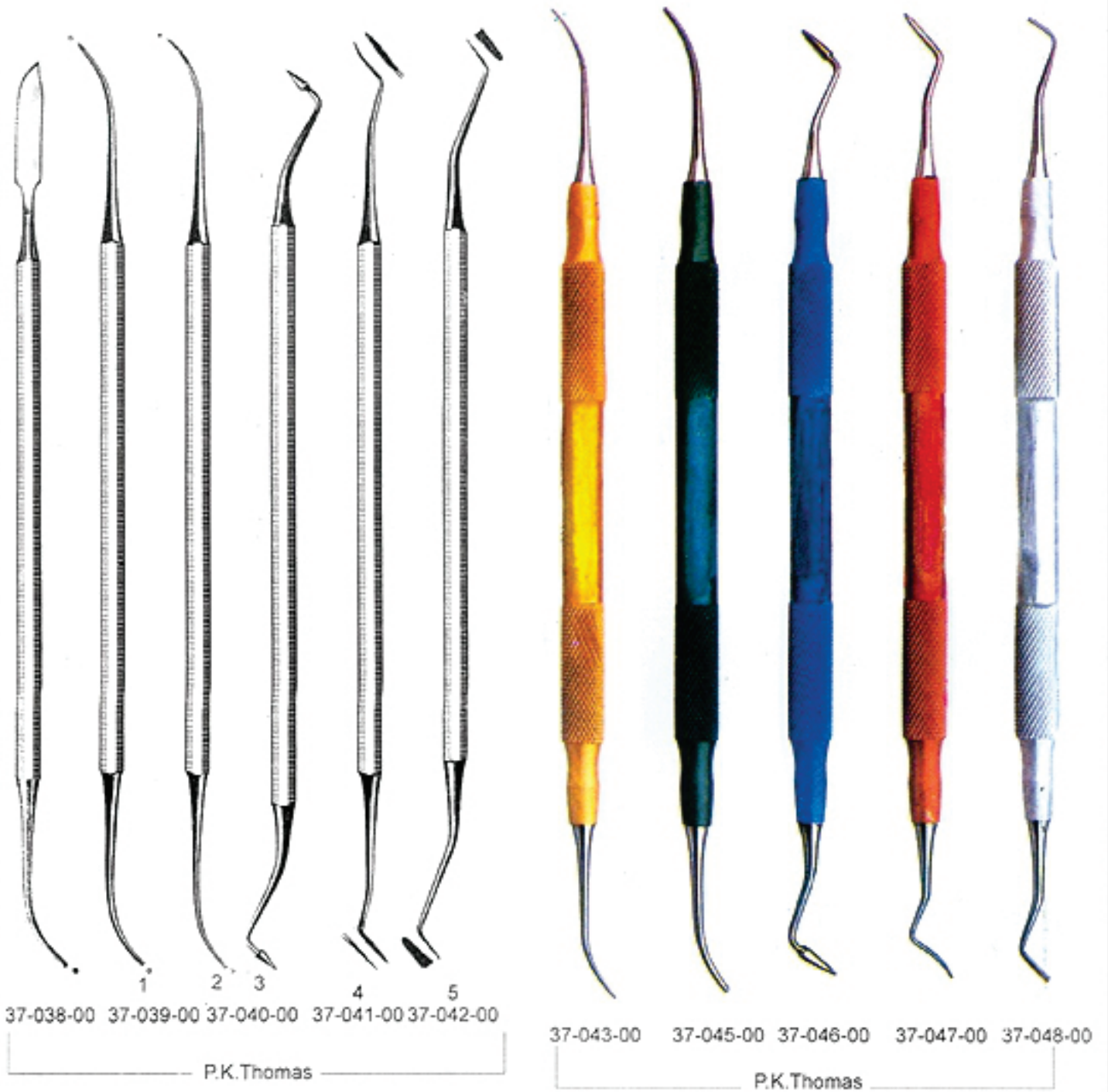

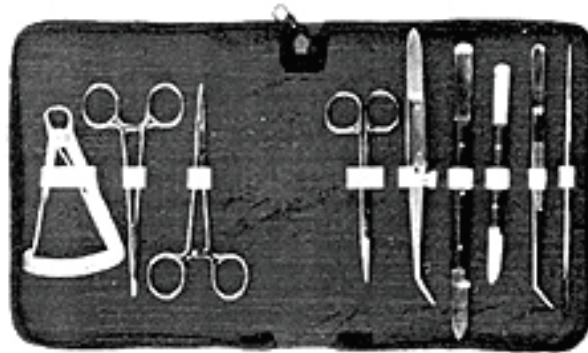

27-049-00
 Modeling Instrument
 Set in Pouch.

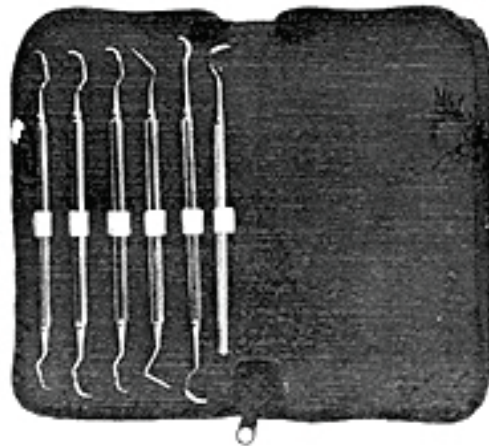

37-050-00
 Modeling Instrument
 Set in Pouch.

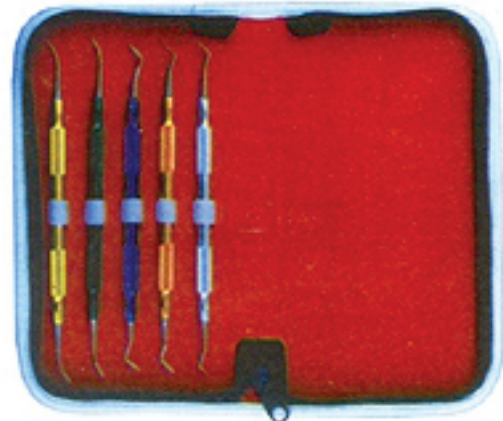

37-051-00
 Modeling Instrument
 Set in Pouch.

CARVING INSTRUMENTS
MODELLIER INSTRUMENTE
INSTRUMENTOS PARA MODELAR

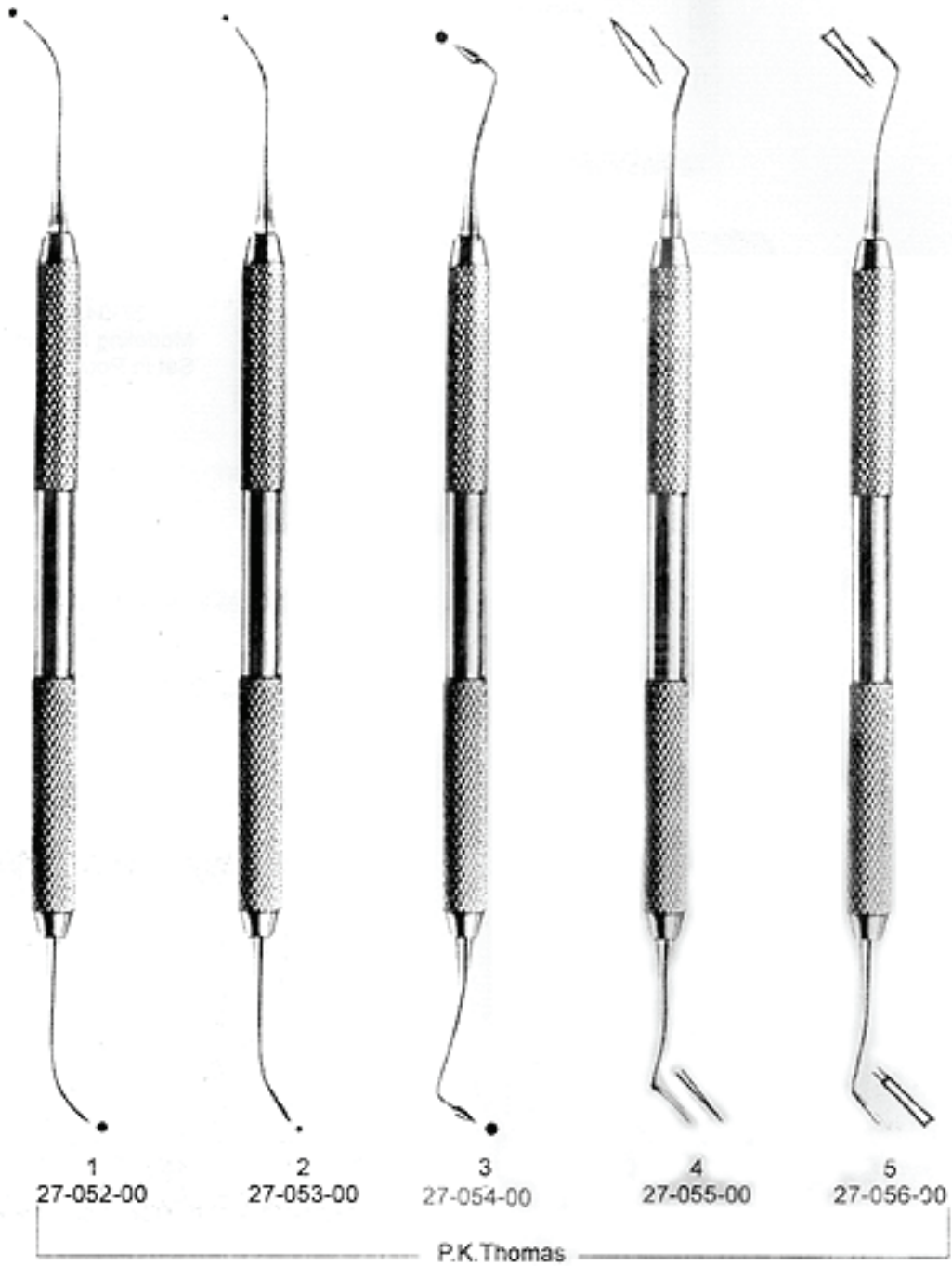



27-058-01



27-059-02

27-057-00



27-061-01



27-062-02

27-060-00



27-064-01



27-065-02

27-063-00

PROGRAM SOUL STUNTING INSTRUMENTS
KEMENTERIAN KESEHATAN RI
KEMENTERIAN PERKOTAAN, TRANSPORTASI DAN INFRASTRUKTUR



www.medisana.com

1. PENDAHULUAN

2. TUJUAN

3. METODE PENELITIAN

4. HASIL PENELITIAN

5. PEMBAHASAN

6. PENUTUP

DAFTAR PUSTAKA

Lampiran

Department

28

WAX KNIVES
WACHSMESSER
CUCHILLOS PARA CERA

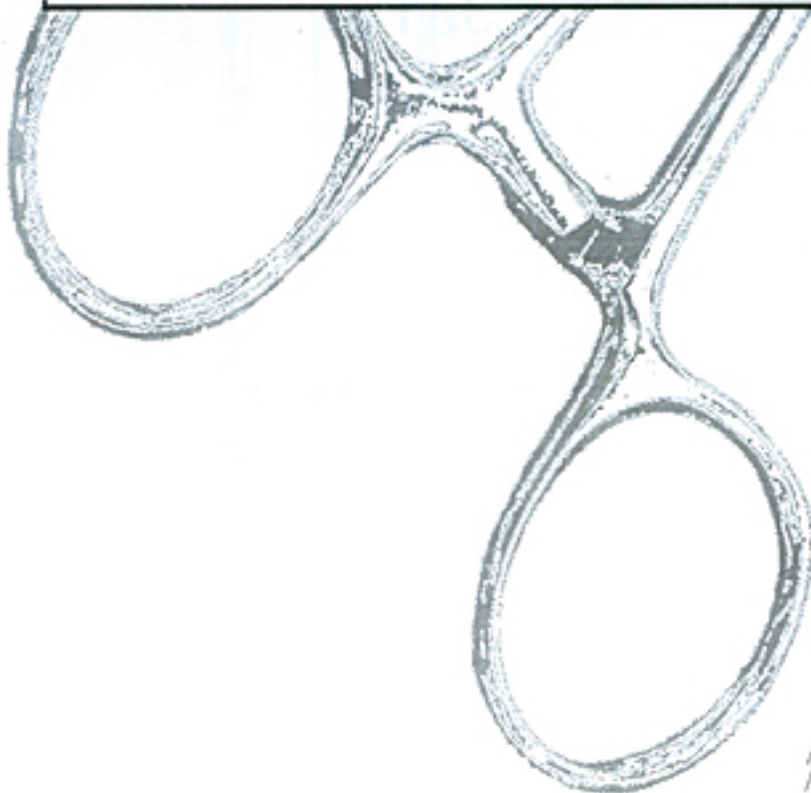
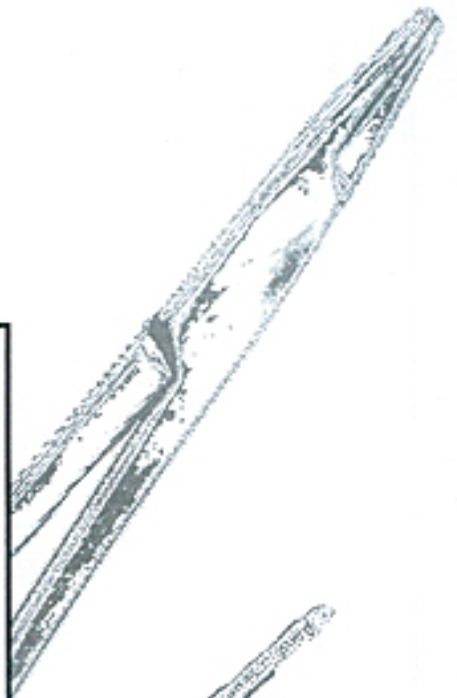

DEPARTMENT NO. 28

FROM
PAGE#

319

TO
PAGE#

331

INSTRUMENTS CATEGORY

WAX KNIVES
WACHSMESSER
CUCHILLOS PARA CERA

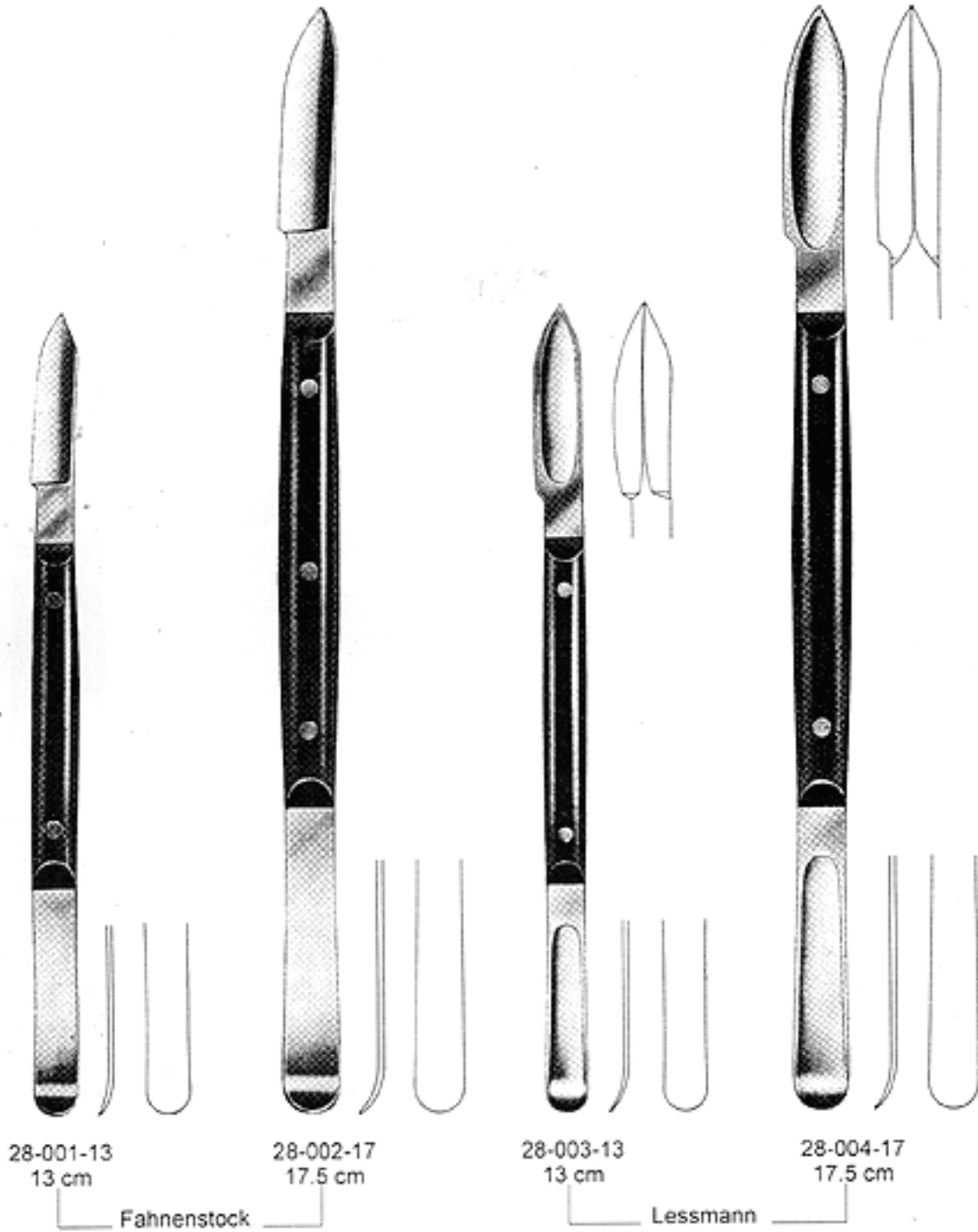

WAX KNIVES
WACHSMESSER
CUCHILLOS PARA CERA



WAX KNIVES
WACHSMESSER
CUCHILLOS PARA CERA

28



28-012-00



28-013-00
Sach



28-014-00



28-015-00
Gritman



1/2

28-016-00

ALGINATE AND PLASTER SPATULAS
ALGINATE UND GIPSPATEL
ESPATULAS PARA ALGINATO Y PARA YESO



28-063-00

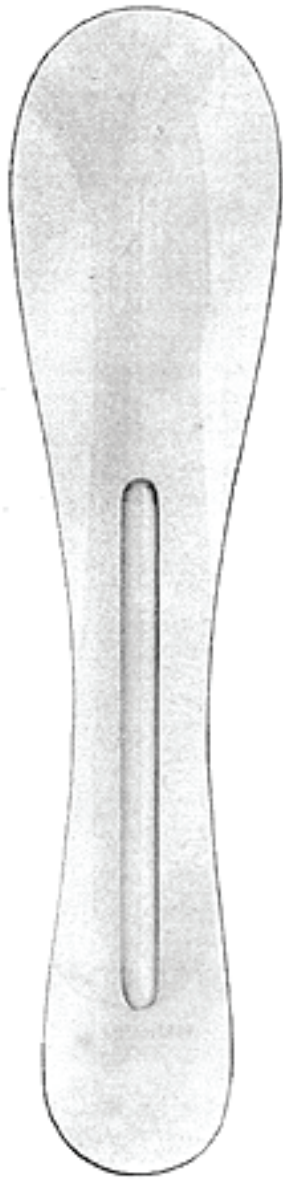

28-064-00
Lichtenstein



28-065-00
Flexibel



28-066-00



28-067-00
Flexibel



28-068-18
18.5 cm



28-069-19
19.5 cm



28-070-21
21.5 cm



28-071-20
20.5 cm

PLASTER CUTTING FORCEPS
GIPSSCHNEIDE UND GIPSBRUCHZANGE
ALICATE PARA YESO

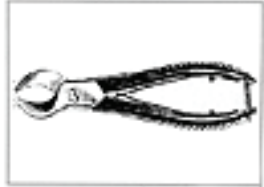

28-122-00



28-123-00



28-124-00



28-165-15
15 cm



28-166-15
15 cm
Miller

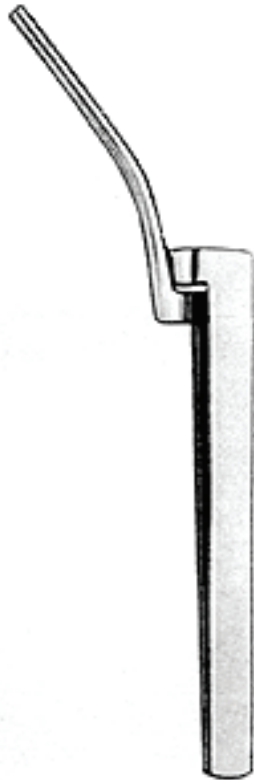

28-167-15
15 cm

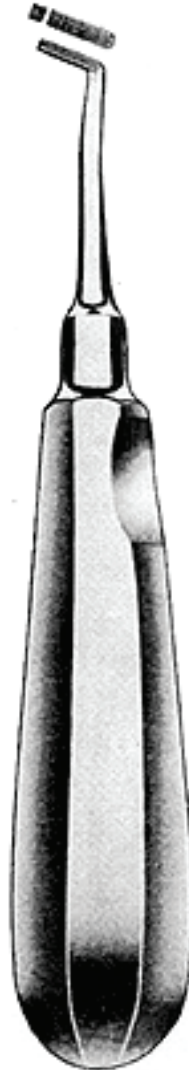

28-168-00
Mershon



1/1

28-169-00

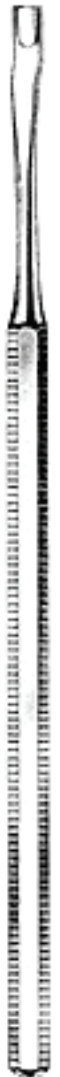

1/1

28-170-00
Steiner

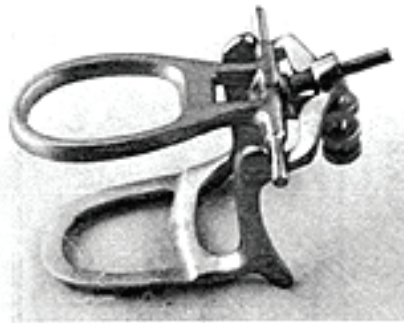
28-220-00
Full Arch
Chrome Plated28-221-00
Denture
Chrome Plated

28-222-00

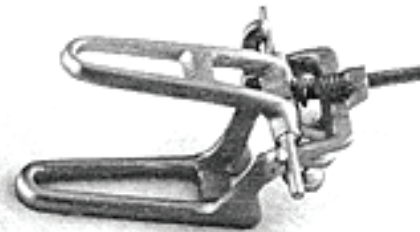
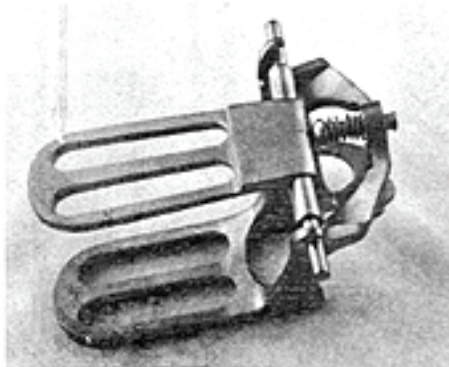
28-223-00
Crowned Bridge
Chrome Plated28-224-00
Full Denture
Chrome Plated

28-225-00

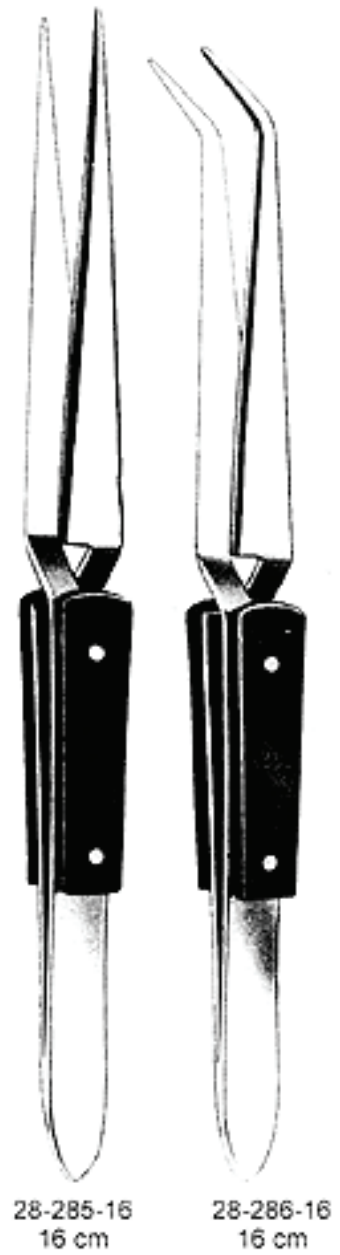
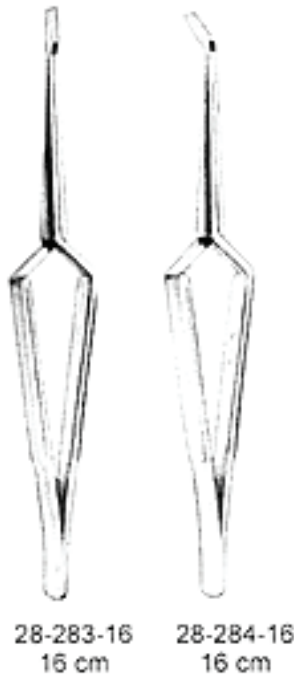
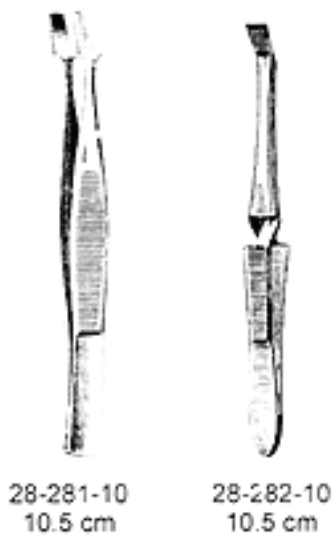
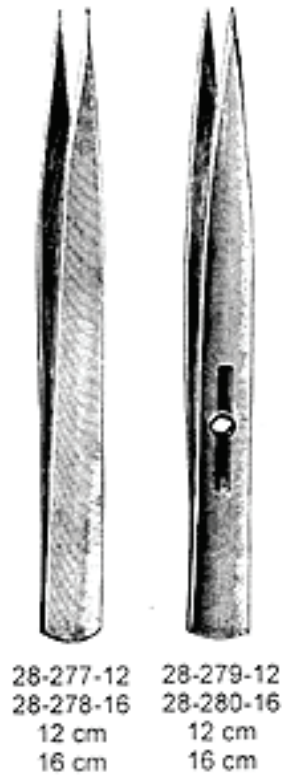
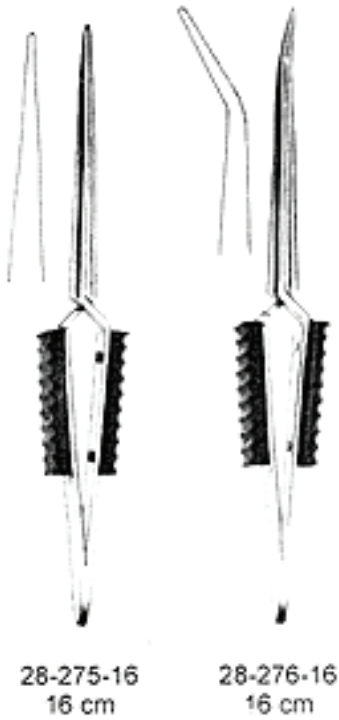

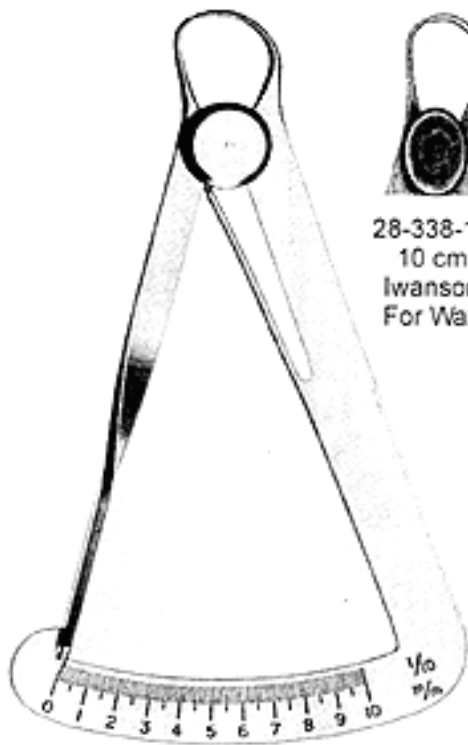

28-337-10
 10 cm
 Iwanson
 For Metal



28-338-10
 10 cm
 Iwanson
 For Wax



28-339-00



28-340-00
 Boley



28 341-00



28-342-00
Beerendonk



28-343-00

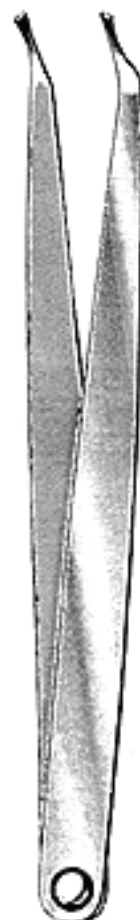

28-344-00
Korbit

Department

29

STAINLESS STEEL IMPRESSION TRAYS
ABDRUCKLOFFEL AUS EDELSTAHL
CUBETAS PARA DE ACERO INOXIDABLE

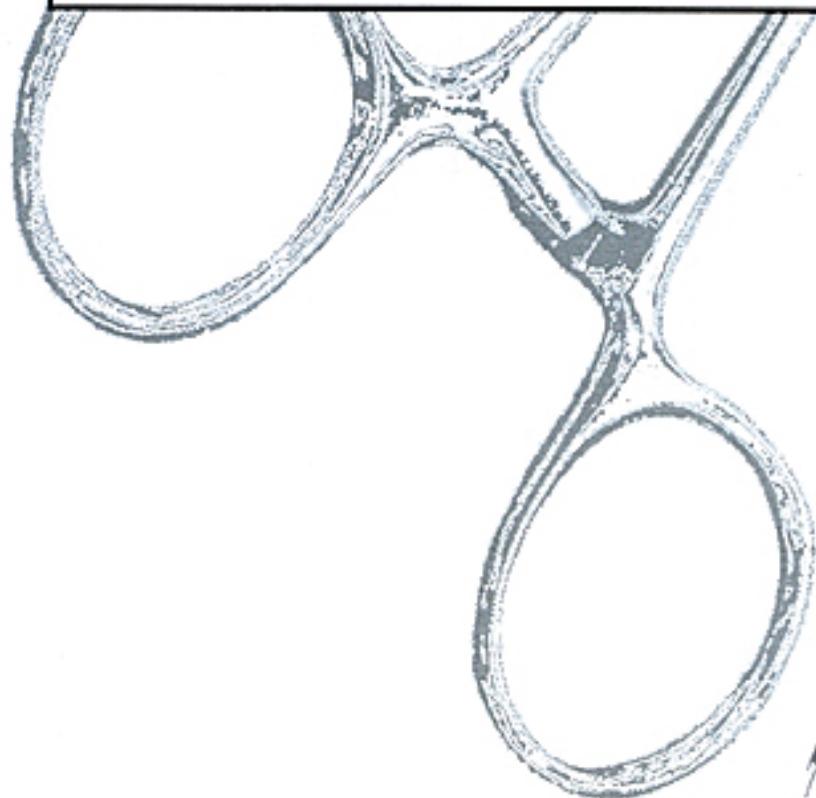
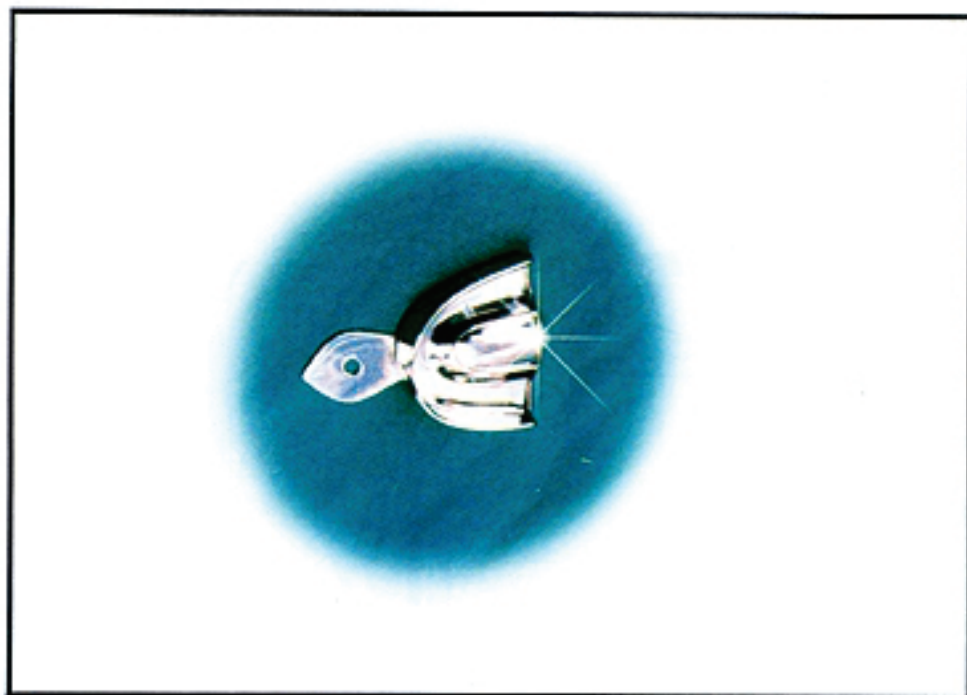

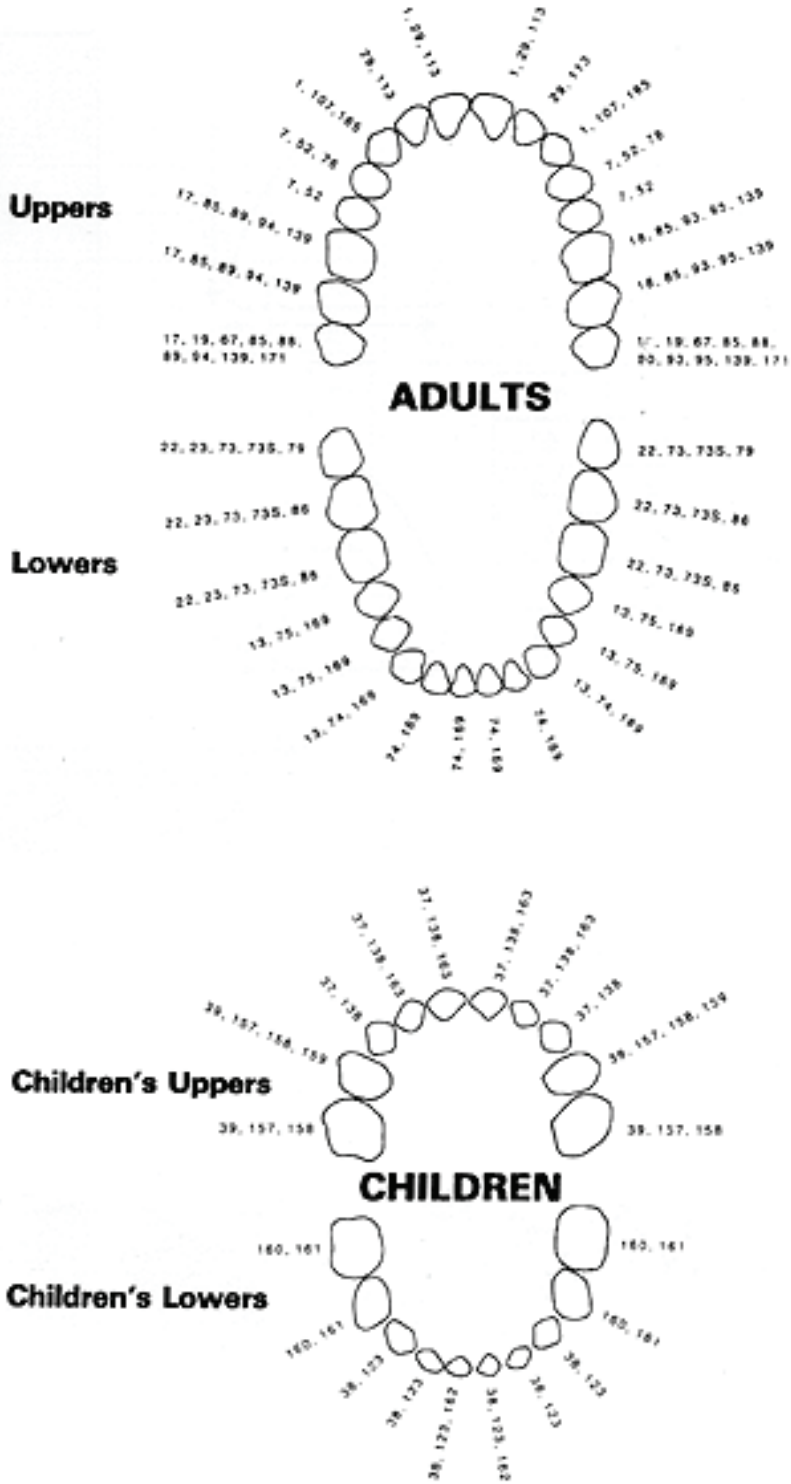



SUPER (Rim Lock)

29-001-00

► Set of 10 pieces

Numbers	Size	mm.	mm.
29-001-U1	XL	81	63
29-002-U2	L	74	60
29-003-U3	M	71	55
29-004-U5	NM	67	53
29-005-U4	S	65	51

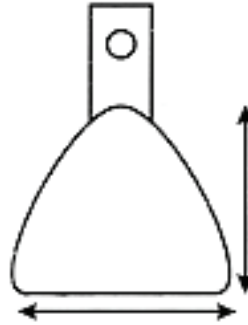

Numbers	Size	mm.	mm.
29-006-L1	XL	80	63
29-007-L2	L	78	59
29-008-L3	M	76	57
29-009-L4	NM	72	57
29-010-L5	S	69	50

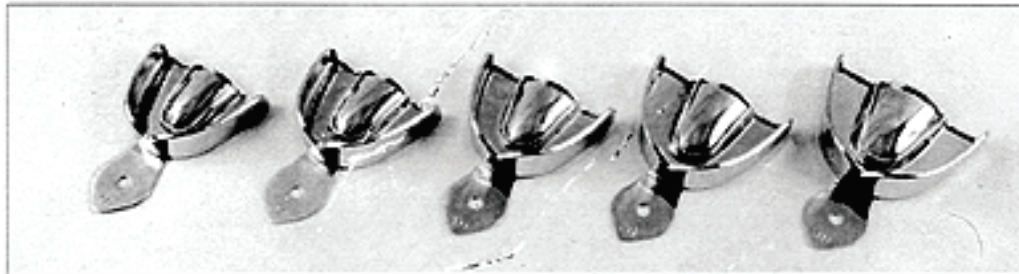
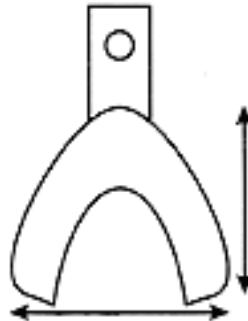

29-005-U5 29-004-U4 29-003-U3 29-002-U2 29-001-U1

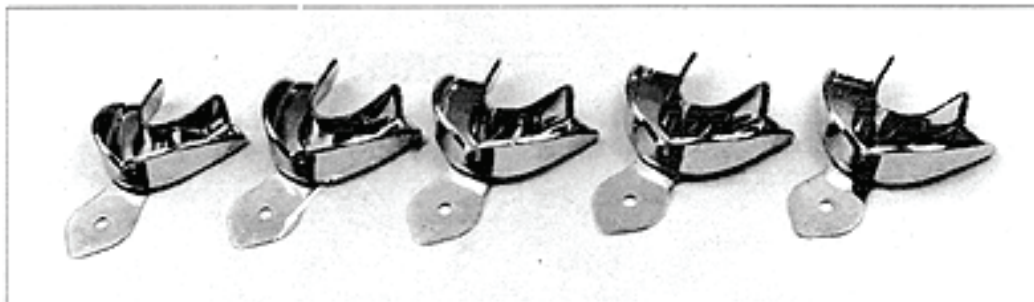

29-010-L5 29-009-L4 29-008-L3 29-007-L2 29-006-L1



29-002-00

→ Set of 10 pieces

REGULAR (Rim Lock)

Numbers	Size	mm.	mm.
29-011-U1	XXS	61	47
29-012-U2	XS	64	51
29-013-U3	S	66	53
29-014-U4	M	69	57
29-015-U5	L	71	60
29-015-U6	XL	73	62

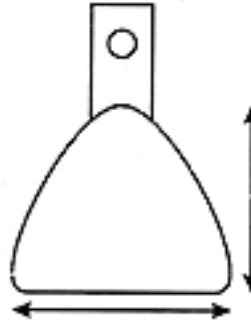

Numbers	Size	mm.	mm.
29-017-L1	XXS	55	47
29-018-L2	XS	60	49
29-019-L3	S	72	54
29-020-L4	M	75	57
29-021-L5	L	76	59
29-022-L6	XL	78	61

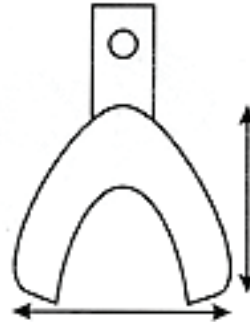

29-011-U1 29-012-U2 29-013-U3 29-014-U4 29-015-U5 29-016-U6



29-017-L1 29-018-L2 29-019-L3 29-020-L4 29-021-L5 29-022-L6



Crown and bridge work Impression trays STAINLESS STEEL

29-003-00

Set of 6 pieces

Number	Size
29-023-L6D	S
29-024-L4D	M
29-025-L2D	L
29-026-L6S	S
29-027-L4S	M
29-028-L2S	L



29-025-L2D
 29-024-L4D
 29-023-L6D

29-028-L2S
 29-027-L4S
 29-026-L6S

Number	Size
29-029-L1P	S
29-30-U1P	S

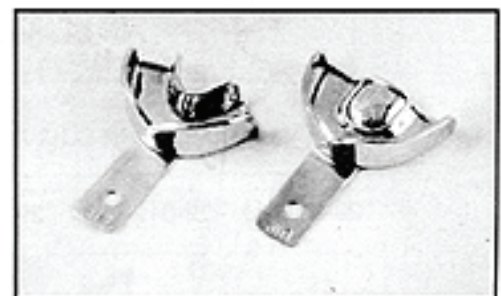

29-029-L1P 29- 30-U1P



29-004-44

Set of 12 Pieces (Without Rim Lock)

Numbers	Size	mm.	mm.
29-031-U1	XXS	61	47
29-032-U2	XS	64	51
29-033-U3	S	66	53
29-034-U4	M	69	57
29-035-U5	L	71	60
29-035-U6	XL	73	62

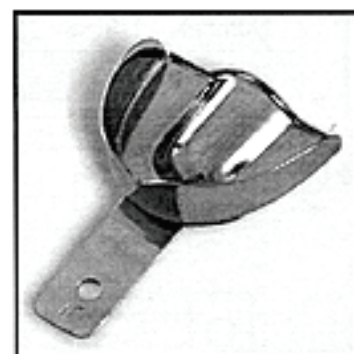
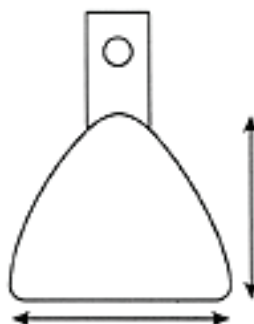

Numbers	Size	mm.	mm.
29-037-L1	XXS	65	47
29-038-L2	XS	60	49
29-039-L3	S	72	54
29-040-L4	M	74	57
29-041-L5	L	76	59
29-042-L6	XL	78	61

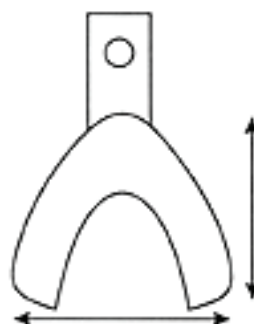

29-031-U1 29-032-U2 29-033-U3 29-034-U4 29-035-U5 29-035-U6



29-037-L1 29-038-L2 29-039-L3 29-040-L4 29-041-L5 29-042-L6



DEPRESSED ANTERIOR (Rim Lock)

29-005-00

Set of 6 pieces

Number	Size	mm.	mm.
29-043-U1	L	81	67
29-044-U4	M	71	64
29-045-U7	S	70	57

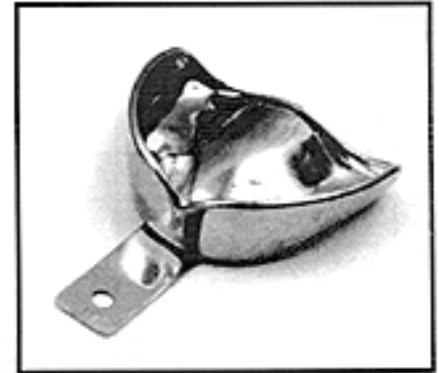
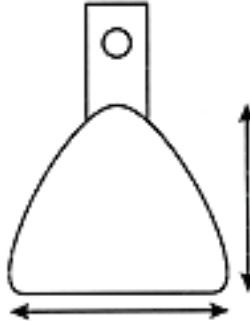

Number	Size	mm.	mm.
29-046-L20	L	81	60
29-047-L21	M	79	57
29-048-L22	S	76	54

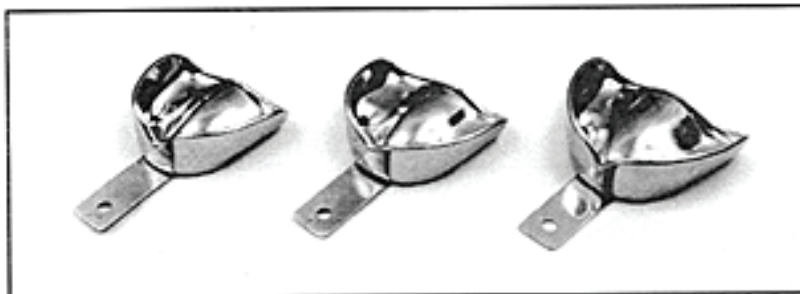
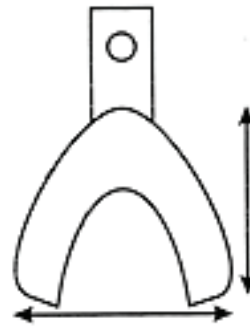

29-045-U7

29-044-U4

29-043-U1

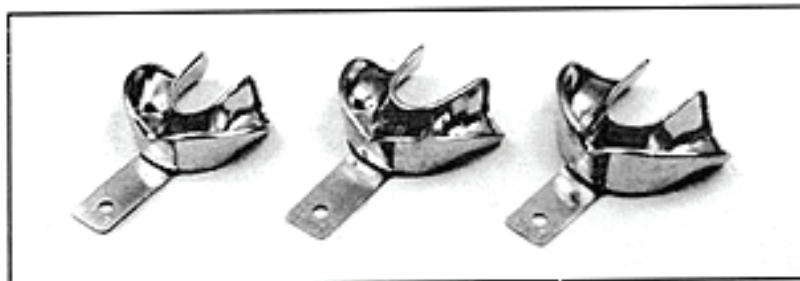

29-048-L22

29-047-L21

29-046-L20



DENTURE / EDENTOLOUS

29-006-00

Set of 8 pieces



Number	Size	mm.	mm.
29-049-U61	L	79	70
29-050-U62	M	76	67
29-051-U63	NM	70	64
29-052-U64	S	73	60

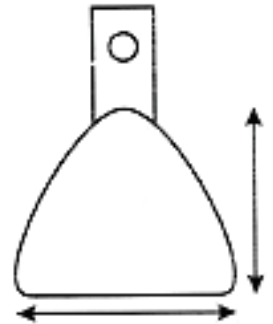

Number	Size	mm.	mm.
29-053-L66	L	86	64
29-054-L67	NL	70	64
29-055-L68	M	73	60
29-056-L69	S	70	57

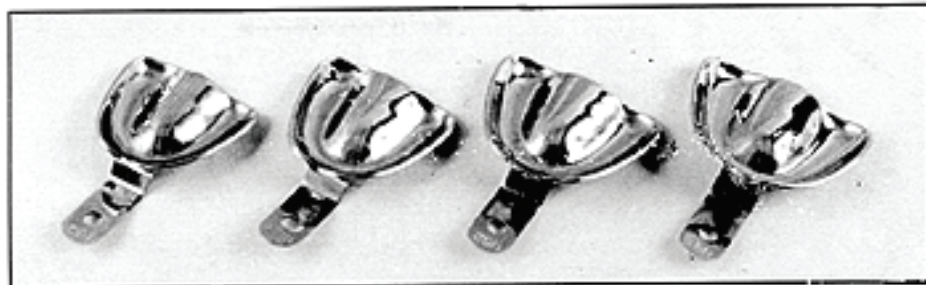
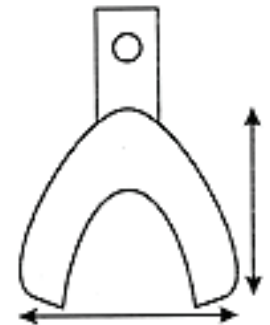

29-052-U64 29-051-U63 29-050-U62 29-049-U61

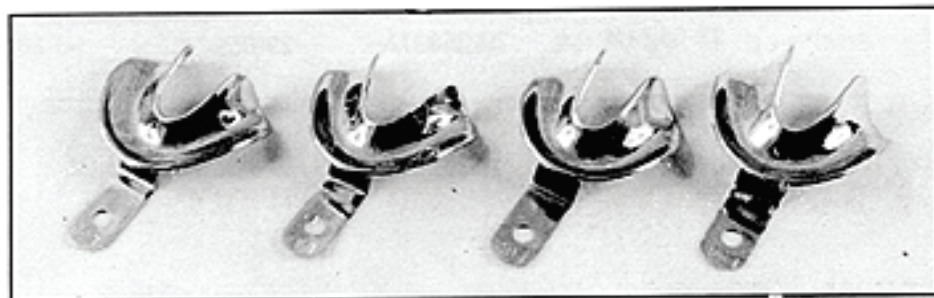

29-056-L69 29-055-L68 29-054-L67 29-053-L66



REGULAR (Rim Lock)

29-007-44
 Set of 6 Pieces

UPPER

Numbers	Size	mm.	mm.
29-057-U1	S	55	41
29-058-U2	M	62	46
29-059-U3	L	63	48

LOWER

Numbers	Size	mm.	mm.
29-060-L1	S	55	44
29-061-L2	M	63	52
29-062-L3	L	69	56

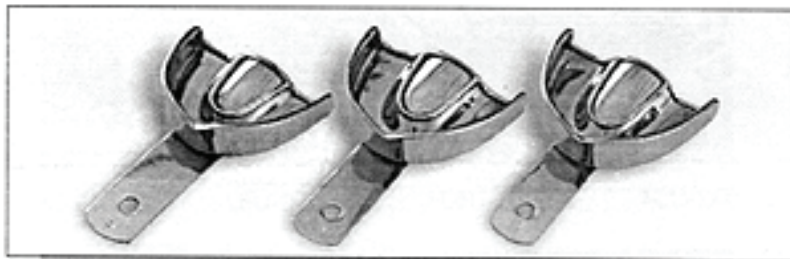
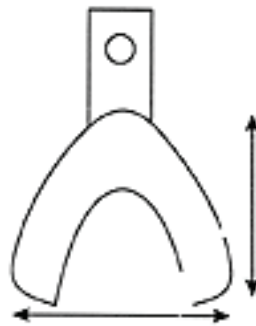
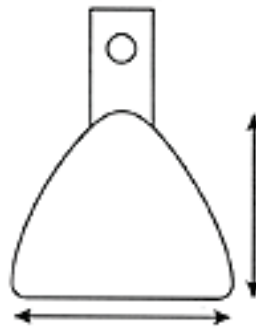

29-057-U1

29-058-U2

29-059-U3



29-060-L1

29-061-L2

29-062-L3



SUPPER (Rim Lock)

29-008-44
Set of 10 Pieces

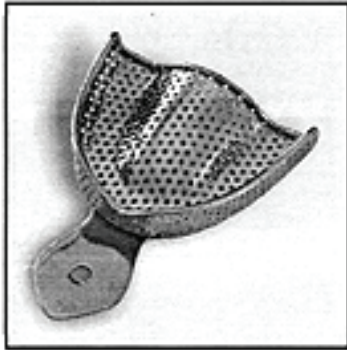

Numbers	Size	mm.	mm.
29-166-U1	XL	81	63
29-167-U2	L	74	60
29-168-U3	M	71	55
29-169-U4	NM	67	53
29-170-U5	S	65	51

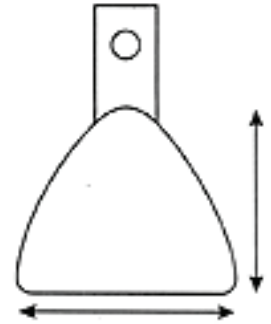

Numbers	Size	mm.	mm.
29-171-L1	XL	80	63
29-172-L2	L	78	59
29-173-L3	M	76	57
29-174-L4	NM	72	57
29-175-L5	S	69	50

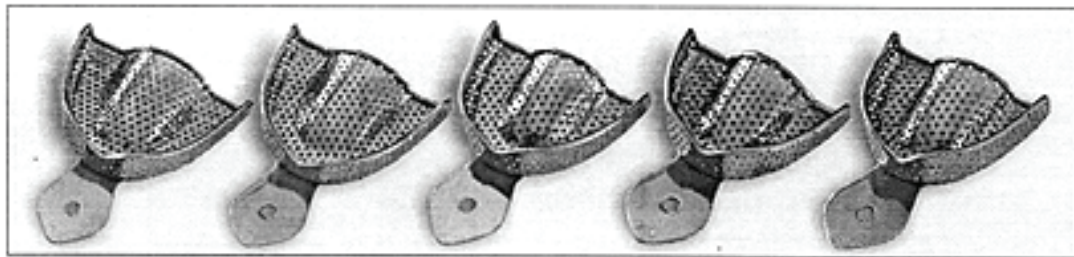
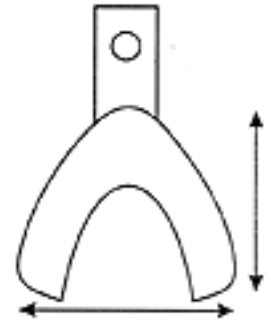

29-166-U1 29-167-U2 29-168-U3 29-169-U4 29-170-U5

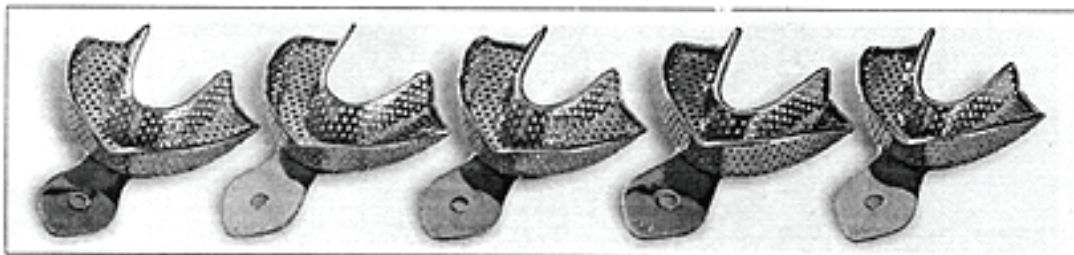

29-171-L1 29-172-L2 29-173-L3 29-174-L4 29-175-L5



REGULAR (Rim Lock)

29-009-44
 Set of 6 Pieces

UPPER

Numbers	Size	mm.	mm.
29-176-U1	S	55	41
29-177-U2	M	62	46
29-178-U3	L	63	48

LOWER

Numbers	Size	mm.	mm.
29-179-L1	S	55	44
29-180-L2	M	63	52
29-181-L3	L	69	56

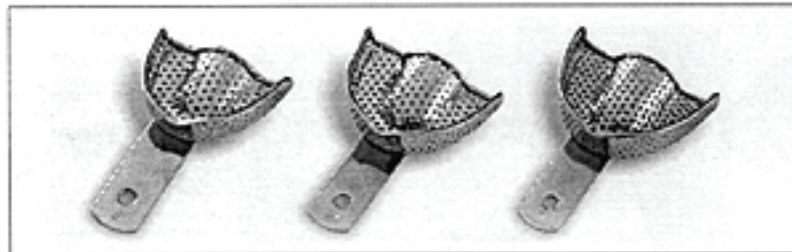
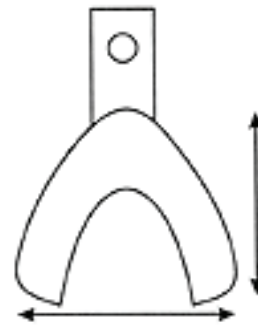
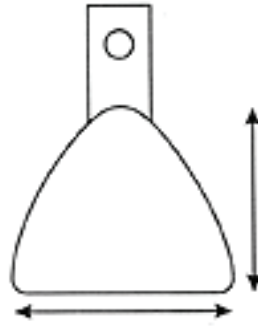

29-176-U1

29-177-U2

29-178-U3

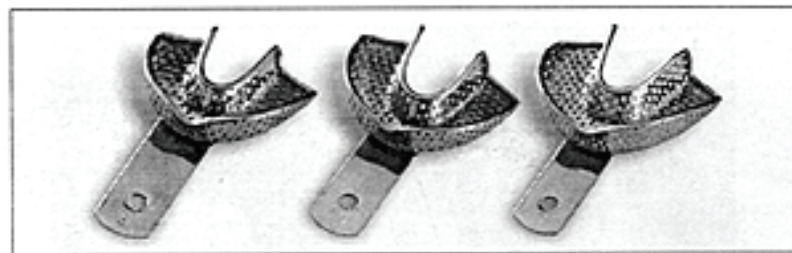

29-179-L1

29-180-L2

29-181-L3



REGULAR (Rim Lock)

29-010-00

Set of 12 Pieces



Numbers	Size	mm.	mm.
29-087-U1	XXS	61	47
29-088-U2	XS	64	51
29-089-U3	S	66	53
29-090-U4	M	69	57
29-091-U5	L	71	60
29-092-U6	XL	73	62

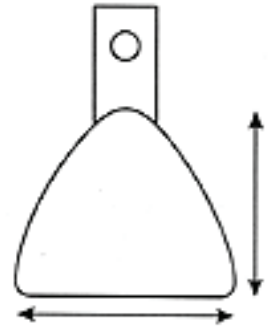

Numbers	Size	mm.	mm.
29-093-L1	XXS	55	47
29-094-L2	XS	60	49
29-095-L3	S	72	54
29-096-L4	M	75	57
29-097-L5	L	76	59
29-098-L6	XL	78	61

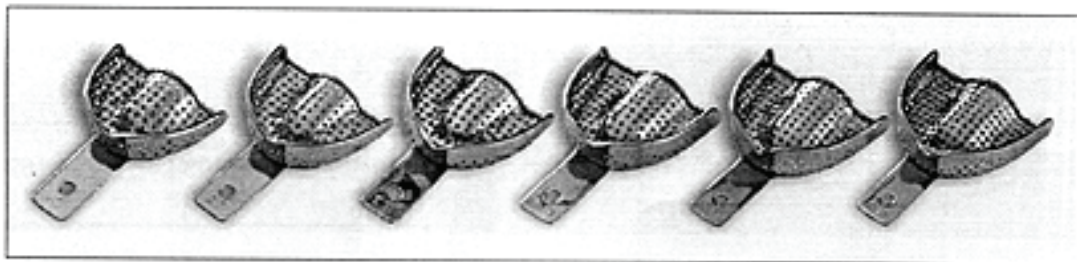
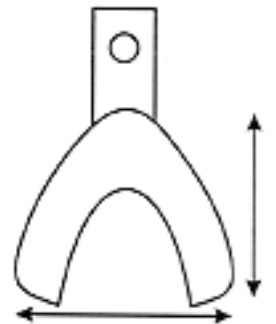

29-087-U1 29-088-U2 29-089-U3 29-090-U4 29-091-U5 29-092-U6

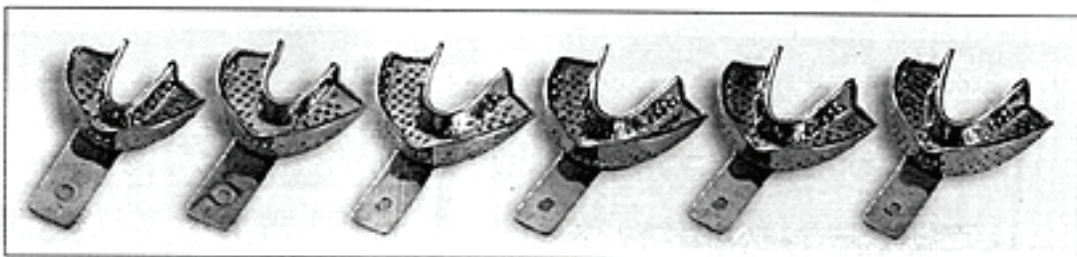

29-093-L1 29-094-L2 29-095-L3 29-096-L4 29-097-L5 29-098-L6



Crown and bridge work Impression trays

STAINLESS STEEL

29-011-00

►Set of 6 pieces

Number	Size
29-099-L6D	L
29-100-L4D	M
29-101-L2D	S

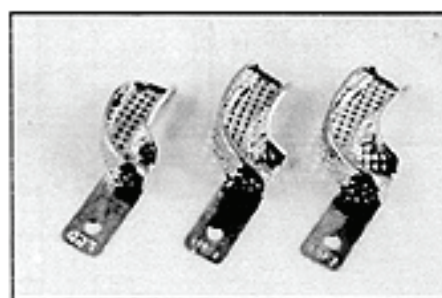

29-101-L2D 29-100-L4D 29-099-L6D

Number	Size
29-102-L6S	L
29-103-L4S	M
29-104-L2S	S

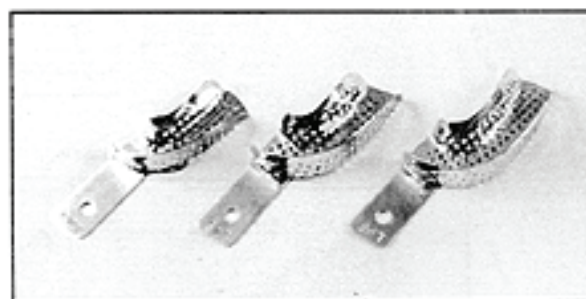

29-104-L2S 29-103-L4S 29-102-L6S

Number	Model
29-030-U1P	UPPER
29-031-L1P	LOWER

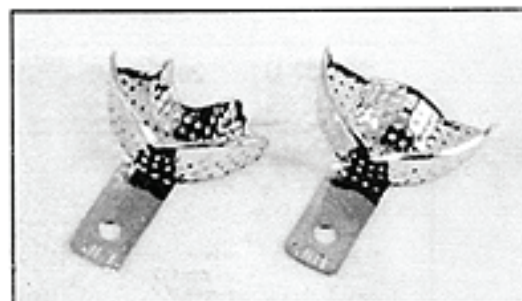

29-106-U1P 29-105-L1P



29-012-00

→ Set of 12 Pieces (Without Rim Lock)



Numbers	Size	mm.	mm.
29-107-U1	XXS	61	47
29-108-U2	XS	64	51
29-109-U3	S	66	53
29-110-U4	M	69	57
29-111-U5	L	71	60
29-112-U6	XL	73	62

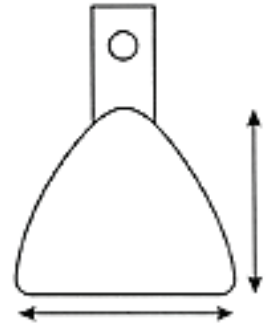

Numbers	Size	mm.	mm.
29-113-L1	XXS	55	47
29-114-L2	XS	60	49
29-115-L3	S	72	54
29-116-L4	M	75	57
29-117-L5	L	76	59
29-118-L6	XL	78	61

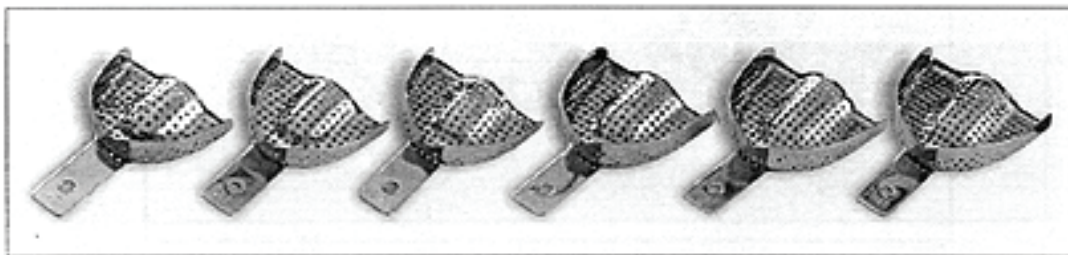
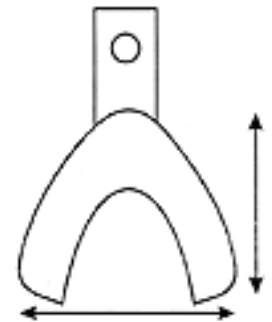

29-107-U1 29-108-U2 29-109-U3 29-110-U4 29-111-U5 29-112-U6



29-113-L1 29-114-L2 29-115-L3 29-116-L4 29-117-L5 29-118-L6



DEPRESSED ANTERIOR (Rim Lock)

29-013-00

Set of 6 pieces

Numbers	Size	mm.	mm.
29-119-U7	L	81	67
29-120-U4	M	71	64
29-121-U1	S	70	57

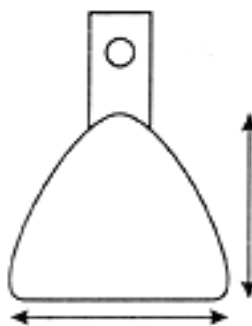

Numbers	Size	mm.	mm.
29-122-L22	L	81	60
29-123-L21	M	79	57
29-124-L20	S	76	54

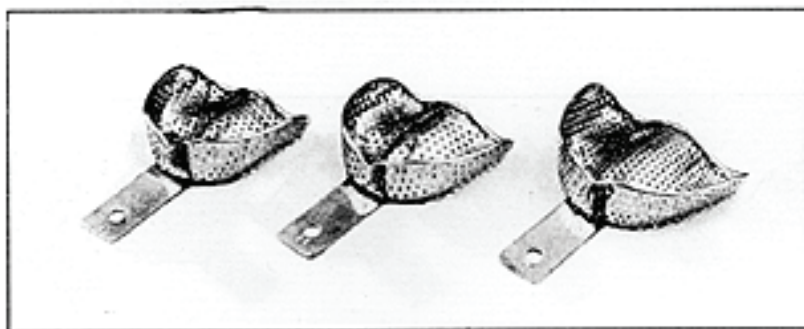
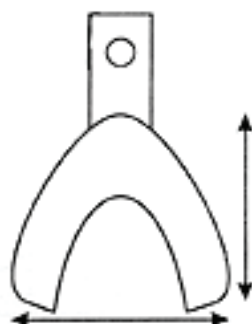

29-121-U1 29-120-U4 29-119-U7

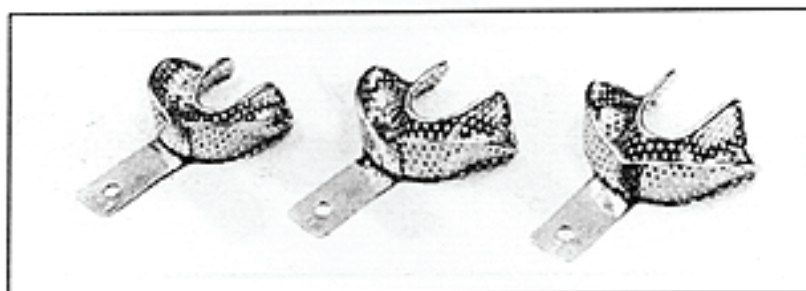

29-124-L20 29-123-L21 29-122-L22



DENTURE / EDENTOLOUS



29-014-00
 Set of 8 pieces

Numbers	Size	mm.	mm.
29-125-U64	L	79	70
29-126-U63	M	76	67
29-127-U62	NM	70	64
29-128-U61	S	73	60

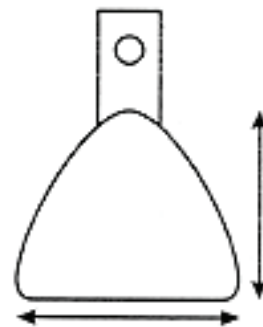

Numbers	Size	mm.	mm.
29-129-L69	L	86	64
29-130-L68	NL	73	60
29-131-L67	M	70	64
29-132-L66	S	70	57

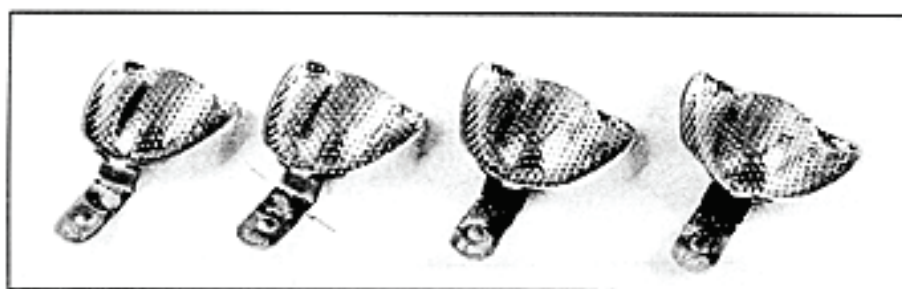
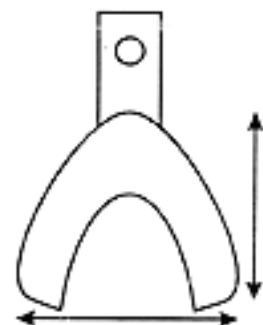

29-128-U61 29-127-U62 29-126-U63 29-125-U64



29-132-L66 29-131-L67 29-130-L68 29-129-L69



EHRICKE (Non Perforated)

Numbers	Size
29-185-UO1	UO1
29-186-UO2	UO2
29-187-UO3	UO3



Numbers	Size
29-188-UU1	UU1
29-189-UU2	UU2
29-190-UU3	UU3



Numbers	Size
29-191-BO0	BO0
29-192-BO1	BO1
29-193-BO2	BO2
29-194-BO3	BO3
29-195-BO4	BO4



Numbers	Size
29-196-BU0	BU0
29-197-BU1	BU1
29-198-BU2	BU2
29-199-BU3	BU3
29-200-BU4	BU4

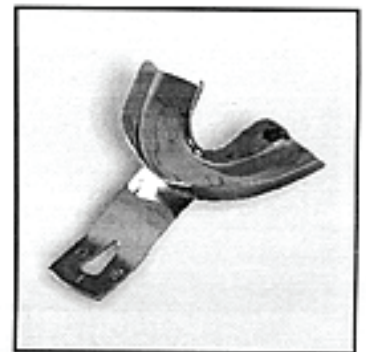

Numbers	Size
29-201-PO1	PO1
29-202-PO2	PO2
29-203-PO3	PO3



Numbers	Size
29-204-PU1	PU1
29-205-PU2	PU2
29-206-PU3	PU3





EHRICKE (Perforated)

Numbers	Size
29-207-UO1	UO1
29-208-UO2	UO2
29-209-UO3	UO3



Numbers	Size
29-210-UU1	UU1
29-211-UU2	UU2
29-212-UU3	UU3



Numbers	Size
29-213-BO0	BO0
29-214-BO1	BO1
29-215-BO2	BO2
29-216-BO3	BO3
29-217-BO4	BO4



Numbers	Size
29-218-BU0	BU0
29-219-BU1	BU1
29-220-BU2	BU2
29-221-BU3	BU3
29-222-BU4	BU4



Numbers	Size
29-223-PO1	PO1
29-224-PO2	PO2
29-225-PO3	PO3



Numbers	Size
29-226-PU1	PU1
29-227-PU2	PU2
29-228-PU3	PU3



STAINLESS STEEL IMPRESSION TRAYS
 ABDRUCKLOFFEL AUS EDELSTAHL
 CUBETAS PARA DE ACERO INOXIDABLE



NEW

EDENTULOUS

29-018-44

Set of 11 Pieces (Without Rim Lock)

Numbers	Size	mm.	mm.
29-230-U1	XXS	60	50
29-231-U2	XS	64	54
29-232-U3	S	68	58
29-233-U4	M	70	60
29-234-U5	L	78	64

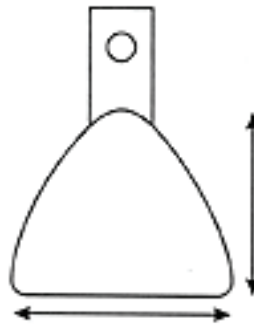

Numbers	Size	mm.	mm.
29-235-L1	XXS	60	54
29-236-L2	XS	67	55
29-237-L3	S	70	56
29-238-L4	M	74	58
29-239-L5	L	76	60
29-240-L6	XL	80	62

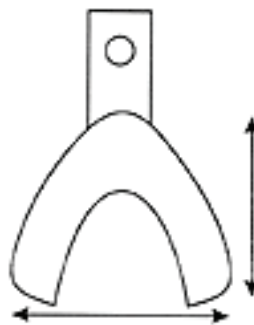

29-230-U1 29-231-U2 29-232-U3 29-233-U4 29-234-U5



29-235-L1 29-236-L2 29-237-L3 29-238-L4 29-239-L5 29-240-L6

Department

30

TRAYS AND BOWLS
TABLETEN UND BECHER
BANDEJAS PARA BUCALES

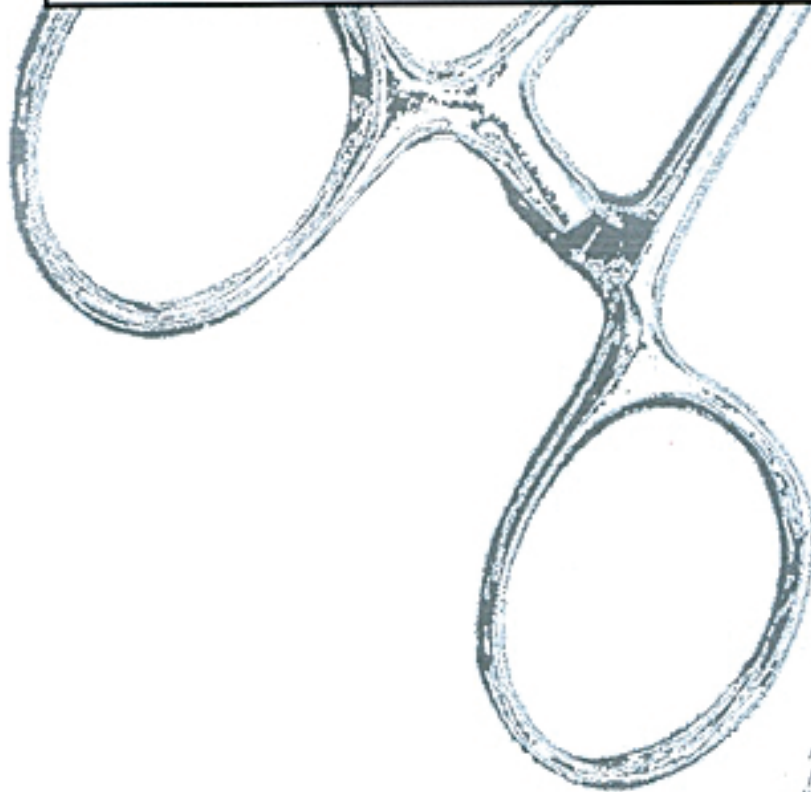
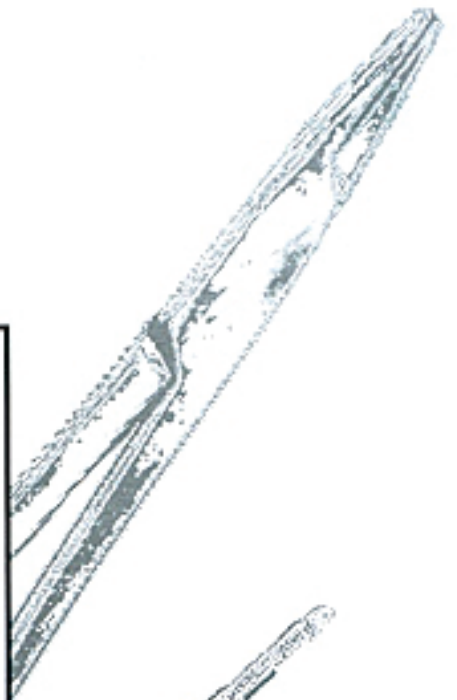

DEPARTMENT NO. 30

FROM
PAGE#

351

TO
PAGE#

359

INSTRUMENTS CATEGORY

TRAYS AND BOWLS
TABLETEN UND BECHER
BANDEJAS PARA BUCALES

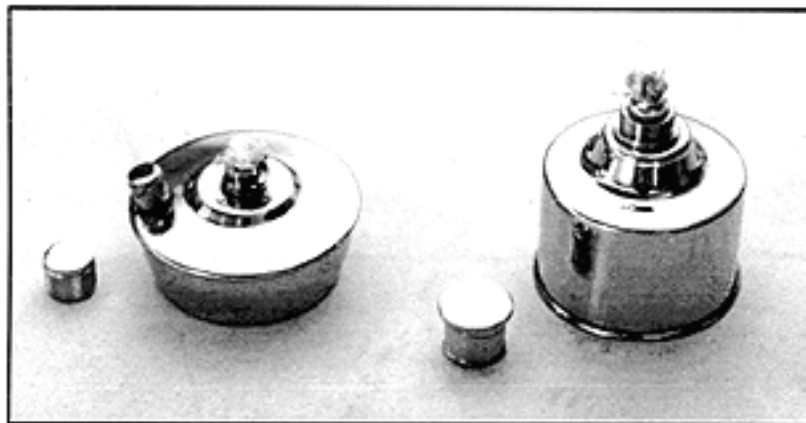

30-001-00
4 oz

30-002-00
4 oz
6 oz

TRAYS AND BOWLS
 TABLETEN UND BECHER
 BANDEJAS PARA BUCALES



30-003-10 (10 cm)
 30-004-12 (12 cm)
 30-005-15 (15 cm)
 30-006-20 (20 cm)
 30-007-25 (25 cm)
 Lotion Bowl

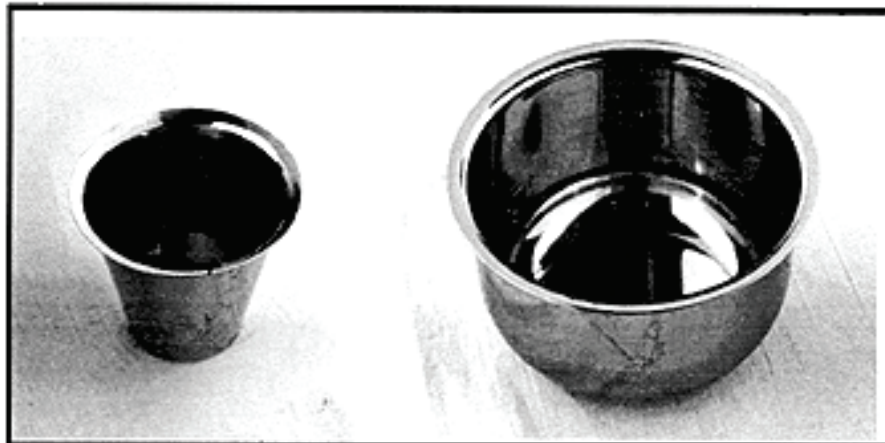
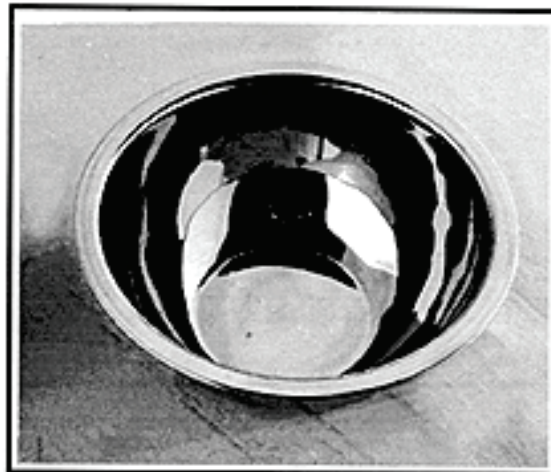

30-008-00 (50 cc)
 30-009-00 (100 cc)
 Medicine Cup

30-010-00 (80x50 mm)
 Iodine Cup



30-011-00
 Cotton Wool Holder

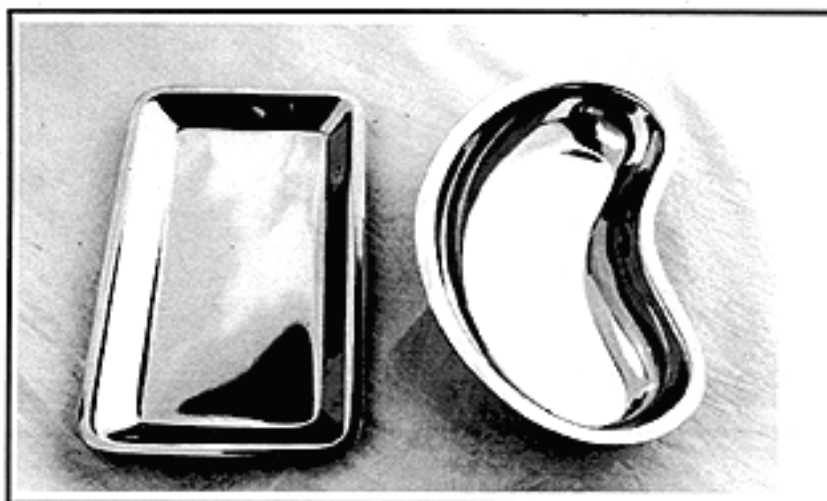

- | | L | W | H |
|-----------|------|------|--------|
| 30-012-00 | 9.2 | 5.4 | 1 cm |
| 30-013-00 | 15 | 10 | 1 cm |
| 30-014-00 | 18.5 | 10.5 | 1 cm |
| 30-015-00 | 19 | 10 | 1.5 cm |
| 30-016-00 | 20 | 10 | 1 cm |
| 30-017-00 | 20 | 15 | 1 cm |
| 30-018-00 | 25 | 15 | 1 cm |
| 30-019-00 | 28 | 19 | 2 cm |
| 30-020-00 | 29 | 19 | 1 cm |
- Instrument Tray

- 30-021-12 (12 cm)
 - 30-022-15 (15 cm)
 - 30-023-20 (20 cm)
 - 30-024-25 (25 cm)
 - 30-025-30 (30 cm)
- Kidney Tray

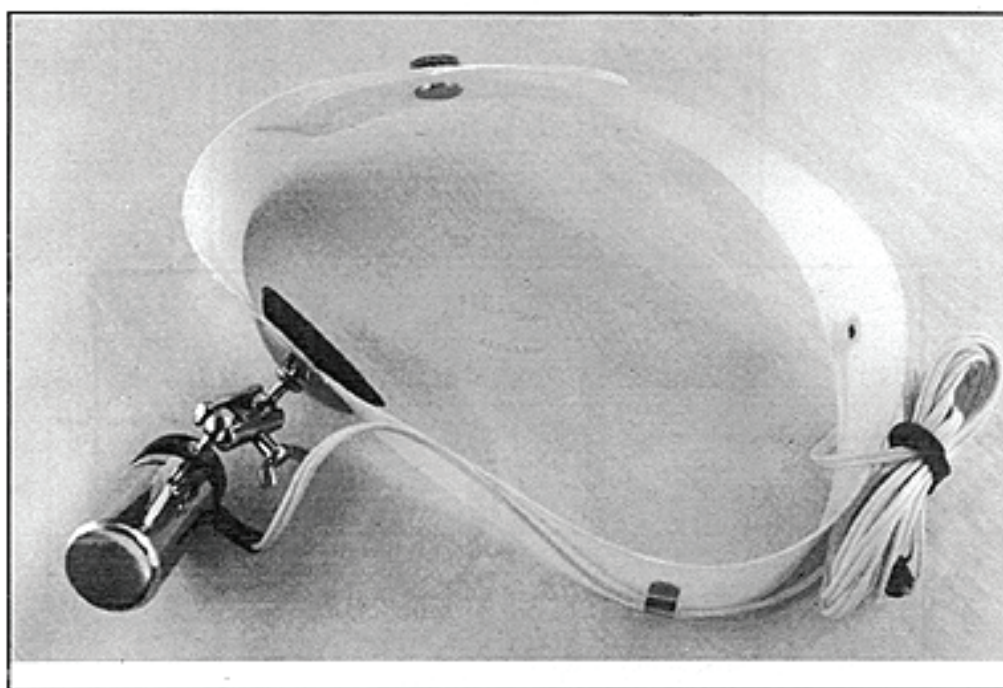

30-026-00
Mod. Matin

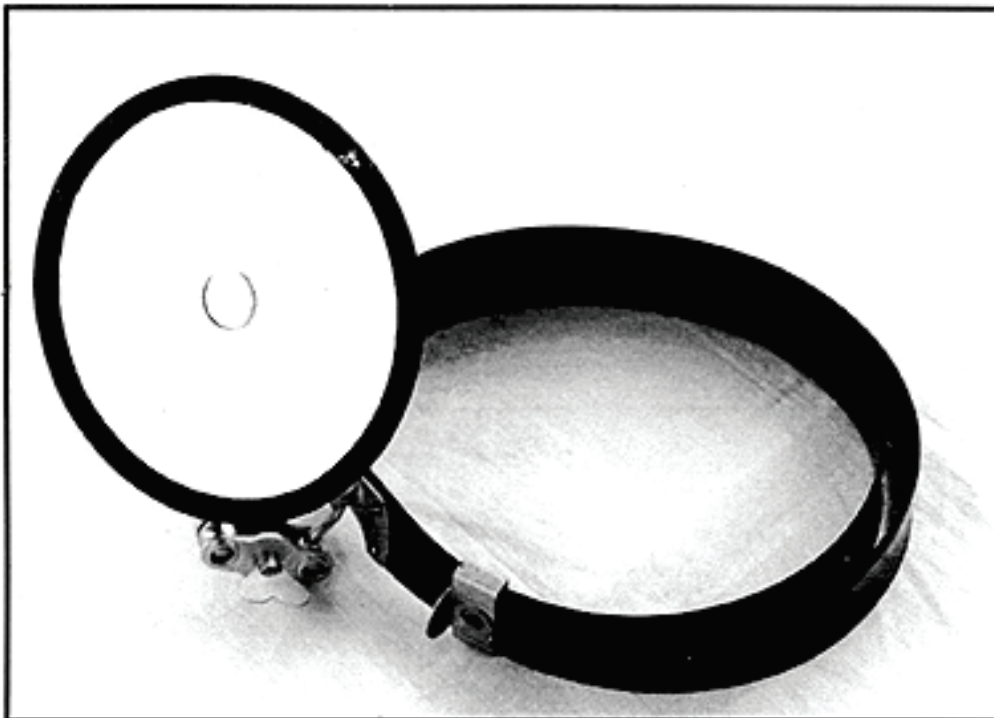

30-027-00
Head Mirrors

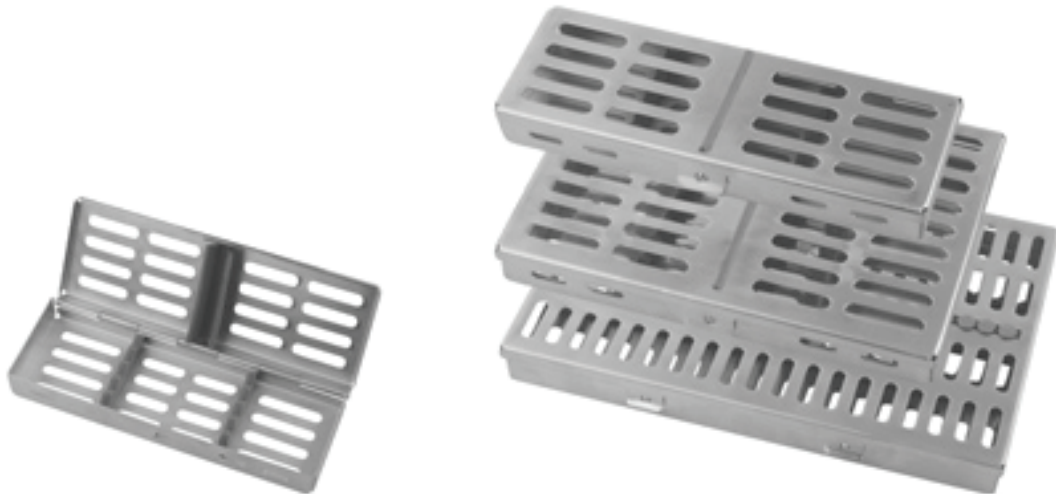
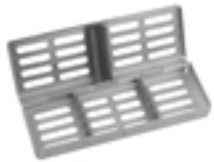

Cassette Trays with fixed lid

30-060-00	180 x 60 x 22 mm
30-061-00	180 x 140 x 22 mm
30-062-00	280 x 184 x 28 mm



Cassette Trays with detachable lid

30-065-00	180 x 70 x 35 mm
30-066-00	180 x 110 x 35 mm
30-067-00	180 x 145 x 35 mm
30-068-00	290 x 180 x 35 mm



Cassette Trays

30-070-00	180 x 60 x 20 mm
30-071-00	180 x 125 x 20 mm
30-072-00	200 x 140 x 30 mm



30-074-00 200 x 115 x 20 mm

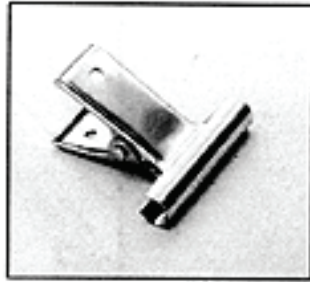

30-030-00
Film Holder

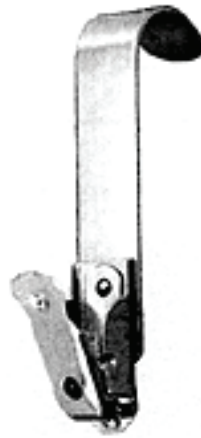

30-029-00
Radiography Clip

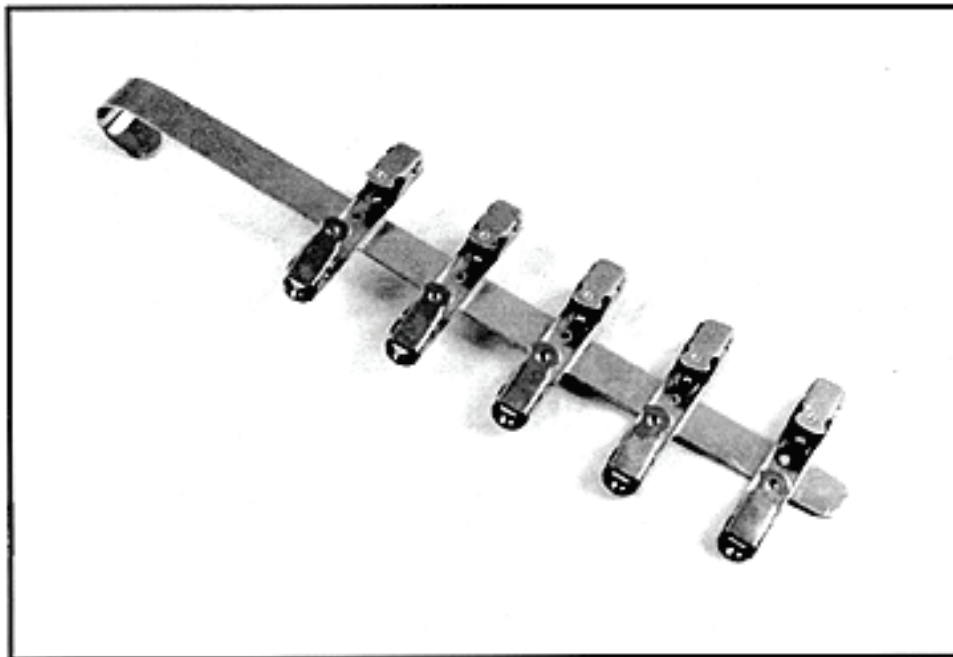

30-031-00 (With 14 Clips)
30-032-00 (With 10 Clips)
30-033-00 (With 6 Clips)
Film Hangers

Department

31

ORTHODONTICS PLIERS
ORTHODONTIE ZANGEN
ALICATES DE ORTODONCIA

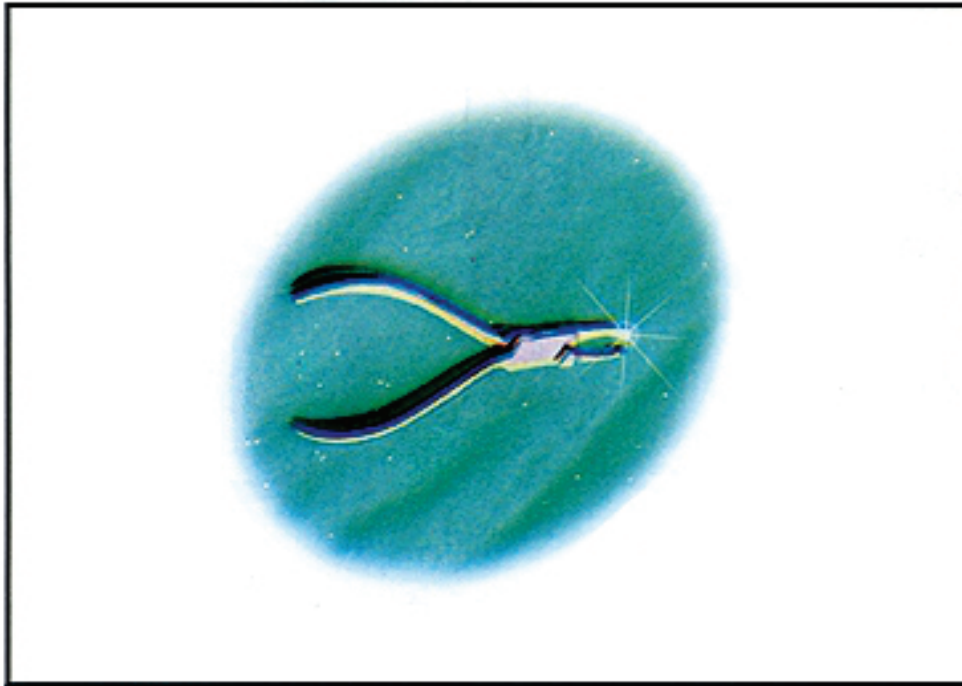
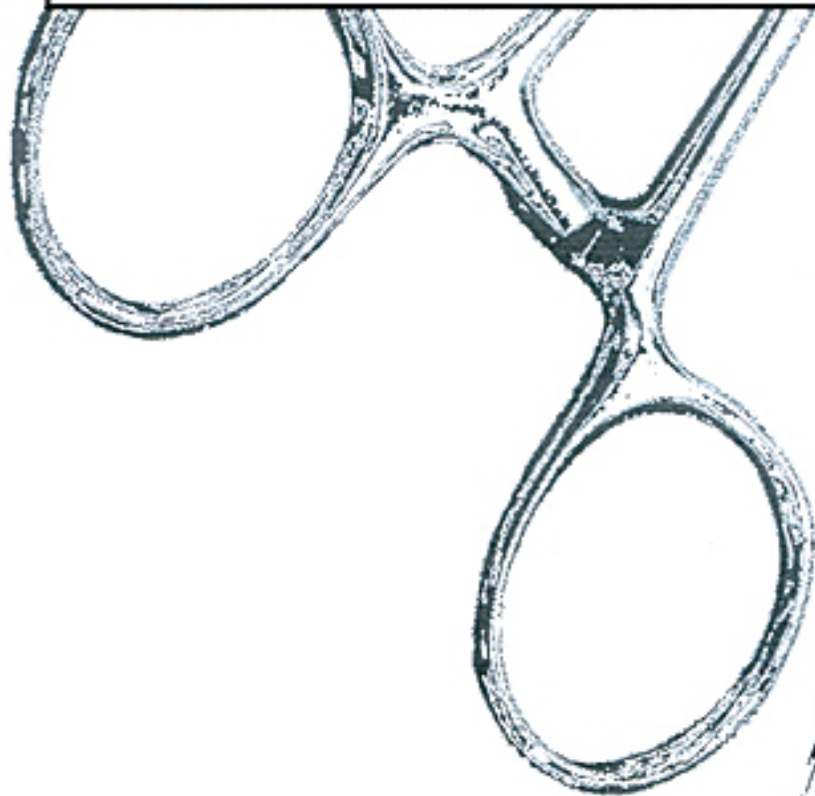

DEPARTMENT NO. 31

FROM
PAGE#

360

TO
PAGE#

375

INSTRUMENTS CATEGORY

ORTHODONTICS PLIERS
ORTHODONTIE ZANGEN
ALICATES DE ORTODONCIA

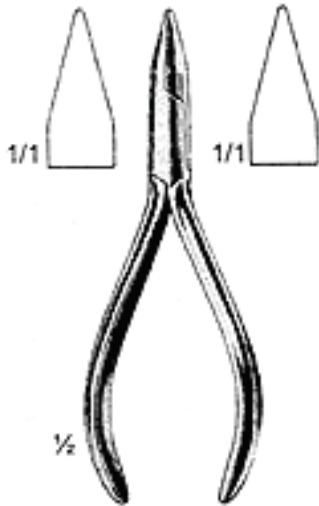

31-001-13
13.5 cm

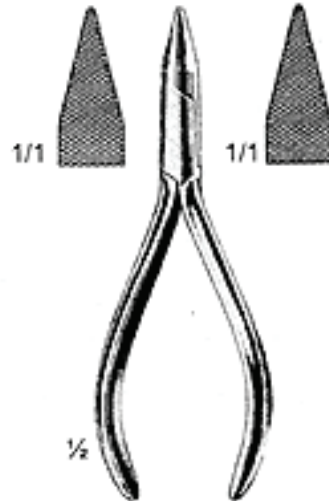

31-002-13
13.5 cm
Flat Nose Pliers

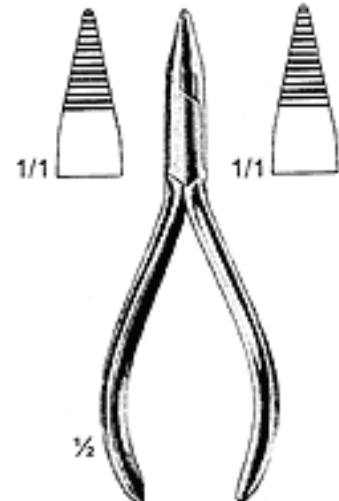

31-003-13
13.5 cm

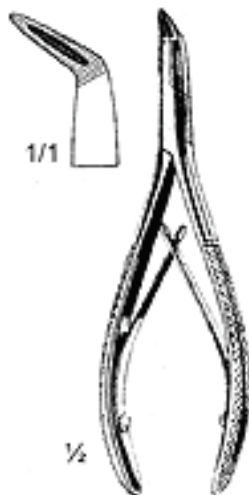

31-004-13
13.5 cm
Stieglitz

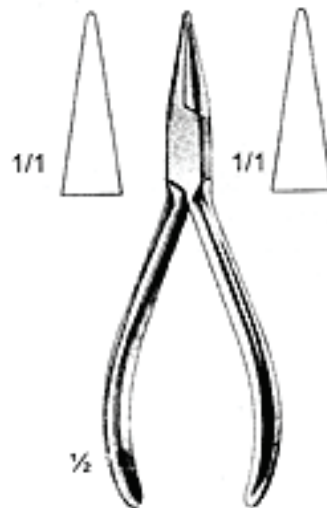

31-005-14
14 cm

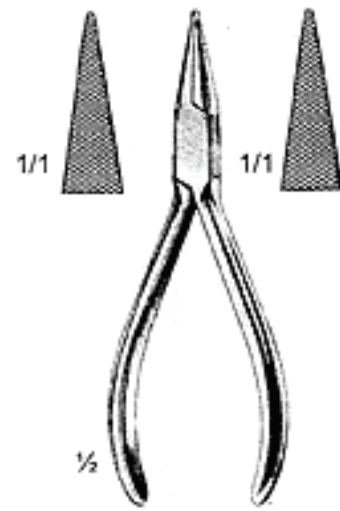

31-006-14
14 cm

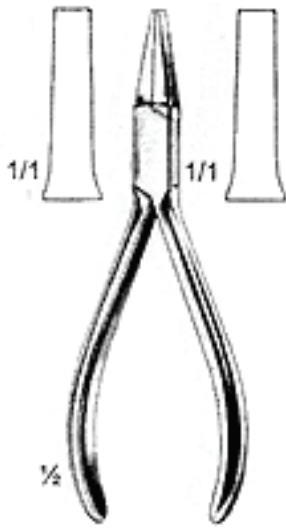

31-007-14
 14 cm

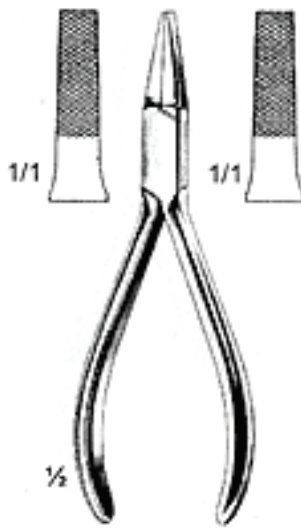

31-008-14
 14 cm

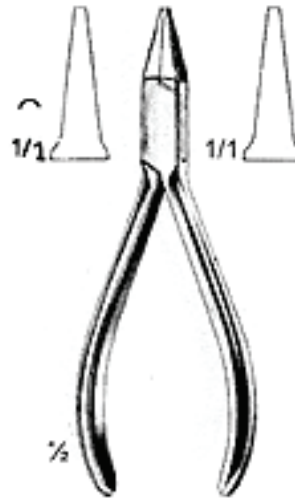

31-009-13
 13.5 cm

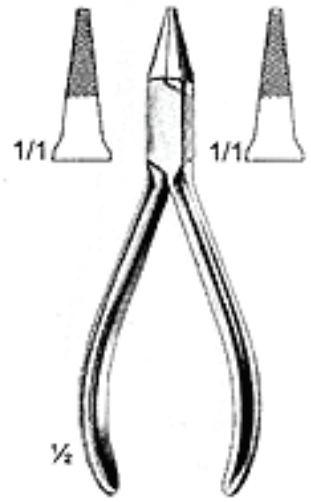

31-010-13
 13 cm

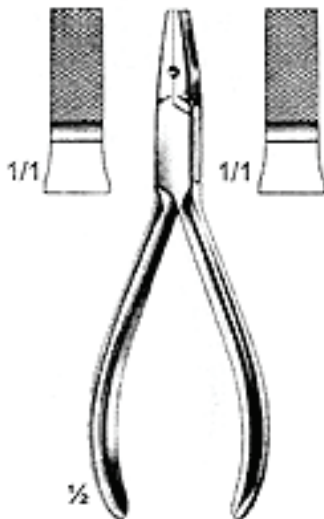

31-011-14
 14 cm

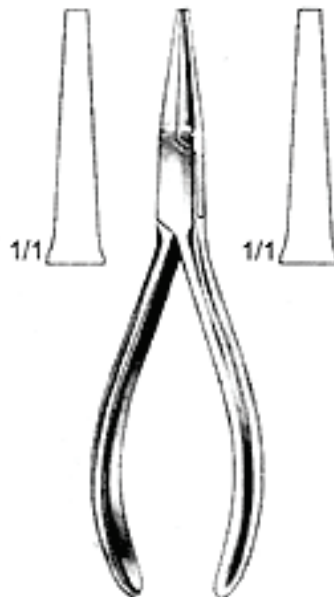

31-012-16
 16 cm

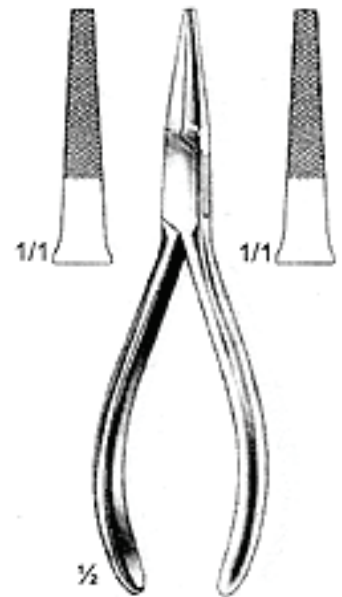

31-013-16
 16 cm

Langbeck

ORTHODONTICS PLIERS
 ORTHODONTIE ZANGEN
 ELICATES DE ORTODONCIA

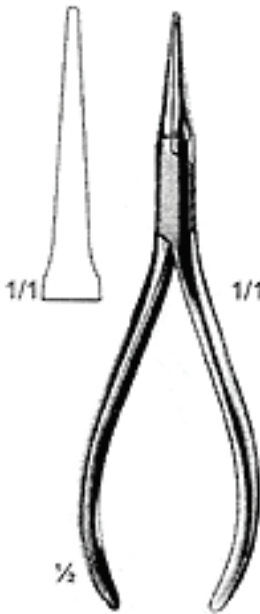
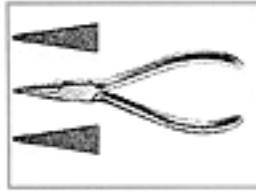

31-014-16
 16.5 cm

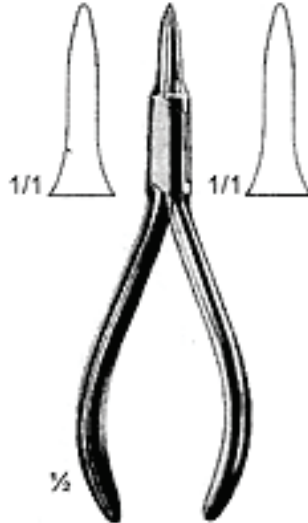

31-015-14
 14 cm

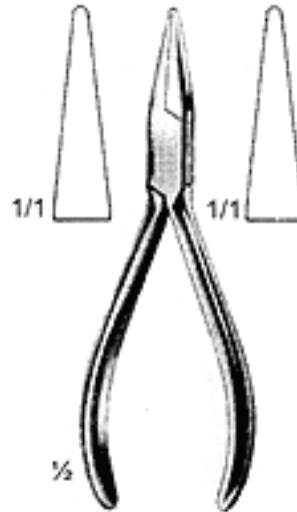

31-016-14
 14 cm

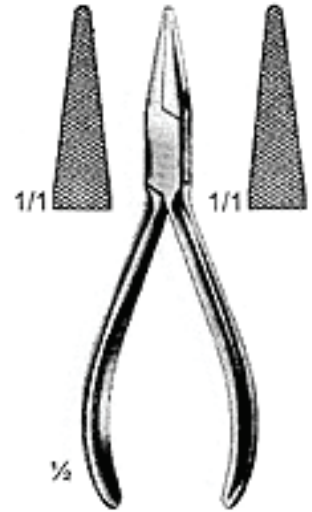

31-017-14
 14 cm

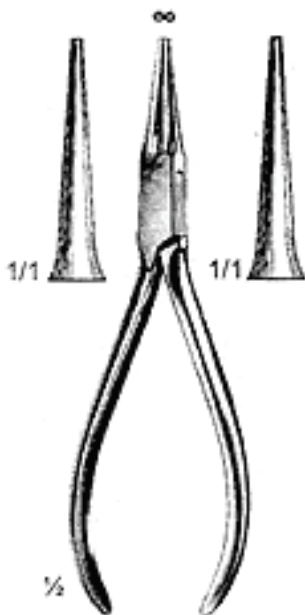

31-018-15
 15.5 cm

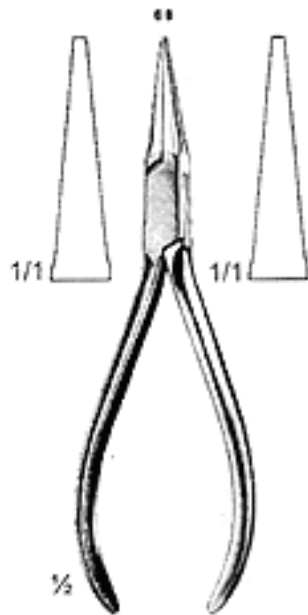

31-019-15
 15.5 cm

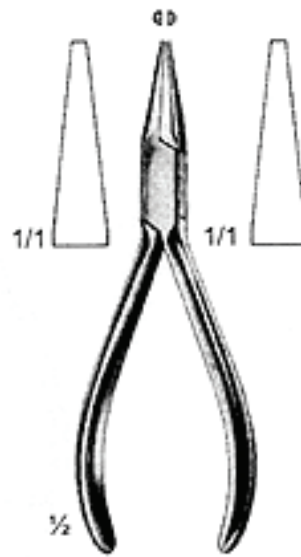

31-020-14
 14 cm

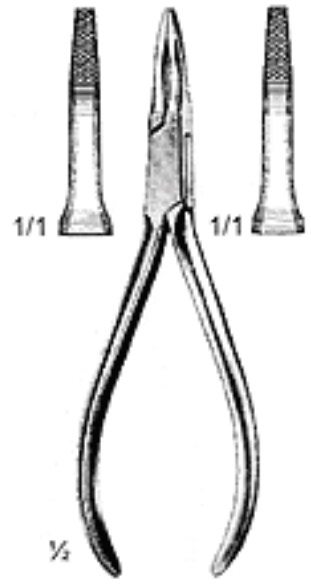

31-021-15
 15.5 cm
 Fischer

Langbeck

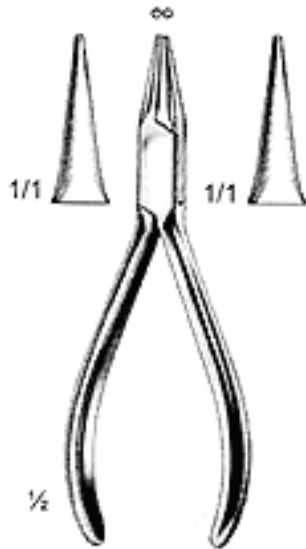

31-022-14
 14 cm

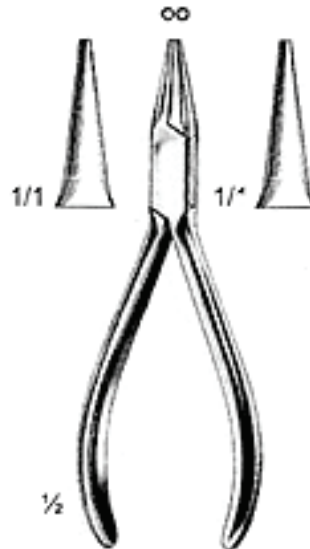

31-023-14
 14 cm
 Round Nose Pliers

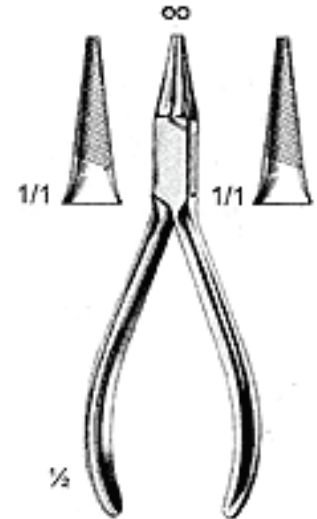

31-024-14
 14 cm

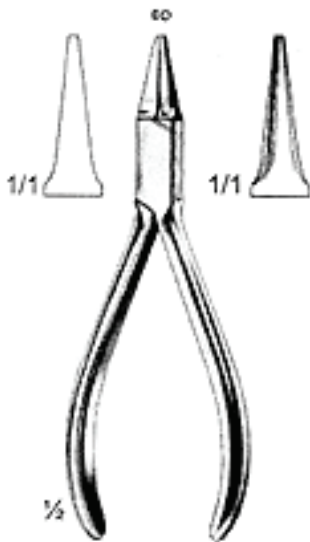

31-025-14
 14 cm



31-026-13
 13 cm



31-027-13
 13 cm

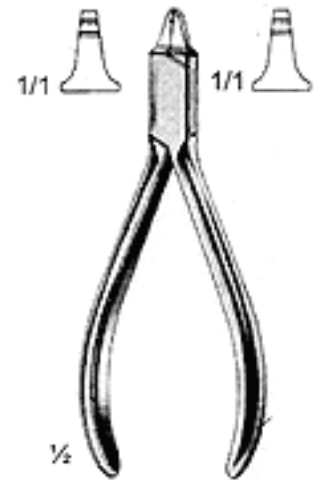

305
 31-028-13
 13 cm
 Oliver

Angle

ORTHODONTICS PLIERS
 ORTHODONTIE ZANGEN
 ELICATES DE ORTODONCIA

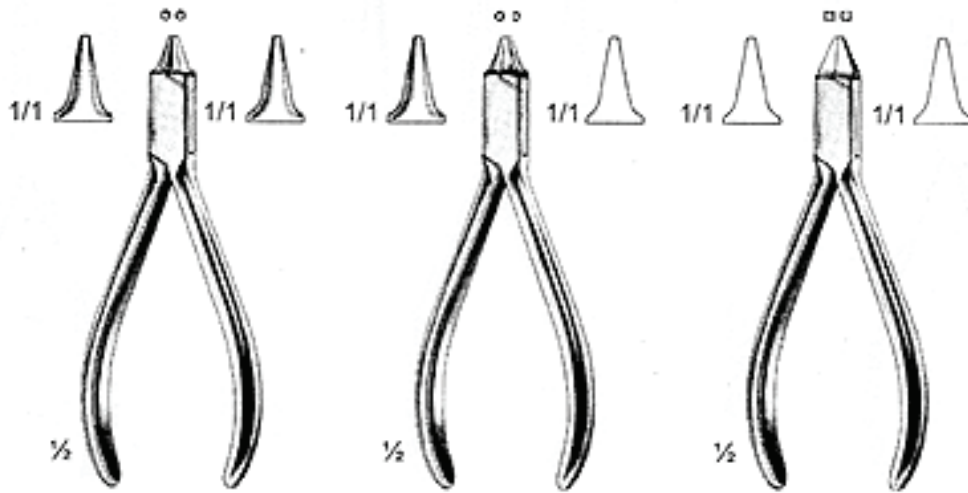
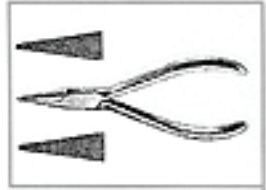

31-029-12.5
 12.5 cm

139
 31-030-12.5
 12.5 cm
 Angle

31-031-12.5
 12.5 cm
 Adams

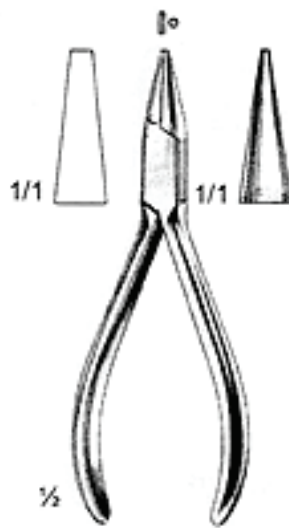

31-032-13
 13 cm

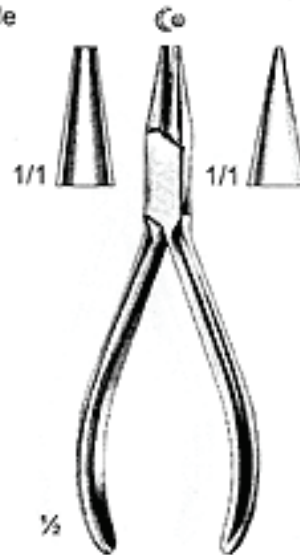

31-033-14
 14 cm
 Schwarz

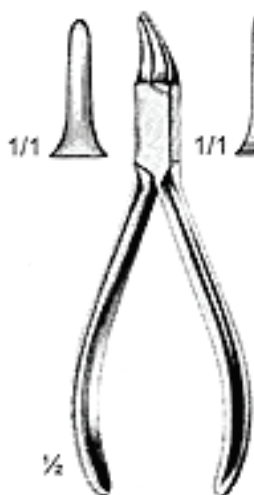

137
 31-034-13
 13.5 cm
 Gordon



31-035-13
 13.5 cm
 USA Modell

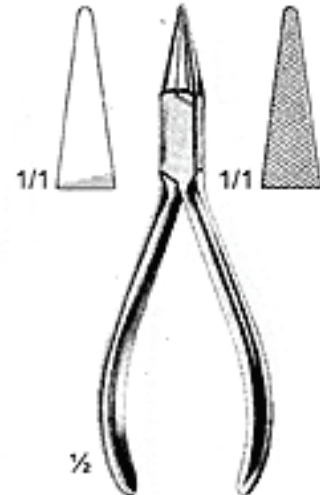

136
 31-036-13
 13.5 cm
 Goslee

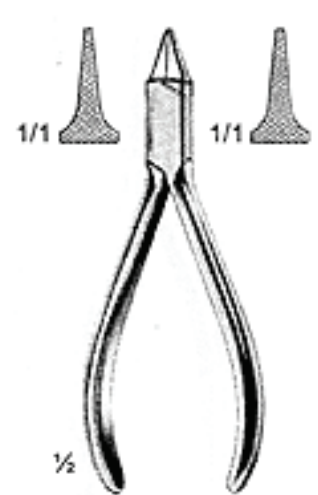

31-037-13
 13 cm
 Frevert

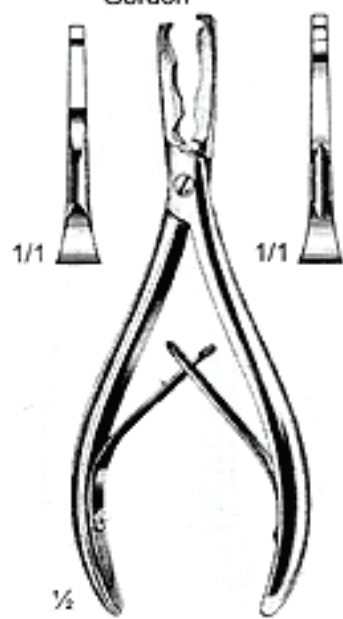

31-038-16
 16.5 cm
 Tryfus



114
 31-039-12
 12 cm
 Johnson

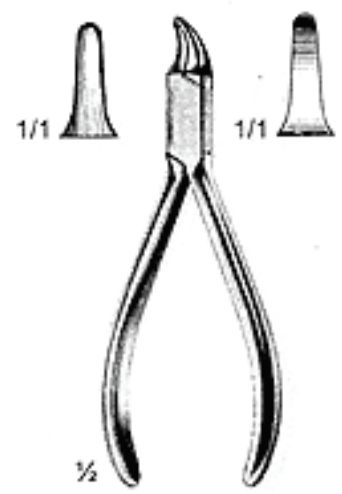

115
 31-040-13
 13 cm
 Reynolds

ORTHODONTICS PLIERS
 ORTHODONTIE ZANGEN
 ELICATES DE ORTODONCIA



139
 31-041-16
 16 cm



134
 31-042-16
 16 cm

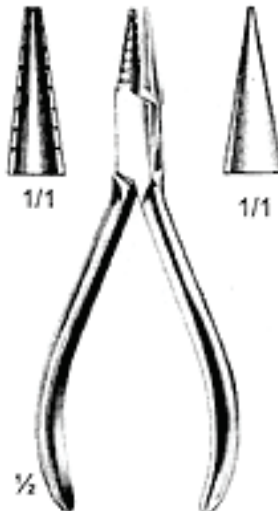

31-043-14
 14 cm
 Schwarz



31-044-11
 11.5 cm



200
 31-045-13
 13 cm



100
 31-046-14
 14 cm



31-047-21
 21 cm
 Malottky

Mc Kellops

Aderer

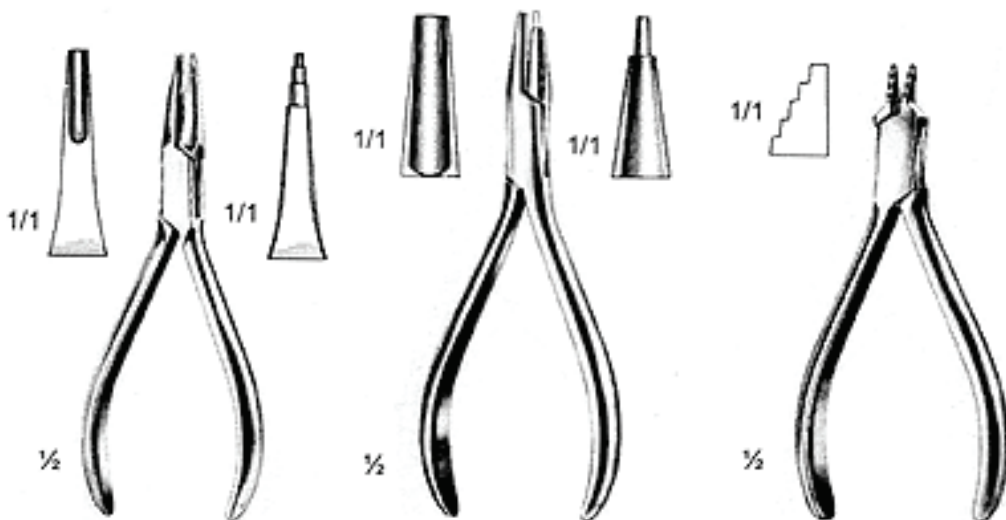

31-048013
 13.5 cm
 Tweed

31-049-14
 14 cm
 Andresen

31-050-13
 13 cm
 Nance

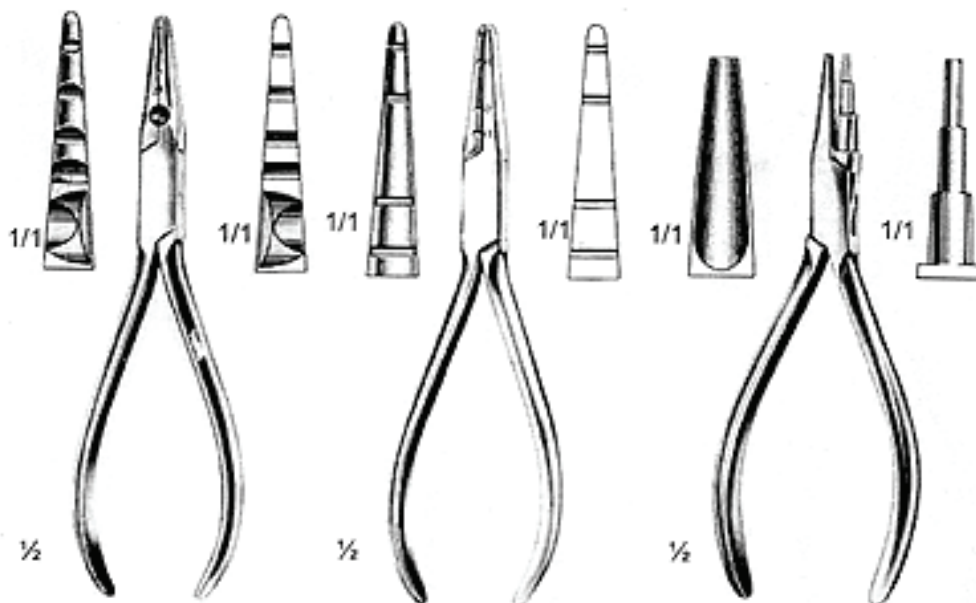

31-051-16
 16 cm

31-052-16
 16 cm
 Jelenko

31-053-15
 15 cm

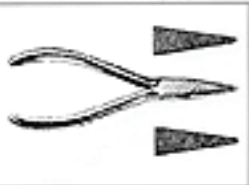

31-060-16
 16 cm
 Baade



255
 31-061-14
 14 cm
 Furrer



31-062-14
 14 cm



31-063-13
 13.5 cm

How



31-064-12
 12 cm

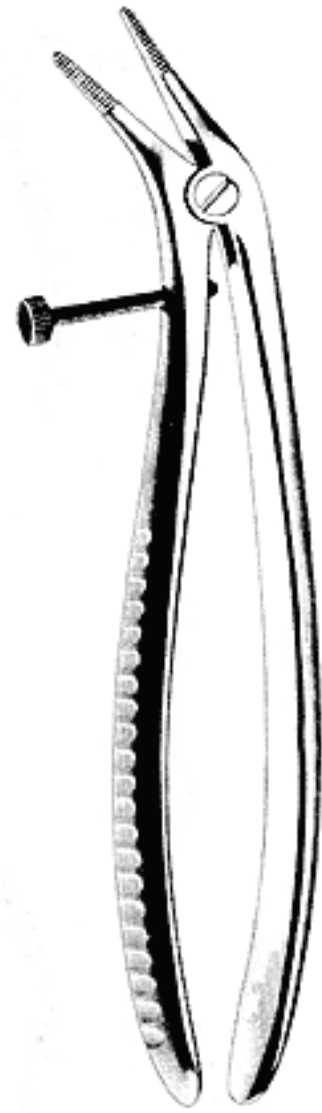

31-065-15
 15 cm
 Bohm

 $\frac{1}{2}$

31-066-14
14.5 cm
Triplex

 $\frac{1}{2}$

31-067-15
15 cm
Universal



31-068-14
14.5 cm



31-069-13
13 cm
Waldron

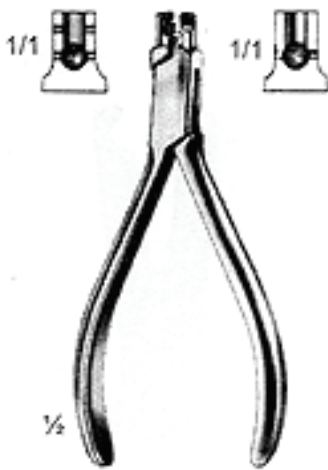

31-070-12
 12 cm
 Schwarz



31-071-13
 13 cm
 Schwarz

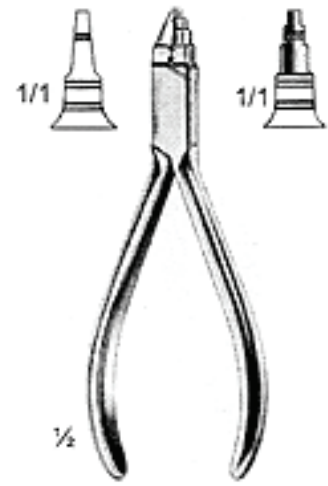

31-072-13
 13 cm
 Young

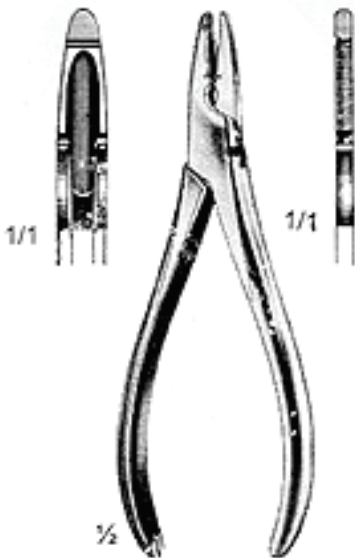

31-073-15
 15 cm
 Waldsachs

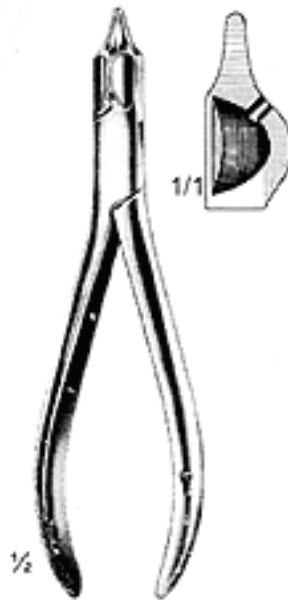

127
 31-074-16
 16 cm



31-075-16
 16 cm



Band Removing
with Plastic Pad
12 cm
31-093-14

No.141
14 cm
31-092-14

De La Rosa
14 cm
31-091-14

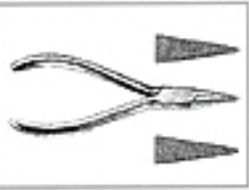

**TUNGSTEN
CARBIDE
INSERTS**



Ligature Cutter
11.7 cm
31-121-11



Distal Cutter
11.5 cm
31-122-11



Ligature Cutter
11.7 cm
31-123-11



Distal Cutter
11.5 cm
31-124-11

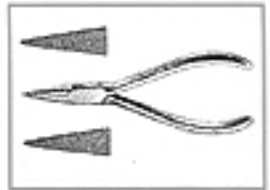

TUNGSTEN CARBIDE INSERTS

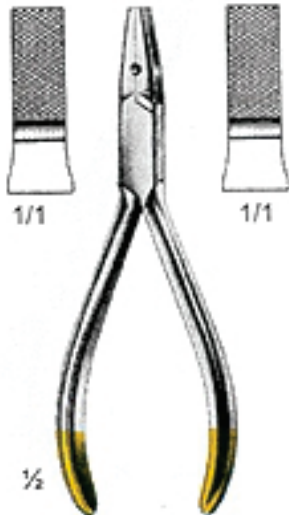

31-125-14
 14 cm

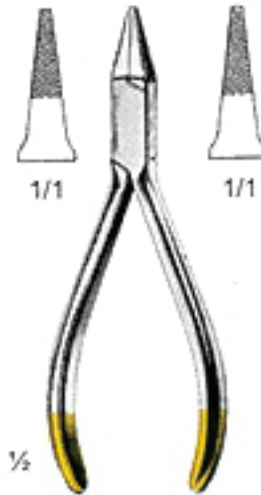

31-126-13
 13.5 cm

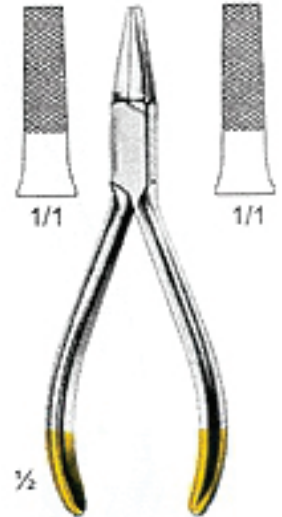

31-127-14
 14 cm

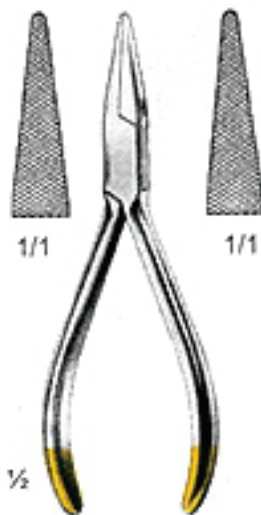

31-128-14
 14 cm

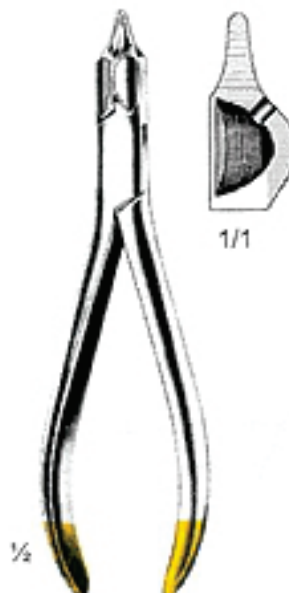

31-129-16
 16 cm
 Universal

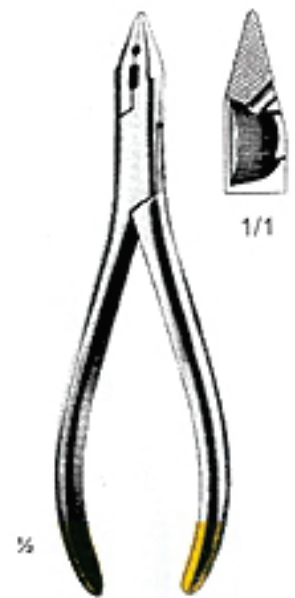

31-130-16
 16 cm
 Universal



1/5

31-131-12
 12.5 cm



31-132-13
 13 cm



31-133-13
 13 cm



31-134-16
 16 cm



31-135-00



31-136-17
 17.5 cm



**TUNGSTEN
 CARBIDE
 INSERT**



31-137-12
 12 cm



1/1



Weingart
 13 cm
 31-140-13

Department

32

SCISSORS
SCHEREN
TIJERAS

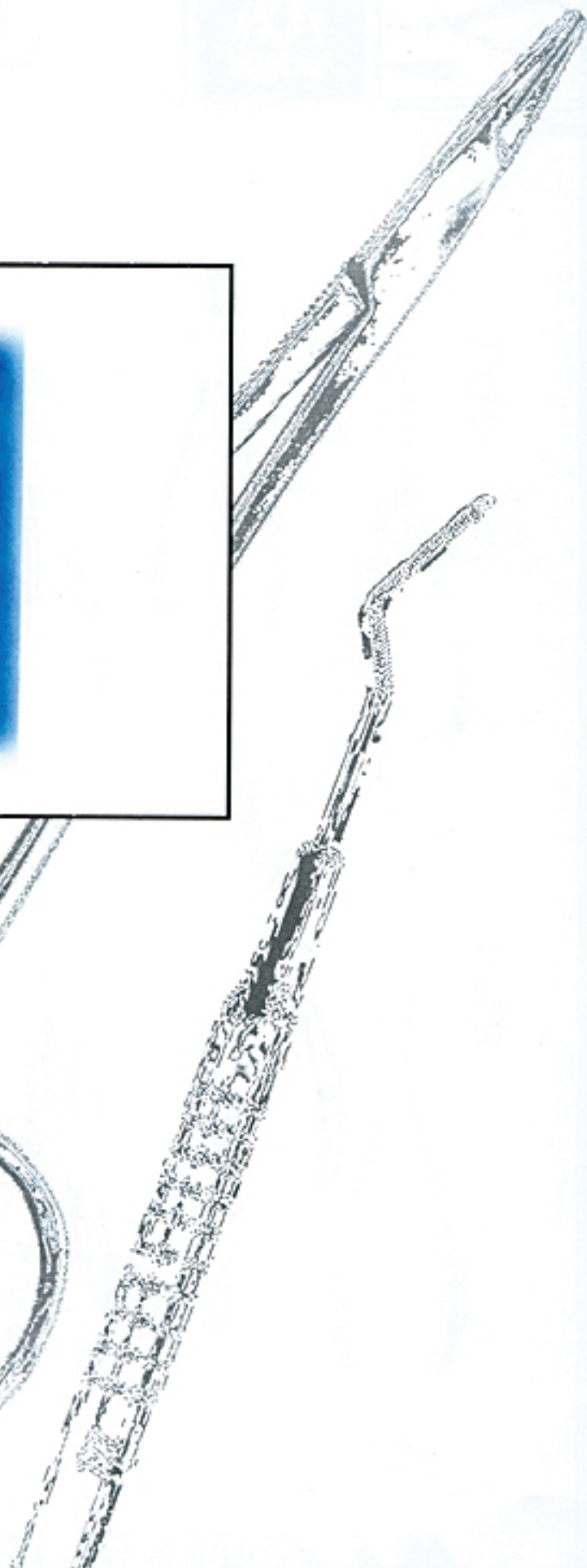
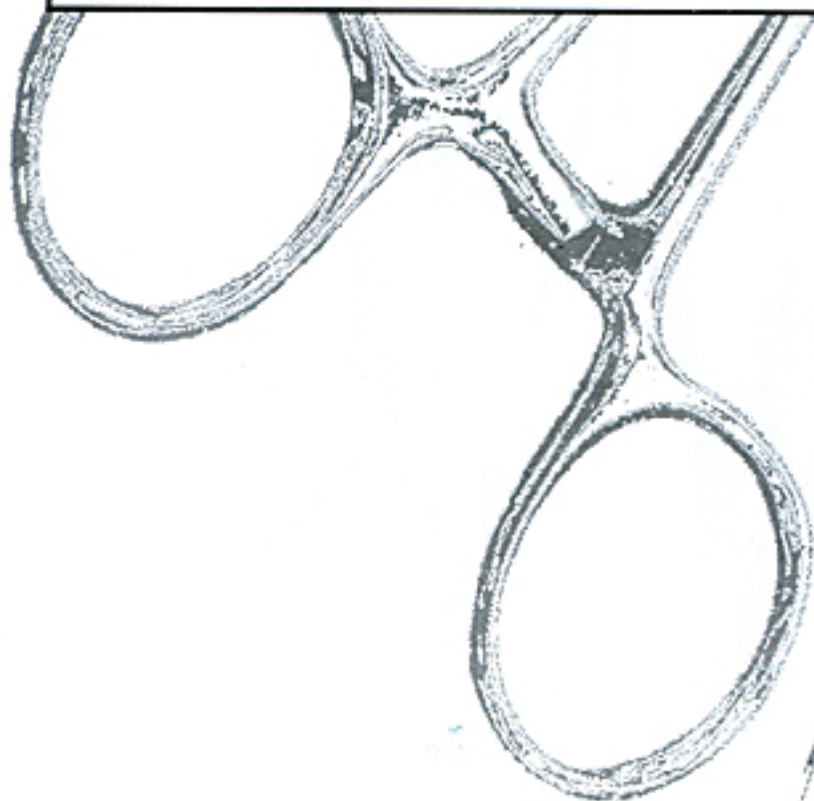

DEPARTMENT NO. 32

FROM
PAGE#

376

TO
PAGE#

382

INSTRUMENTS CATEGORY

SCISSORS
SCHEREN
TIJERAS

CUTICLE SCISSORS, NAIL FILES
 MAGELHAUTSCHEREN, NAGELFEILEN
 TIJERAS PARA UNAS, LIMES A ONGLES

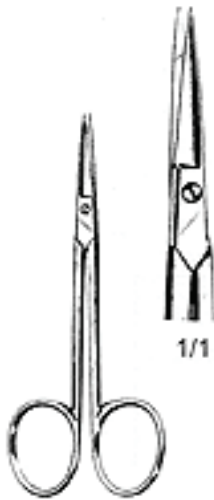

32-001-10
10 cm

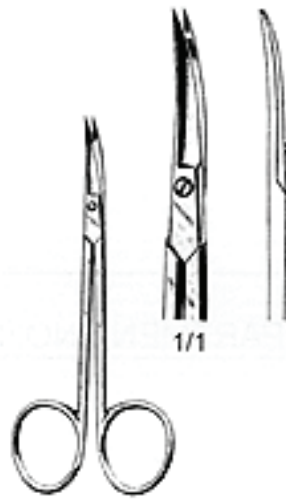

32-002-10
10.5 cm



32-003-10
10 cm



32-001-10
10 cm



32-005-12
12 cm



32-006-11
11 cm



32-007-10
10 cm



32-058-12
12 cm



32-059-11(11cm)
32-060-13(13cm)
32-061-15(15cm)

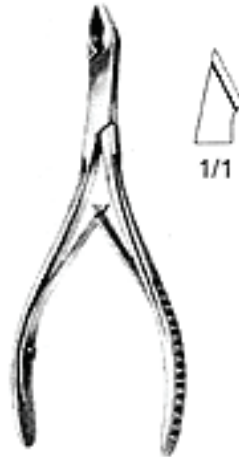

32-062-11(11cm)
32-063-13(13cm)

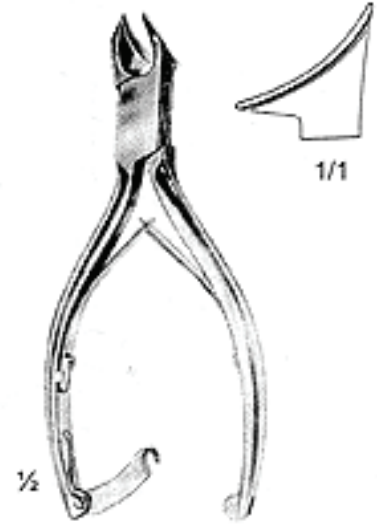

32-064-14
14 cm



32-065-14(14cm)
32-066-16(16cm)



32-067-11(11cm)
32-068-13(13cm)
Turnbull



32-069-13
13 cm

SCISSORS
SCHEREN
TIJERAS



32-120-18
18 cm



32-121-20(20 cm)
32-122-25(25 cm)

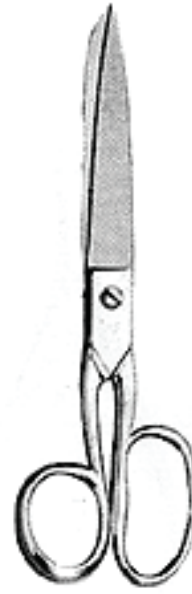

32-123-18
18 cm



32-124-13(13 cm)
32-125-16(16 cm)

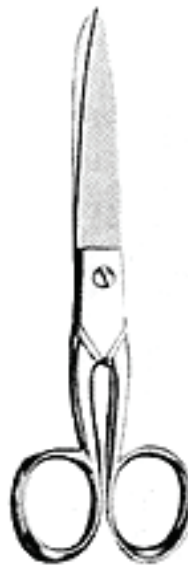

32-126-13
13 cm



32-127-11
11.5 cm

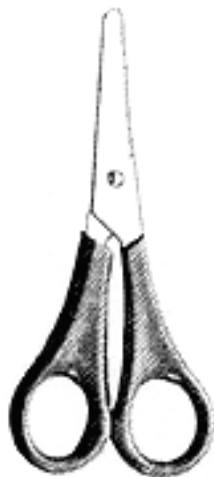

32-128-12
12 cm

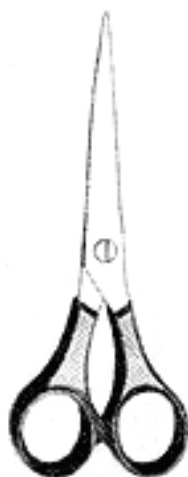

32-129-15
15 cm

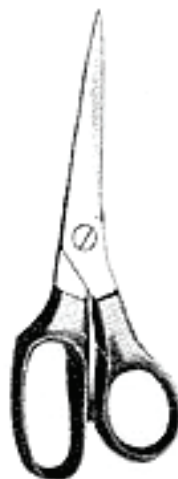

32-130-18
18 cm



32-131-14(14.5 cm)
32-132-18(18 cm)
Lister



32-133-00

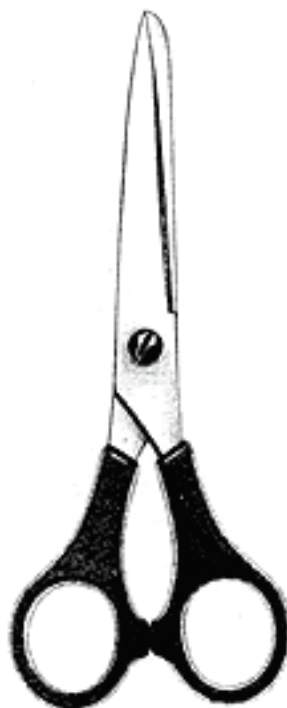

32-134-14
14 cm



32-135-18
18 cm
Universal



medisana
International

medisana International

P.O Box 1357

Sialkot - Pakistan

Tel: 0092 52 4264571

Fax: 0092 52 4264026

Email : info@medisanaintl.com