

VETERINARY INSTRUMENTS CATALOGUE



medisana
International



40-0106-20
20 cm
TAYLOR



40-0114-21
21 cm
DEJERINE



41-0134-03
No. 3



41-0138-04
No. 4



41-0186-18
#1
LANGENBECK



41-0190-18
#2
LANGENBECK



33-421-00
BEAVER

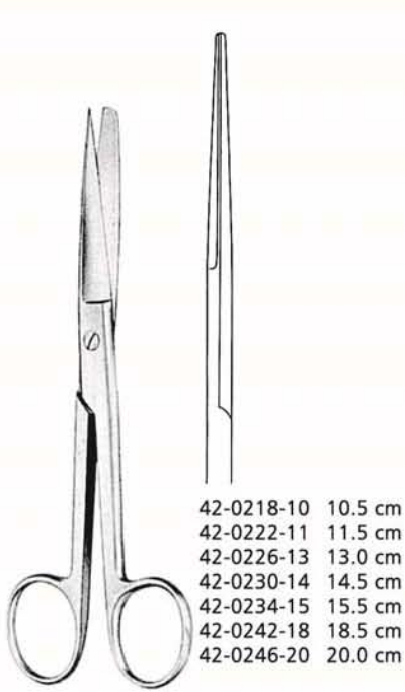

42-0218-10 - 42-0246-20

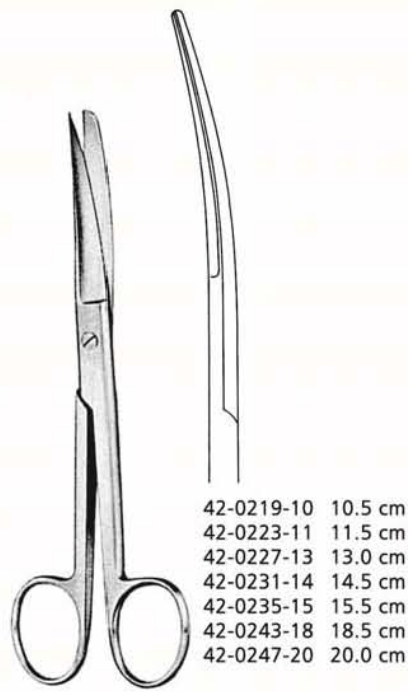

42-0219-10 - 42-0247-20

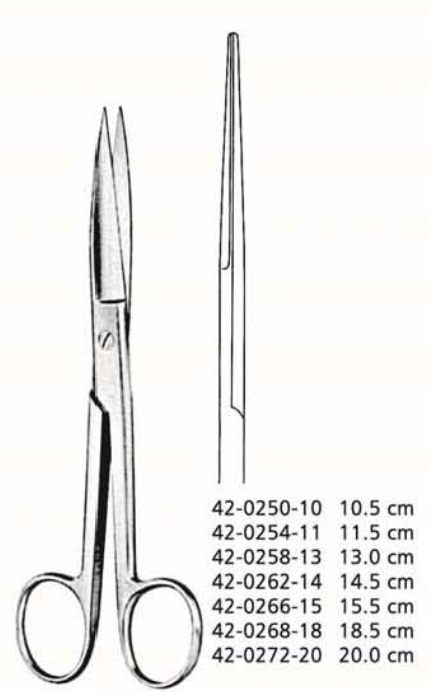

42-0250-10 - 42-0272-20

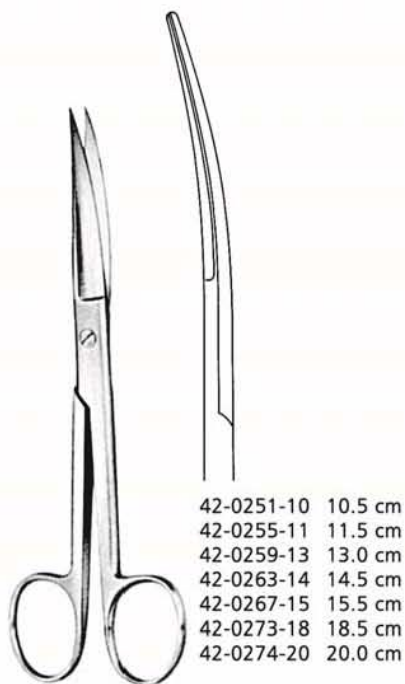

42-0251-10 - 42-0274-20

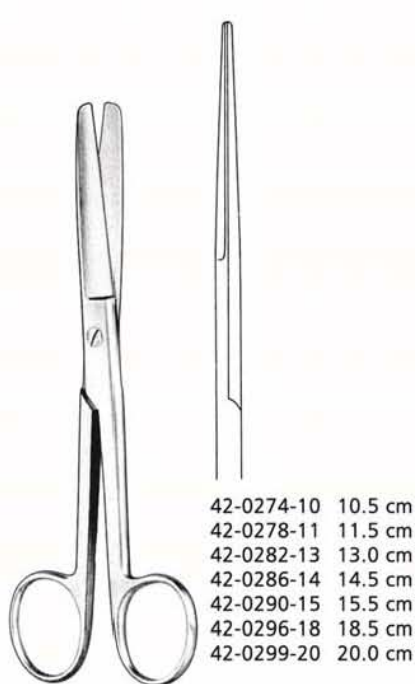

42-0274-10 - 42-0299-20

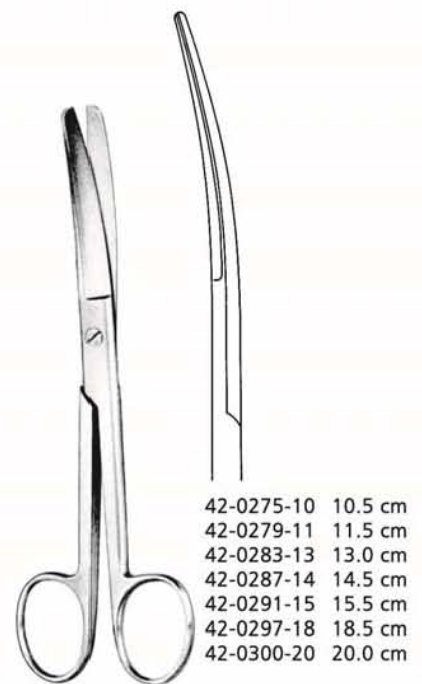

42-0275-10 - 42-0300-20



42-0314-14 14.0 cm
42-0318-15 15.0 cm
42-0322-17 17.0 cm
42-0326-23 23.0 cm

42-0314-14 - 42-0326-23
MAYO

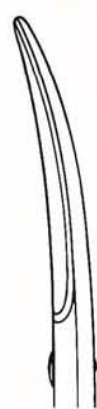

42-0315-14 14.0 cm
42-0319-15 15.0 cm
42-0323-17 17.0 cm
42-0327-23 23.0 cm

42-0315-14 - 42-0327-23
MAYO



42-0390-13 13.0 cm
42-0394-14 14.0 cm

42-0390-13 - 42-0394-14
INCISIONS

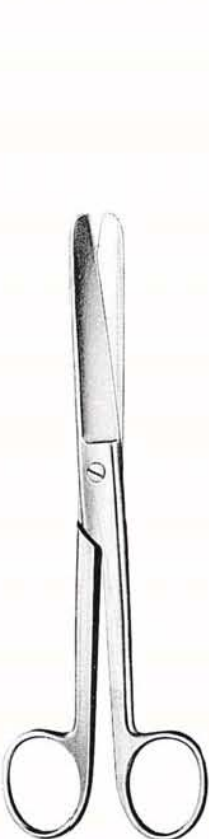

42-0202-17 42-0203-17

42-0202-17 - 42-0203-17
17 cm
DOYEN

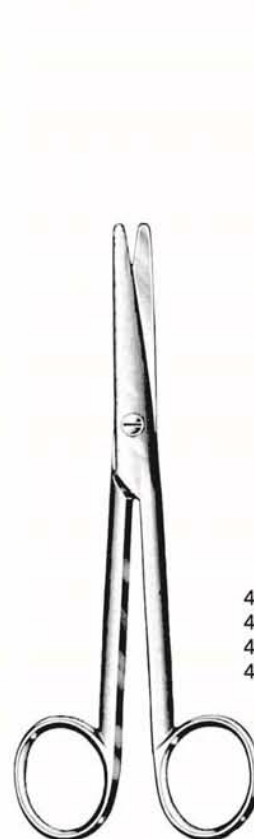

42-0316-14 14.0 cm
42-0319-17 17.0 cm
42-0323-19 19.0 cm
42-0327-21 21.0 cm
42-0317-14 14.0 cm
42-0320-17 17.0 cm
42-0324-19 19.0 cm
42-0328-21 21.0 cm

42-0316-14 - 42-0328-21
MAYO-STILLE



- | | | | |
|------------|---------|------------|---------|
| 42-0580-14 | 14.0 cm | 42-0581-14 | 14.0 cm |
| 42-0582-18 | 18.0 cm | 42-0583-18 | 18.0 cm |
| 42-0586-20 | 20.0 cm | 42-0587-20 | 20.0 cm |
| 42-0590-23 | 23.0 cm | 42-0591-23 | 23.0 cm |
| 42-0594-25 | 25.0 cm | 42-0593-25 | 25.0 cm |
| 42-0598-28 | 28.0 cm | 42-0599-28 | 28.0 cm |
| 42-0602-30 | 30.0 cm | 42-0603-30 | 30.0 cm |

42-0580-14 - 42-0603-30
 METZENBAUM-NELSON

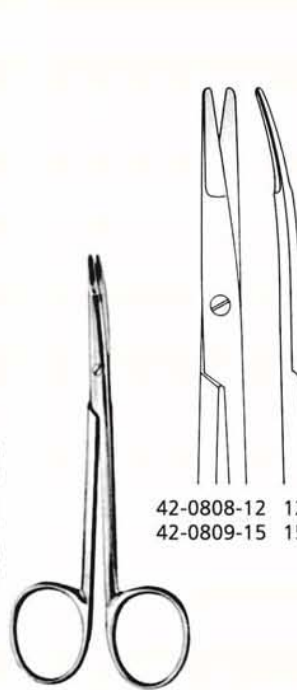

- | | |
|------------|---------|
| 42-0808-12 | 12.0 cm |
| 42-0809-15 | 15.0 cm |

42-0808-12 - 42-0809-15
 KILNER



- | | |
|------------|---------|
| 42-0810-13 | 13.0 cm |
| 42-0811-15 | 15.0 cm |

42-0810-13 - 42-0811-15
 RAGNELL (KILNER)



- | | |
|------------|------------|
| 42-0218-11 | 42-0219-11 |
|------------|------------|

42-0218-11 - 42-0219-11
 11.5 cm
 IRIS



- | | |
|------------|------------|
| 42-0532-10 | 42-0533-10 |
|------------|------------|

42-0532-10 - 42-0533-10
 10.5 cm (sharp-schard-agudo)
 STEVENS



16-0370-12
 12.0 cm
 UNIVERSAL



42-0916-09 9.0 cm
42-0920-10 10.5 cm
42-0924-13 13 cm
SPENCER



42-0944-14
14.0 cm
LITTAUER



42-0927-11
11.5 cm



46-0989-12
12.0 cm
MICHEL



46-0982-12
12.0 cm
MICHEL

DISSECTING SCISSORS WITH TUNDSTEN CARBIDE INSERTS
 PRAPARIERSCHEREN MIT HARTMETALLEINSATZEN
 TIJERAS PARA PREPARACIONES CON BOCAS DE CARBURO DE TUNGSTENO

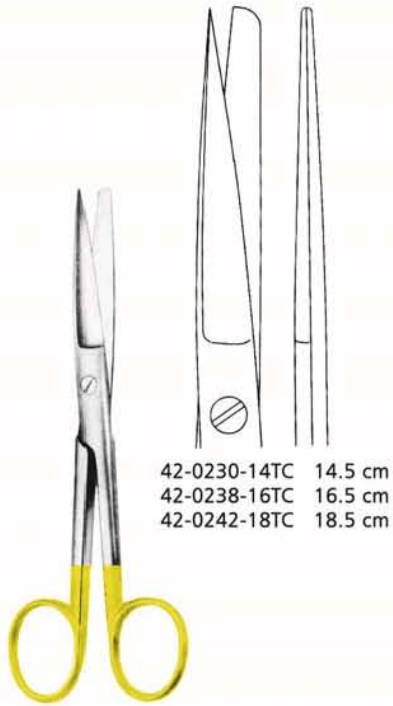

42-0230-14TC 14.5 cm
 42-0238-16TC 16.5 cm
 42-0242-18TC 18.5 cm

42-0230-14TC - 42-0242-18TC

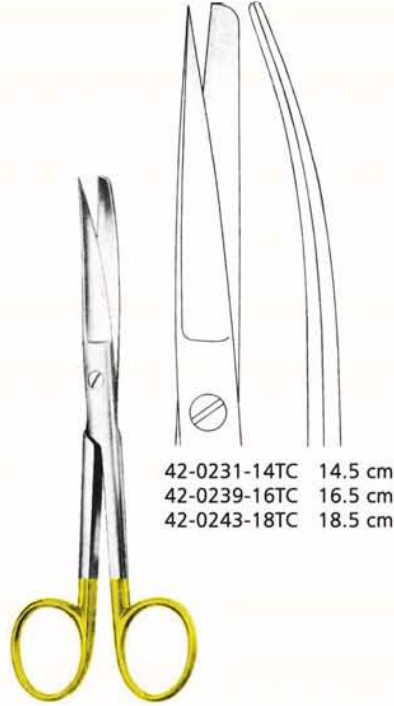

42-0231-14TC 14.5 cm
 42-0239-16TC 16.5 cm
 42-0243-18TC 18.5 cm

42-0231-14TC - 42-0243-18TC

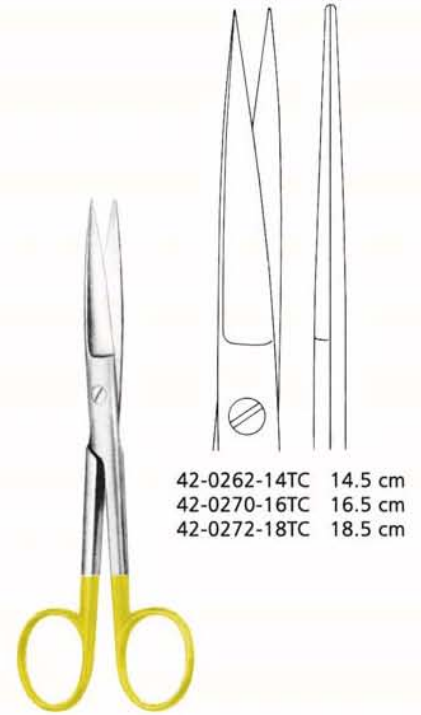

42-0262-14TC 14.5 cm
 42-0270-16TC 16.5 cm
 42-0272-18TC 18.5 cm

42-0262-14TC - 42-0272-18TC

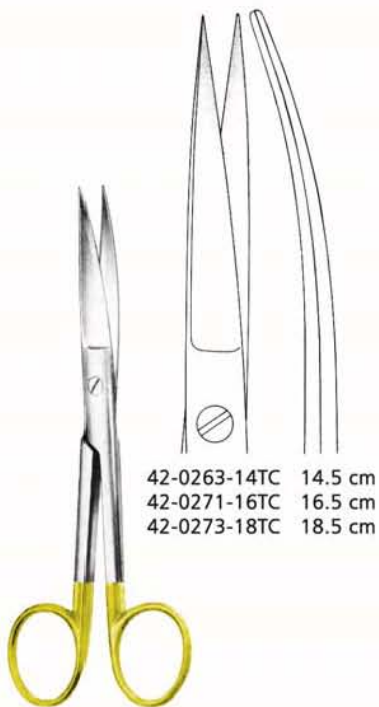

42-0263-14TC 14.5 cm
 42-0271-16TC 16.5 cm
 42-0273-18TC 18.5 cm

42-0263-14TC - 42-0273-18TC

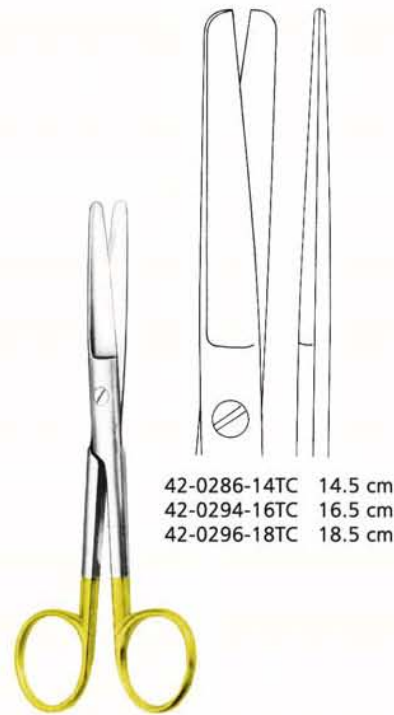

42-0286-14TC 14.5 cm
 42-0294-16TC 16.5 cm
 42-0296-18TC 18.5 cm

42-0286-14TC - 42-0296-18TC

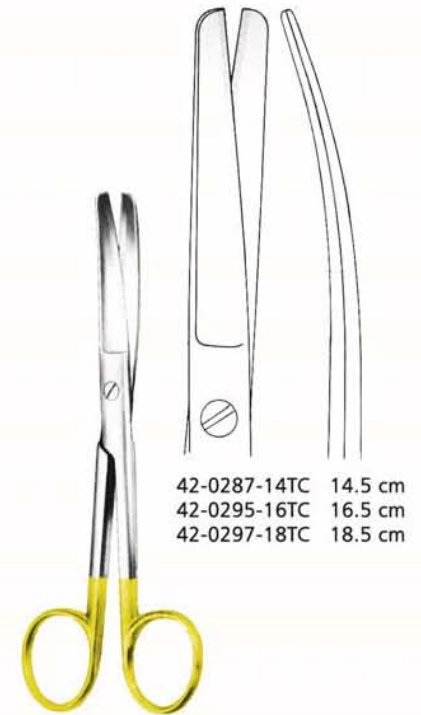

42-0287-14TC 14.5 cm
 42-0295-16TC 16.5 cm
 42-0297-18TC 18.5 cm

42-0287-14TC - 42-0297-18TC



42-1046-14 14.0 cm
 42-1048-18 18.0 cm
 42-1052-20 20.0 cm

42-1046-14 - 42-1052-20
 METZENBAUM



42-1047-14 14.0 cm
 42-1049-18 18.0 cm
 42-1053-20 20.0 cm

42-1047-14 - 42-1053-20
 METZENBAUM

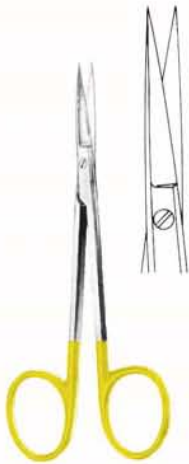

42-1208-11
 11.5 cm
 IRIS

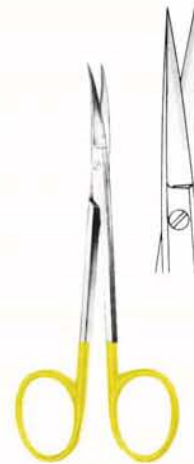

42-1209-11
 11.5 cm
 IRIS

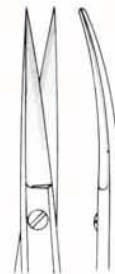



42-0379-14 14 cm
 42-0383-18 18 cm
 42-0387-20 20 cm
 LISTER



58-0125-24 24 cm
 BRUNS

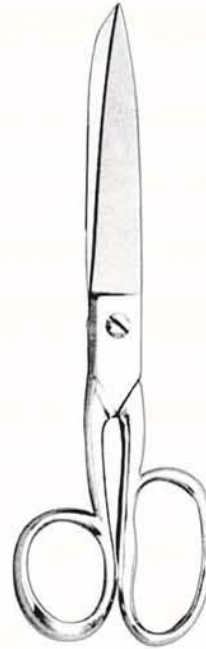

42-0960-18 18 cm
 42-0960-20 20 cm
 SMITH

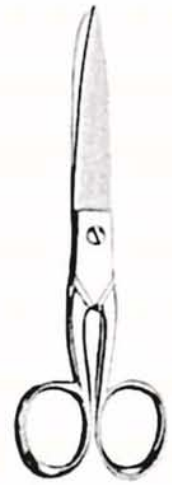

42-0972-13 13 cm
 42-0972-16 16 cm
 42-0972-18 18 cm
 42-0972-20 20 cm



42-0379-23 23 cm
 BERGMANN

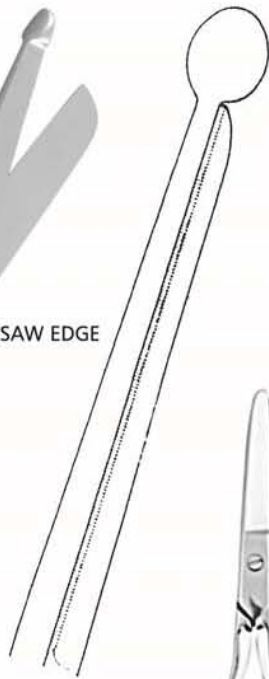

42-0976-11 11 cm
 POCKET



42-0980-12 12 cm
 POCKET

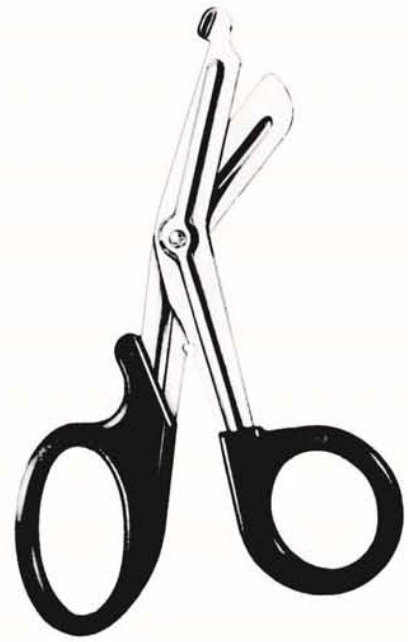

58-0133-15 15 cm
 58-0137-18 18 cm
 LISTER (UNIVERSAL)
 (HANDLE AVAILABLE IN DIFFERENT COLOURS)



44-0332-11 11.5 cm
 44-0336-13 13.0 cm
 44-0340-14 14.5 cm
 44-0344-16 16.0 cm
 44-0348-18 18.0 cm
 44-0352-20 20.0 cm
 44-0356-25 25.0 cm
 44-0360-30 30.0 cm

44-0332-11 - 44-0360-30



44-0368-11 11.5 cm
 44-0372-13 13.0 cm
 44-0376-14 14.5 cm
 44-0380-16 16.0 cm
 44-0384-18 18.0 cm
 44-0388-20 20.0 cm
 44-0392-25 25.0 cm

44-0368-11 - 44-0392-25
 narrow-schmal-estrecmas



44-0916-18 18.0 cm
 44-0920-21 21.0 cm
 44-0924-25 25.0 cm

44-0916-18 - 44-0924-25
 POTTS-SMITH



44-0858-15 44-0860-15

44-0858-15 - 44-0860-15
 15.0 cm
 McINDOE



44-0130-12 12.0 cm
 44-0134-15 15.0 cm

44-0130-12 - 44-0134-15
 MICRO ADSON



44-0146-12 12.0 cm
 44-0150-15 15.0 cm

44-0146-12 - 44-0150-15
 ADSON



JAW ATRAUMA
 MAUL ATRAUMA
 BOCAS ATRAUMA

1.5 mm

55-0328-16 16.0 cm
 55-0332-20 20.0 cm
 55-0336-24 24.0 cm

55-0328-16 - 55-0336-24
 DE BAKKEY



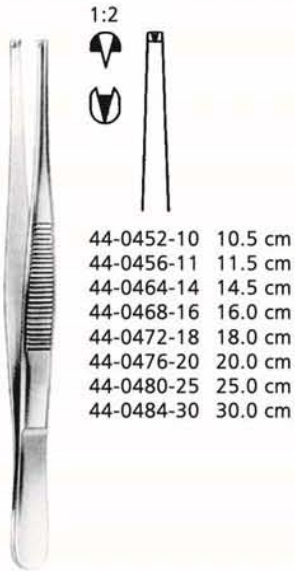

- 44-0452-10 10.5 cm
- 44-0456-11 11.5 cm
- 44-0464-14 14.5 cm
- 44-0468-16 16.0 cm
- 44-0472-18 18.0 cm
- 44-0476-20 20.0 cm
- 44-0480-25 25.0 cm
- 44-0484-30 30.0 cm

44-0452-10 - 44-0484-30

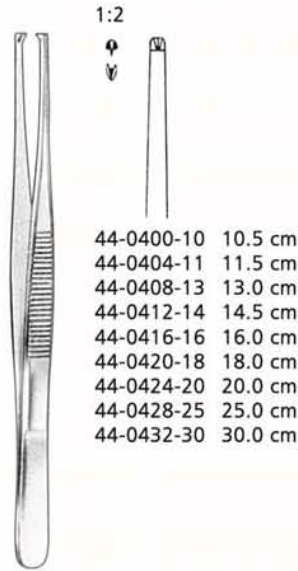

- 44-0400-10 10.5 cm
- 44-0404-11 11.5 cm
- 44-0408-13 13.0 cm
- 44-0412-14 14.5 cm
- 44-0416-16 16.0 cm
- 44-0420-18 18.0 cm
- 44-0424-20 20.0 cm
- 44-0428-25 25.0 cm
- 44-0432-30 30.0 cm

44-0400-10 - 44-0432-30
 narrow-schmal-estrecmas

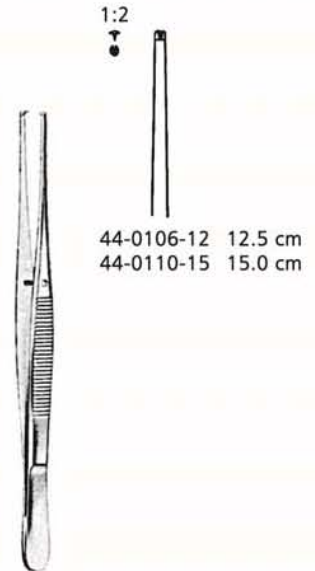

- 44-0106-12 12.5 cm
- 44-0110-15 15.0 cm

44-0106-12 - 44-0110-15
 SEMKEN

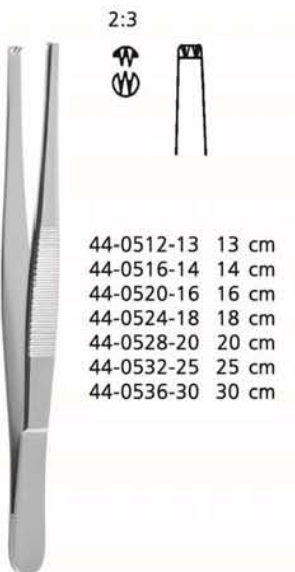

- 44-0512-13 13 cm
- 44-0516-14 14 cm
- 44-0520-16 16 cm
- 44-0524-18 18 cm
- 44-0528-20 20 cm
- 44-0532-25 25 cm
- 44-0536-30 30 cm

44-0512-13 - 44-0536-30

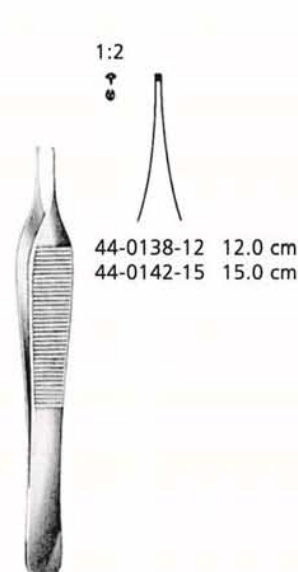

- 44-0138-12 12.0 cm
- 44-0142-15 15.0 cm

44-0138-12 - 44-0142-15
 MICRO ADSON

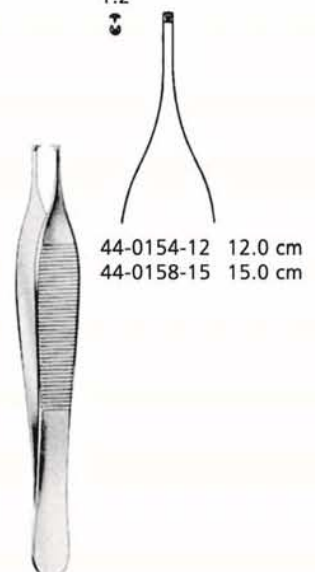

- 44-0154-12 12.0 cm
- 44-0158-15 15.0 cm

44-0154-12 - 44-0158-15
 ADSON



44-0598-07 7.5 cm
44-0602-09 9.0 cm
44-0606-11 11.0 cm

44-0598-07 - 44-0606-11
FEILCHENFELD

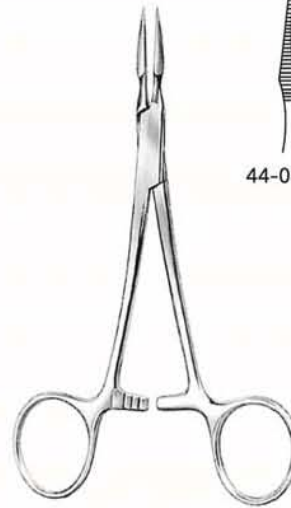

44-0834-13 44-0837-13

44-0834-13 - 44-0837-13
13.0 cm
STIEGLITZ



44-0764-08 8.0 cm
44-0768-09 9.0 cm
44-0772-10 10.5 cm
44-0776-11 11.5 cm
44-0780-12 12.5 cm
44-0784-14 14.5 cm

44-0764-08 - 44-0784-14



44-0789-08 8.0 cm
44-0793-09 9.0 cm
44-0797-10 10.5 cm
44-0801-11 11.5 cm
44-0805-12 12.5 cm
44-0809-14 14.5 cm

44-0789-08 - 44-0809-14



44-0815-15
15.0 cm

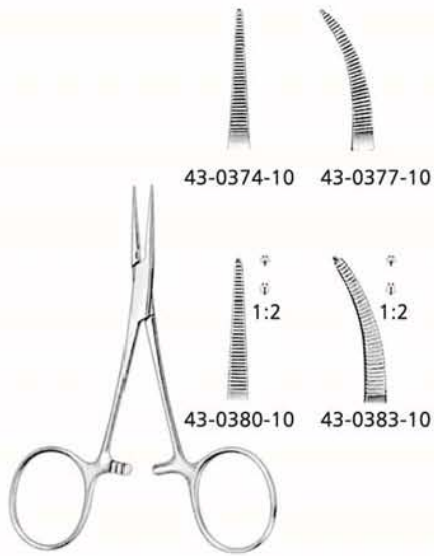

43-0374-10 43-0377-10

43-0380-10 43-0383-10

43-0374-10 - 43-0383-10
 10.0 cm
 BABY MOSQUITO

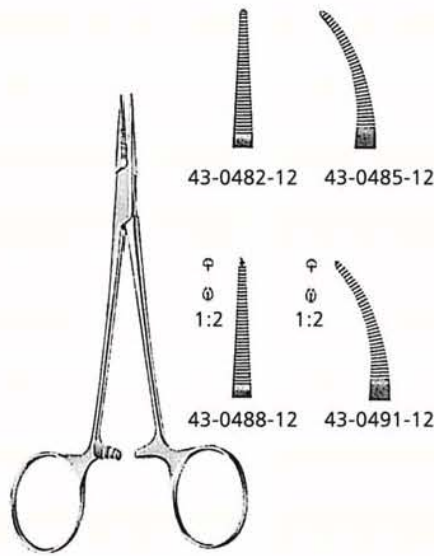

43-0482-12 43-0485-12

43-0488-12 43-0491-12

43-0482-12 - 43-0491-12
 12.5 cm
 MICRO-HALSTED

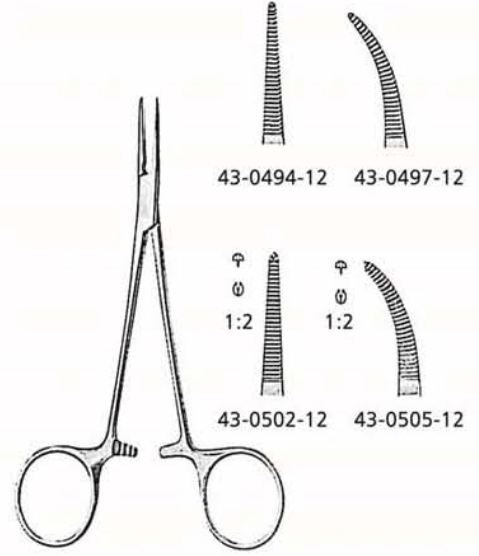

43-0494-12 43-0497-12

43-0502-12 43-0505-12

43-0494-12 - 43-0505-12
 12.5 cm
 HALSTED-MOSQUITO

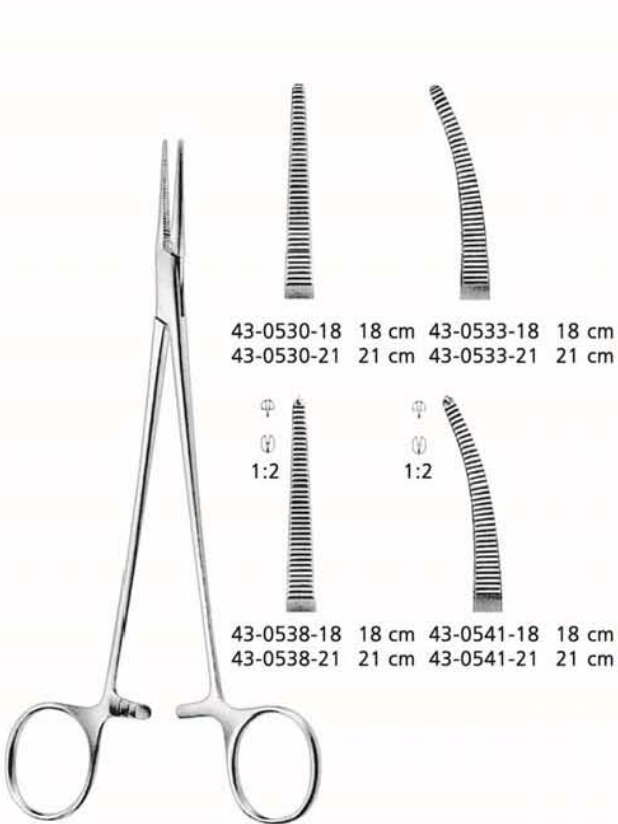

43-0530-18 18 cm 43-0533-18 18 cm
 43-0530-21 21 cm 43-0533-21 21 cm

1:2 1:2

43-0538-18 18 cm 43-0541-18 18 cm
 43-0538-21 21 cm 43-0541-21 21 cm

43-0530-18 - 43-0541-21
 HALSTED-MOSQUITO

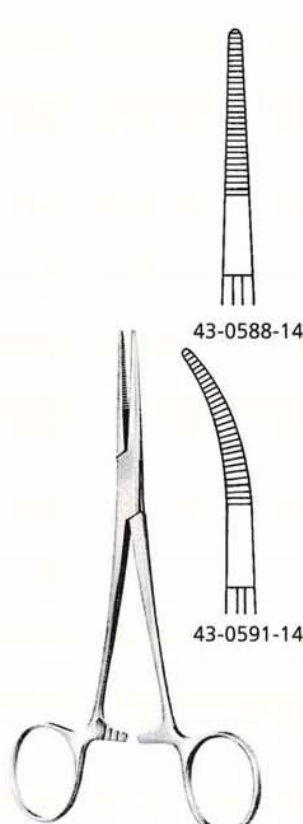

43-0588-14

43-0591-14

43-0588-14 - 43-0591-14
 14.0 cm
 KELLY

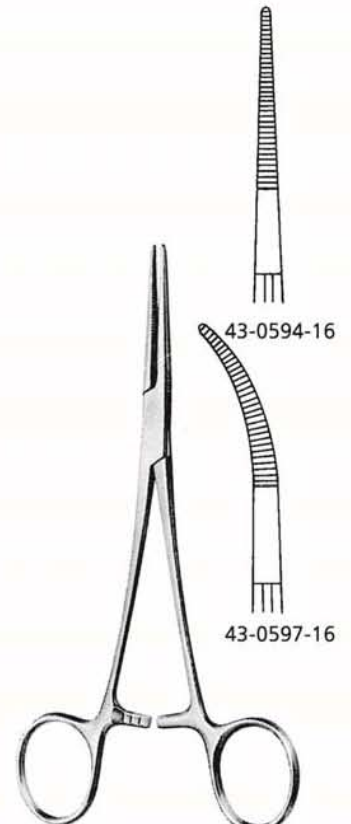

43-0594-16

43-0597-16

43-0594-16 - 43-0597-16
 16.0 cm
 KELLY-RANKIN

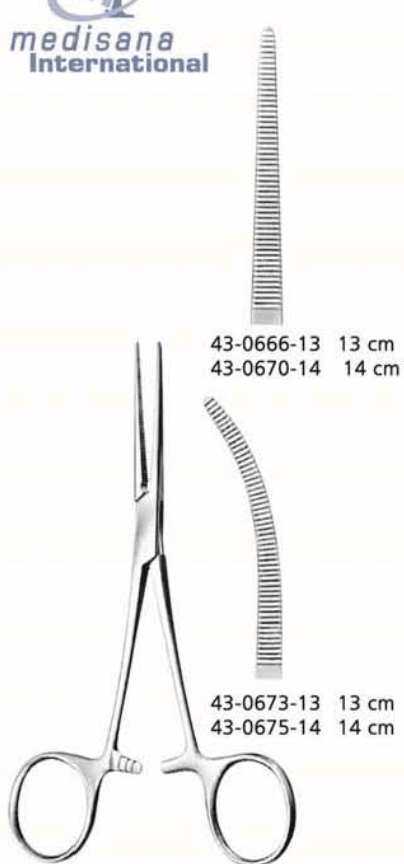

43-0666-13 13 cm
43-0670-14 14 cm

43-0673-13 13 cm
43-0675-14 14 cm

43-0666-13 - 43-0675-14
PEAN-DELICATE

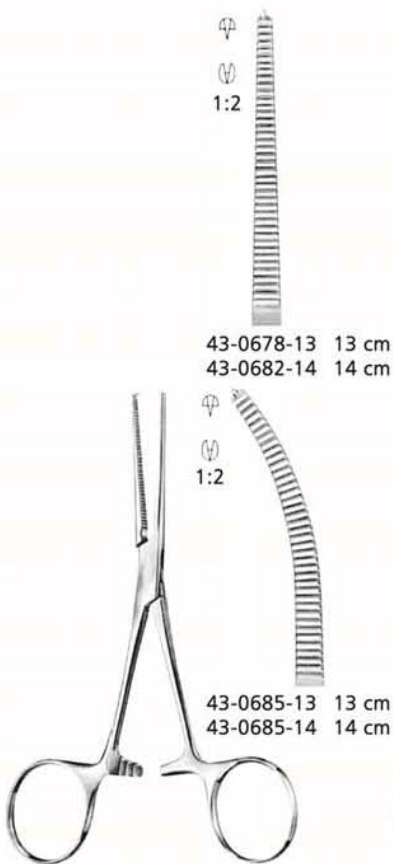

43-0678-13 13 cm
43-0682-14 14 cm

43-0685-13 13 cm
43-0685-14 14 cm

43-0678-13 - 43-0685-14
KOCHER-DELICATE

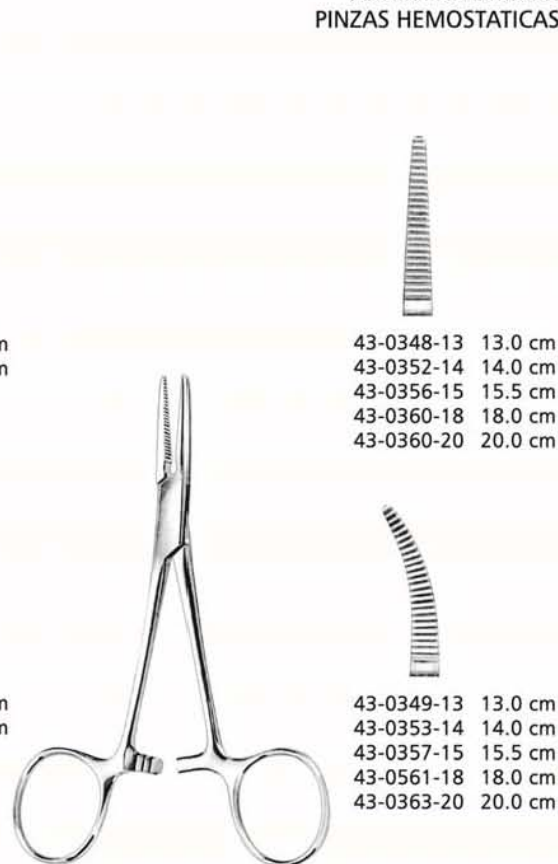

43-0348-13 13.0 cm
43-0352-14 14.0 cm
43-0356-15 15.5 cm
43-0360-18 18.0 cm
43-0360-20 20.0 cm

43-0349-13 13.0 cm
43-0353-14 14.0 cm
43-0357-15 15.5 cm
43-0561-18 18.0 cm
43-0363-20 20.0 cm

43-0348-13 - 43-0363-20
SPENCER-WELLS

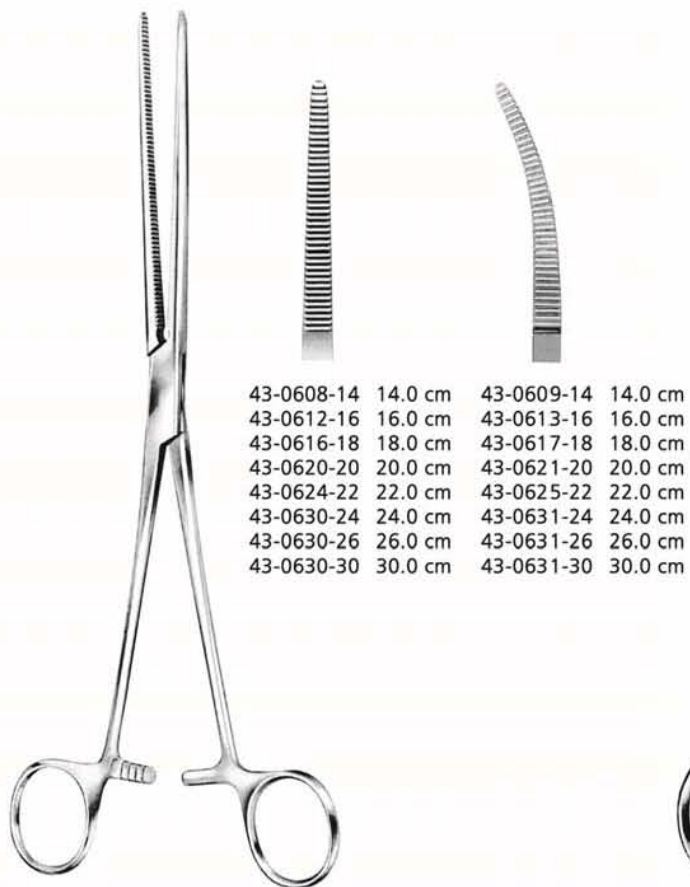

43-0608-14 14.0 cm	43-0609-14 14.0 cm
43-0612-16 16.0 cm	43-0613-16 16.0 cm
43-0616-18 18.0 cm	43-0617-18 18.0 cm
43-0620-20 20.0 cm	43-0621-20 20.0 cm
43-0624-22 22.0 cm	43-0625-22 22.0 cm
43-0630-24 24.0 cm	43-0631-24 24.0 cm
43-0630-26 26.0 cm	43-0631-26 26.0 cm
43-0630-30 30.0 cm	43-0631-30 30.0 cm

43-0608-14 - 43-0631-30
PEAN

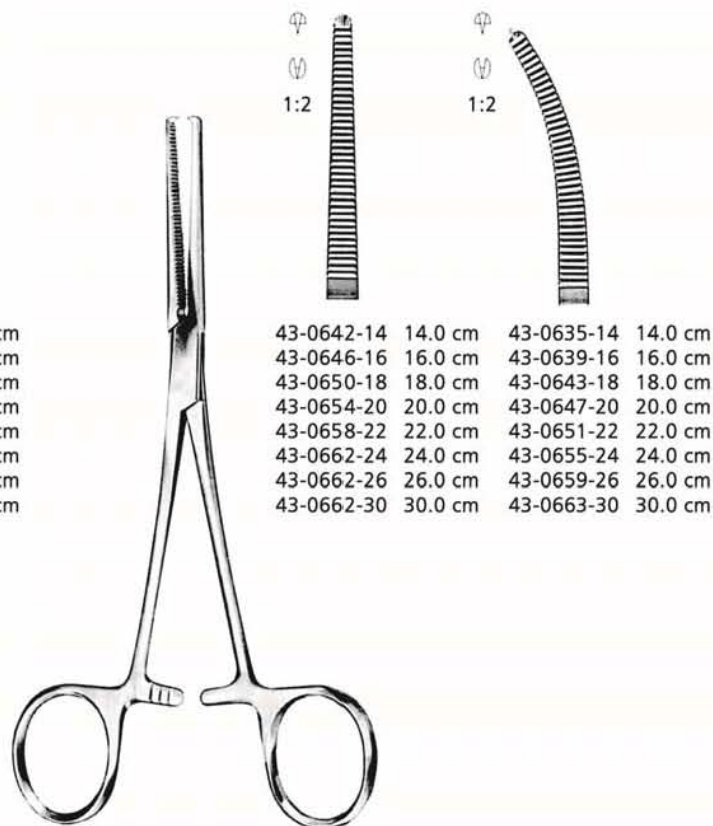

43-0642-14 14.0 cm	43-0635-14 14.0 cm
43-0646-16 16.0 cm	43-0639-16 16.0 cm
43-0650-18 18.0 cm	43-0643-18 18.0 cm
43-0654-20 20.0 cm	43-0647-20 20.0 cm
43-0658-22 22.0 cm	43-0651-22 22.0 cm
43-0662-24 24.0 cm	43-0655-24 24.0 cm
43-0662-26 26.0 cm	43-0659-26 26.0 cm
43-0662-30 30.0 cm	43-0663-30 30.0 cm

43-0642-14 - 43-0663-30
KOCHER-OCHSNER

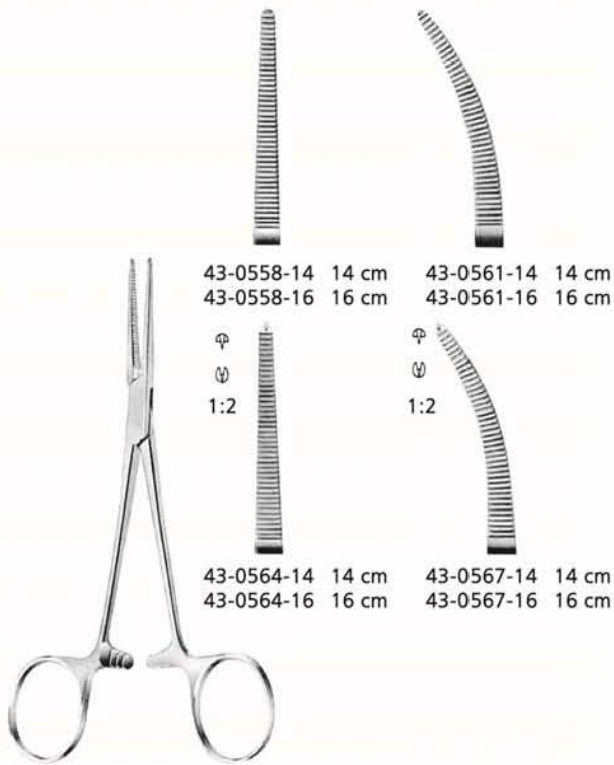

43-0558-14 - 43-0567-16
 CRILE

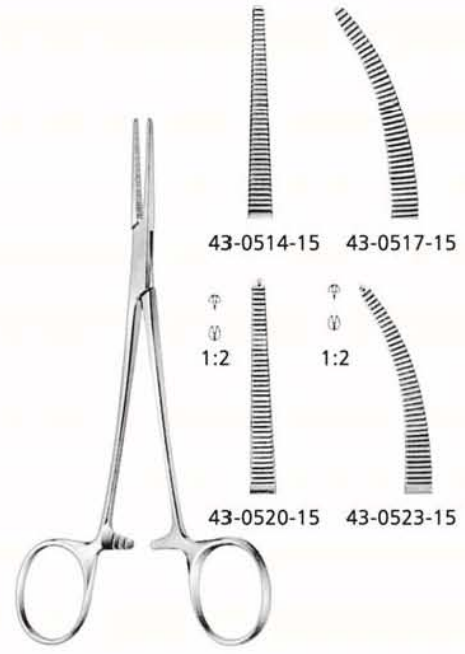

43-0514-15 - 43-0523-15
 15.0 cm
 LERICHE



43-0852-14
 14.5 cm
 KLINIKUM BERLIN

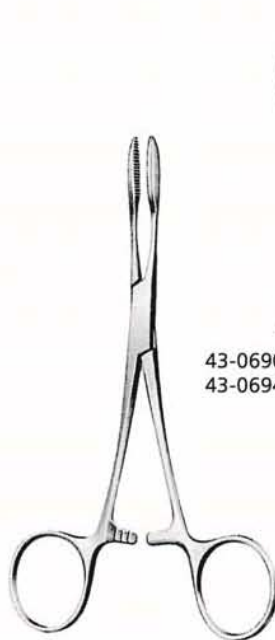

43-0690-14 - 43-0694-16
 PEAN

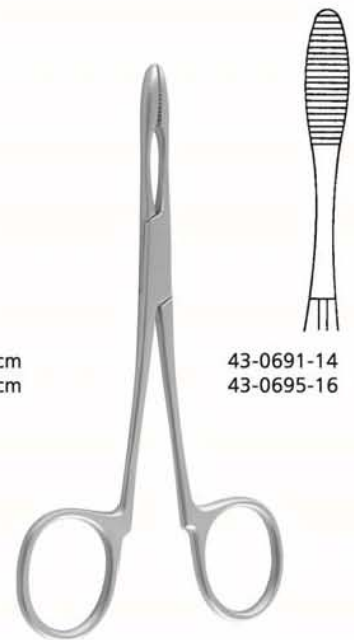

43-0691-14 - 43-0695-16
 PEAN



43-0909-05 5.0 cm
43-0913-09 9.0 cm
JONES



43-0921-09
9.0 cm
SCHAEDEL

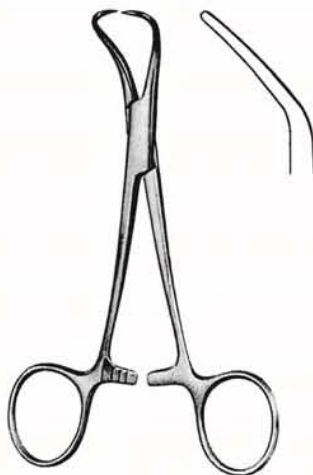

43-0865-08 8.0 cm
43-0869-11 11.0 cm
43-0873-13 13.0 cm
43-0873-15 15.0 cm
BACKHAUS

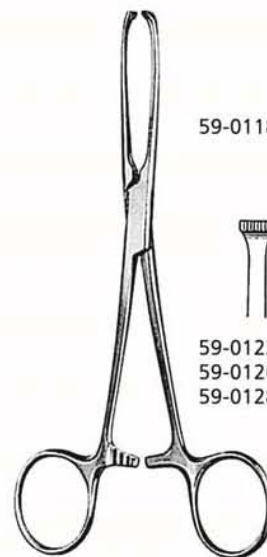

59-0118-15 - 59-0128-25
ALLIS

4:5

59-0118-15 15.0 cm

5:6

59-0122-15 15.0 cm
59-0126-19 19.0 cm
59-0128-25 25.0 cm

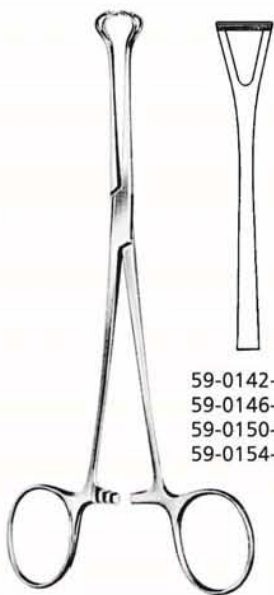

59-0142-16 - 59-0154-24
BABCOCK

59-0142-16 16.0 cm
59-0146-18 18.0 cm
59-0150-20 20.0 cm
59-0154-24 24.0 cm



59-0155-13 - 59-0157-13
BABY - KOCHER (very elastic blades)
13 cm

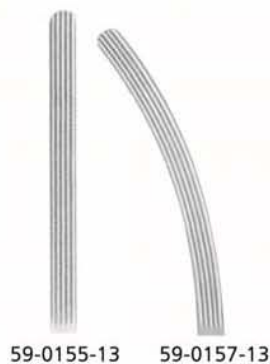

59-0155-13 59-0157-13



59-0160-24 - 59-0162-24
DOYEN (very elastic blades)
24 cm

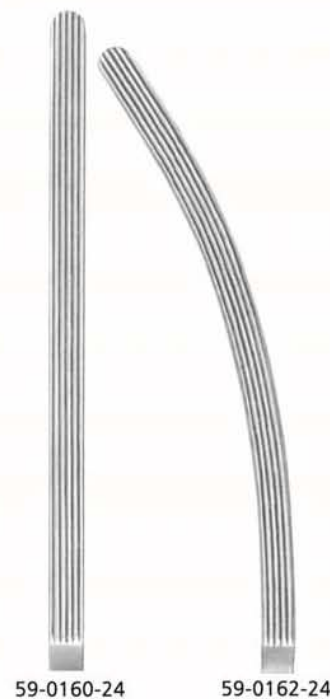

59-0160-24 59-0162-24



48-0272-16
sharp
scharf
agudo



48-0273-16
blunt
stumpf
romo

48-0272-16 - 48-0273-16
16.0 cm
SENN-MILLER



48-0652-15
10 X 6 mm

48-0656-15
20 X 6 mm

48-0652-15 - 48-0656-15
15.0 cm
SENN-GREEN



8 X 7 mm



18 X 5.5 mm

48-0652-16
16.5 cm
SENN-MILLER

OBSTETRICAL
GEBURTSHILFE
OBSTETRCAIA

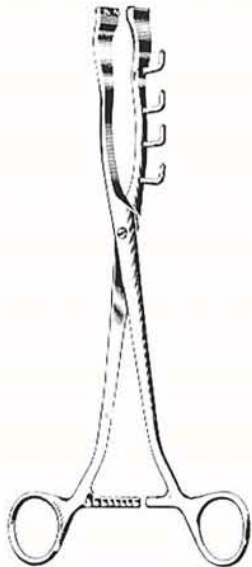

43-0852-24
24.0 cm
WEINGART MOD.

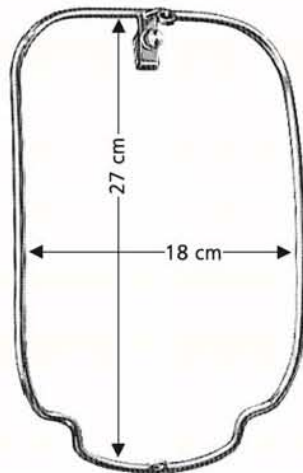

43-0852-00
WEINGART



43-0852-08
8.0 cm
WEINGART MOD.

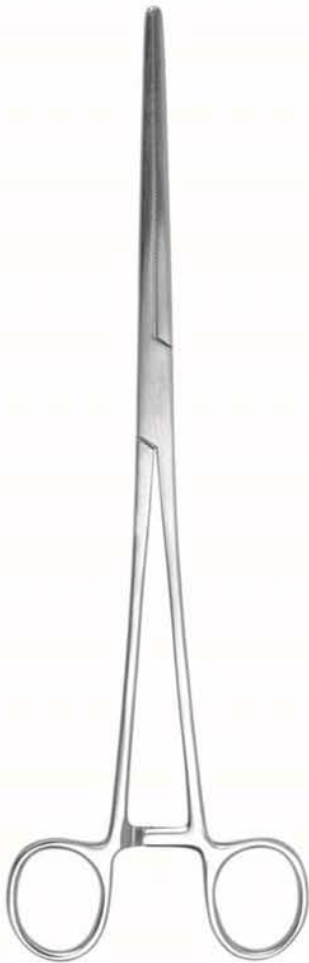

59-1162-25
25.0 cm
NITROGEN CONTAINER FORCEPS



59-1164-70
70.0 cm
NITROGEN CONTAINER FORCEPS



48-1244-10 10.5 cm
 sharp-scharf-agudo
 WEITLANER

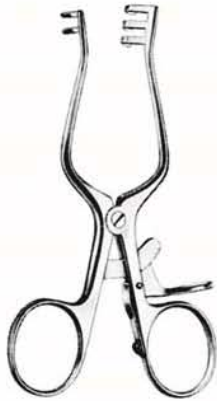

48-1253-10 10.5 cm
 blunt-stumpf-romo
 WEITLANER

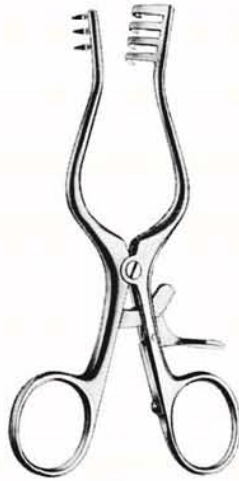

48-1248-13 13.0 cm
 48-1248-16 16.5 cm
 48-1248-20 20.0 cm
 48-1248-25 25.0 cm
 sharp-scharf-agudo
 WEITLANER

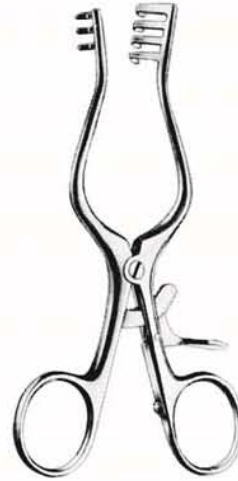

48-1257-13 13.0 cm
 48-1257-16 16.5 cm
 48-1257-20 20.0 cm
 48-1257-25 25.0 cm
 blunt-stumpf-romo
 WEITLANER

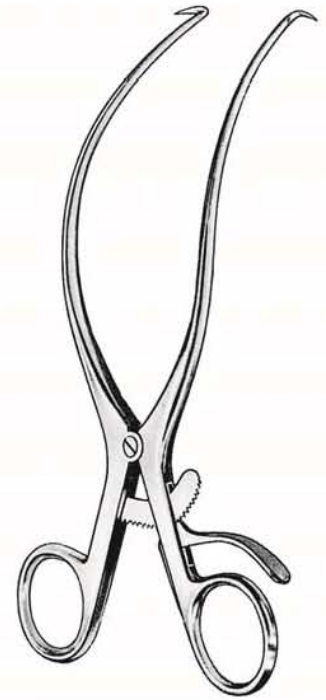

48-1364-09 9.0 cm
 48-1368-11 11.0 cm
 48-1372-14 14.0 cm
 48-1376-19 19.0 cm
 GELPLI



48-0292-05 5.0 cm sharp-scharf-agudo
 48-0293-05 5.0 cm blunt-stumpf-romo
 48-0296-07 7.0 cm sharp-scharf-agudo
 48-0297-07 7.0 cm blunt-stumpf-romo
 FINSEN



48-1264-10 10.0 cm sharp-scharf-agudo
 48-1265-10 10.0 cm blunt-stumpf-romo
 JANSEN

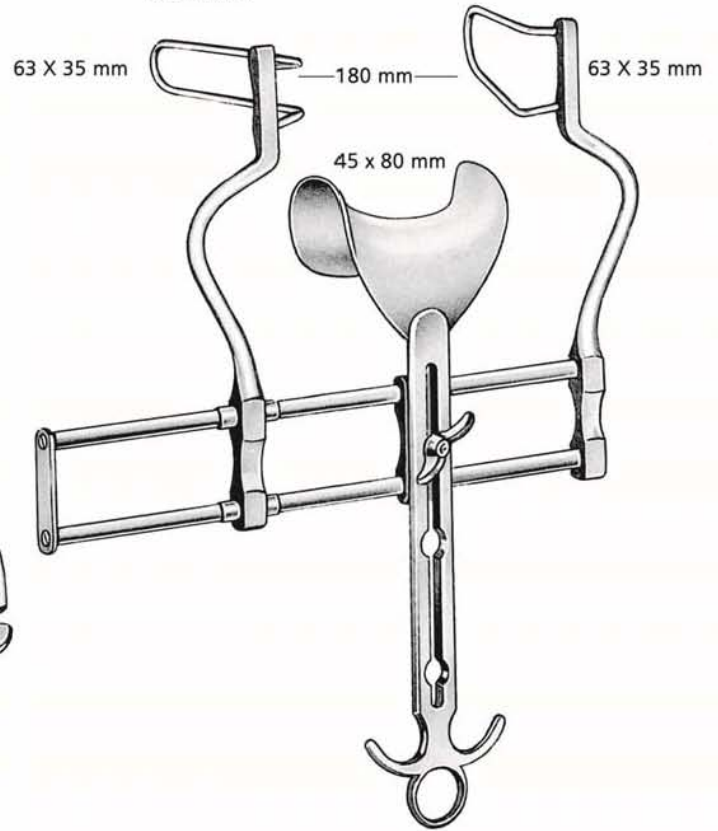

48-1504-18
 18.0 cm
 BALFOUR



MACINTOSH - ENGLISH PROFILE

PRODUCT CODE	Size	Description	Overall Length A (mm)	Distal Width B (mm)
57-001-01	1	Infant	92	14
57-001-02	2	Child	100	17
57-001-03	3	Medium Adult	130	18
57-001-04	4	Large Adult	155	18
57-001-05	5	X-Large Adult	175	24



MEDIUM



LARGE

PRODUCT CODE	Description	Overall Length (mm)	Batteries
57-701-02	Medium	160	2 "C"
57-701-03	Large	175	2 "D"

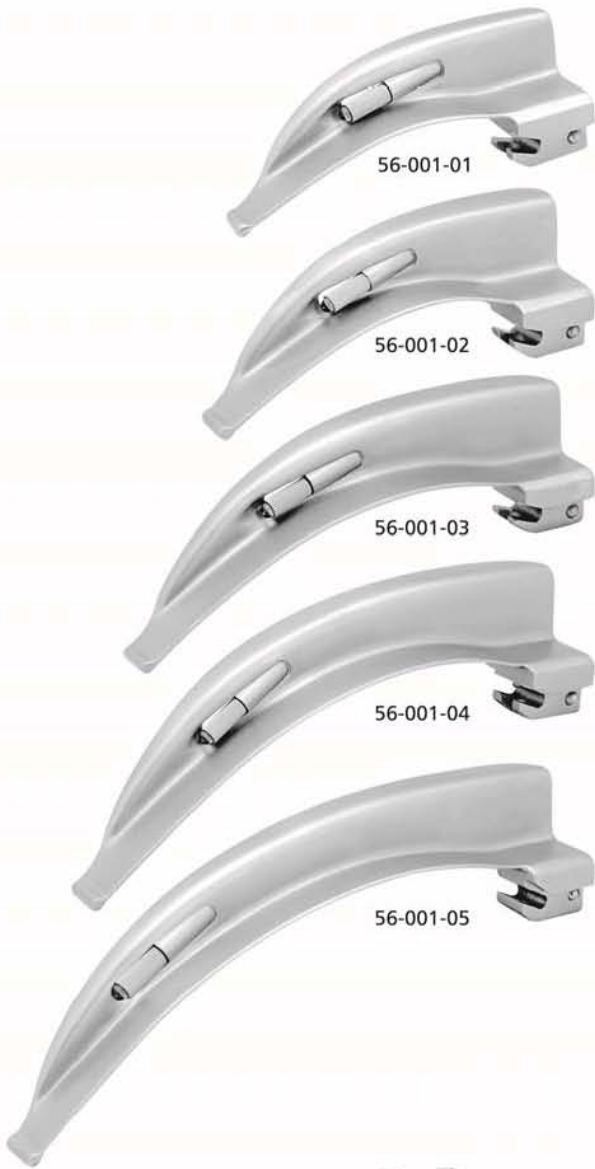

MACINTOSH - ENGLISH PROFILE

PRODUCT CODE	Size	Description	Overall Length A (mm)	Distal Width B (mm)
56-001-01	1	Infant	92	14
56-001-02	2	Child	100	17
56-001-03	3	Medium Adult	130	18
56-001-04	4	Large Adult	155	18
56-001-05	5	X-Large Adult	175	24



MEDIUM

LARGE

PRODUCT CODE	Description	Overall Length (mm)	Batteries
56-701-02	Medium	150	2 "C"
56-701-03	Large	175	2 "D"



MACINTOSH LARYNGOSCOPE SET - ENGLISH PROFILE

57-801-01 1 Medium Handle, 4 MacIntosh Blades (1,2,3,4),
1 Spare Lamp, 2 "C" Batteries



MILLER LARYNGOSCOPE SET - ENGLISH PROFILE

57-803-01 1 Medium Handle, 4 Miller Blades (1,2,3,4),
1 Spare Lamp, 2 "C" Batteries



MACINTOSH LARYNGOSCOPE SET - ENGLISH PROFILE

56-801-01 1 Medium Handle, 4 MacIntosh Blades (1,2,3,4),
2 Spare Lamps, 2 "C" Batteries



MILLER LARYNGOSCOPE SET - ENGLISH PROFILE

56-803-01 1 Medium Handle, 4 Miller Blades (1,2,3,4),
2 Spare Lamps, 2 "C" Batteries

TONGUE HOLDING FORCEPS, UTERINE FORCEPS
 ZUNGEN ZANGEN, UTERUS-ZANGEN
 PINZAS TIRA-LENGUA, PINZAS PARA UTERINOS

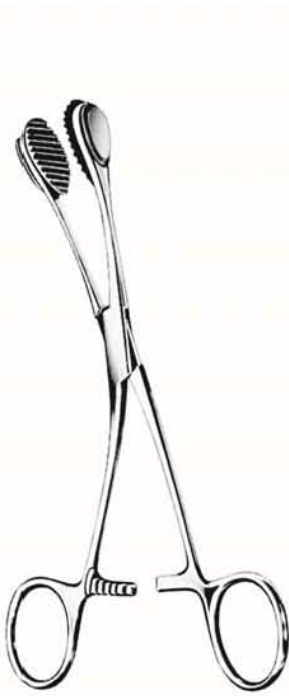

51-0458-17
 17.0 cm
 YOUNG



51-0459-30
 UTERUS PUMP
 PIPE 300 cm

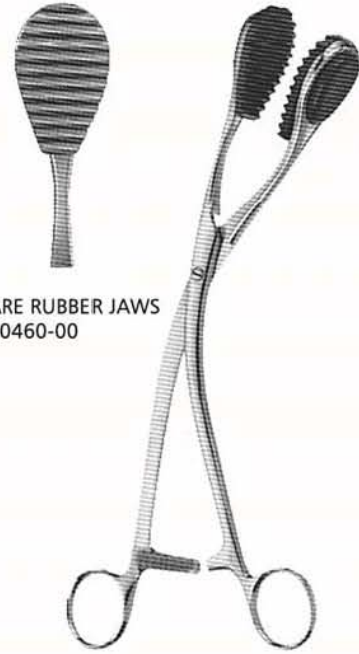

SPARE RUBBER JAWS
 51-0460-00

51-0458-28
 28.0 cm
 UTERUS FORCEPS

VAGINAL SPECULA
 SCHEIDENSPEKULA
 ESPECULOS VAGINALES

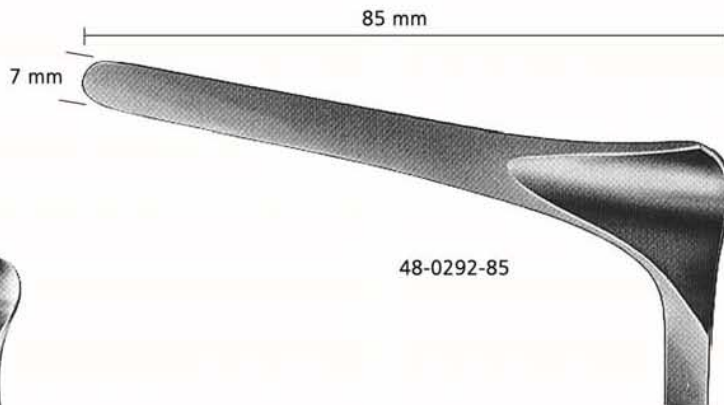

48-0292-85

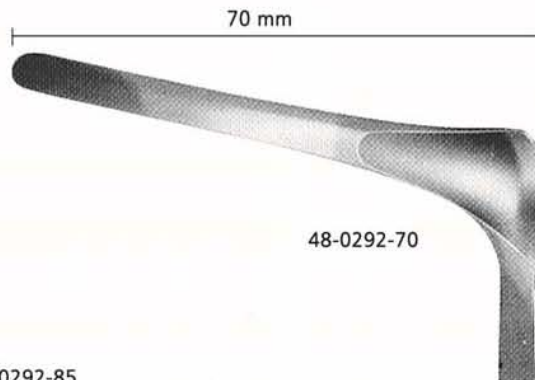

48-0292-70

48-0292-70 - 48-0292-85
 14.0 cm
 KILLIAN

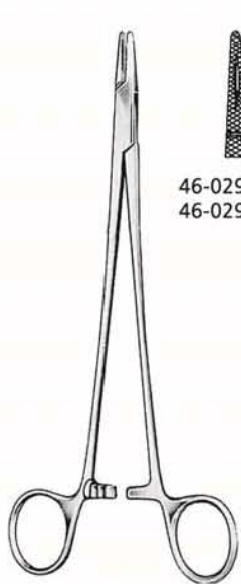

46-0292-15 15.0 cm
46-0296-18 18.0 cm

46-0292-15 - 46-0296-18
CRILE-WOOD

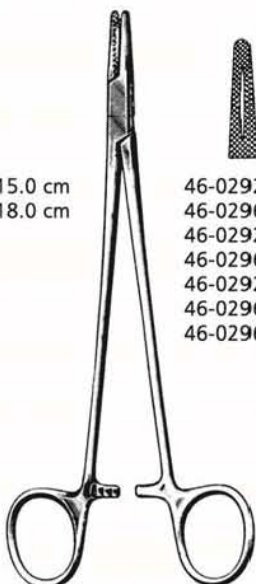

46-0292-14 14.0 cm
46-0296-16 16.0 cm
46-0292-18 18.0 cm
46-0296-20 20.0 cm
46-0292-24 24.0 cm
46-0296-26 26.0 cm
46-0296-30 30.0 cm

46-0292-14 - 46-0296-30
MAYO-HEGAR

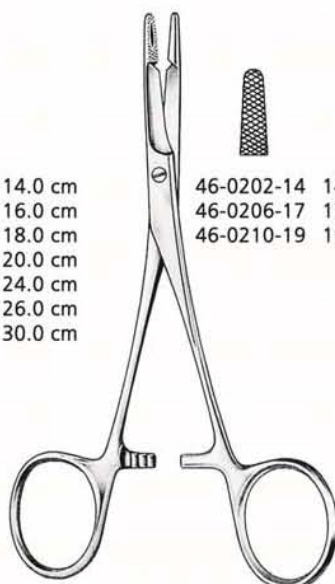

46-0202-14 14.0 cm
46-0206-17 17.0 cm
46-0210-19 19.0 cm

46-0202-14 - 46-0210-19
OLSEN-HEGAR

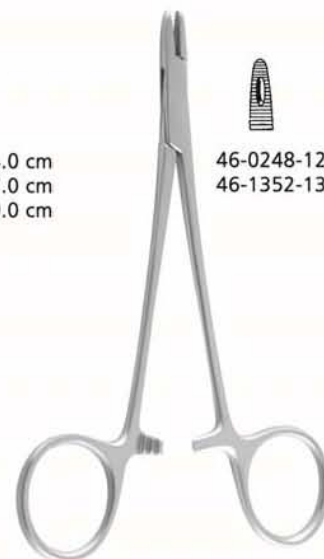

46-0248-12 12.0 cm
46-1352-13 13.0 cm

46-0248-12 - 46-1352-13
DERF



46-0661-14 14 cm
46-0662-18 18 cm

46-0665-14 14 cm
46-0666-18 18 cm

46-0661-14 - 46-0666-18
CASTROVEIJO



46-0144-14 14.0 cm
46-0148-17 17.0 cm
46-0152-20 20.0 cm
46-0152-24 24.0 cm

46-0144-14 - 46-0152-24
MATHIEU

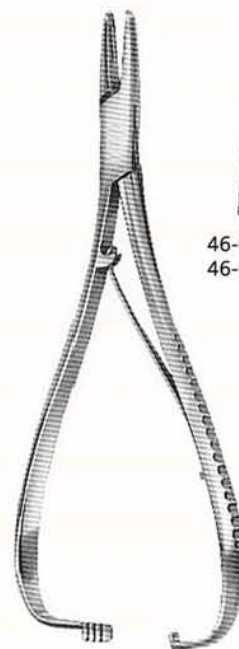

46-0153-18 18.0 cm
46-0155-20 20.0 cm

46-0153-18 - 46-0155-20
MATHIEU-STILLE

NEEDLE HOLDERS WITH TUNGSTEN CARBIDE INSERTS
 NADELHALTER MIT HARTMETALLEINSATZEN
 PORTA - AGUJAS CON BOCAS DE CARBURO DE TUNGSTENO

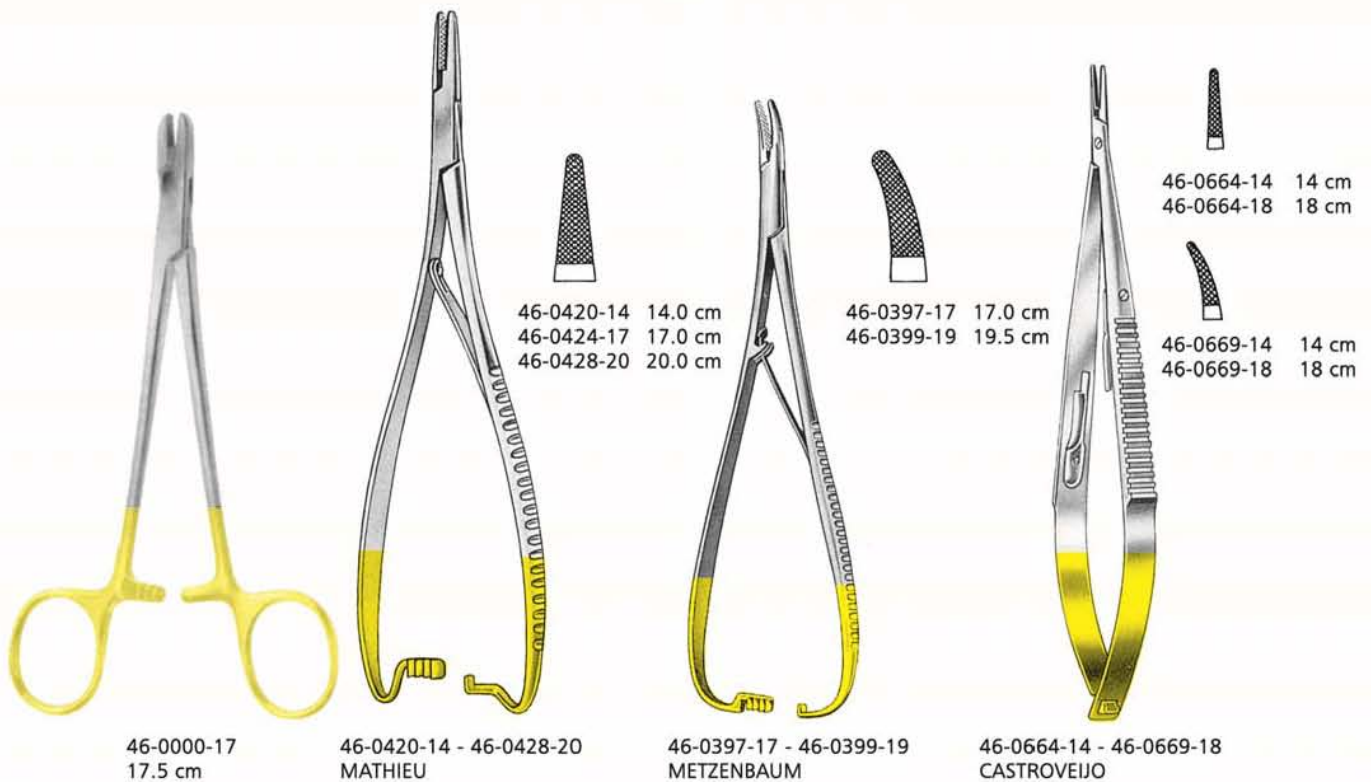
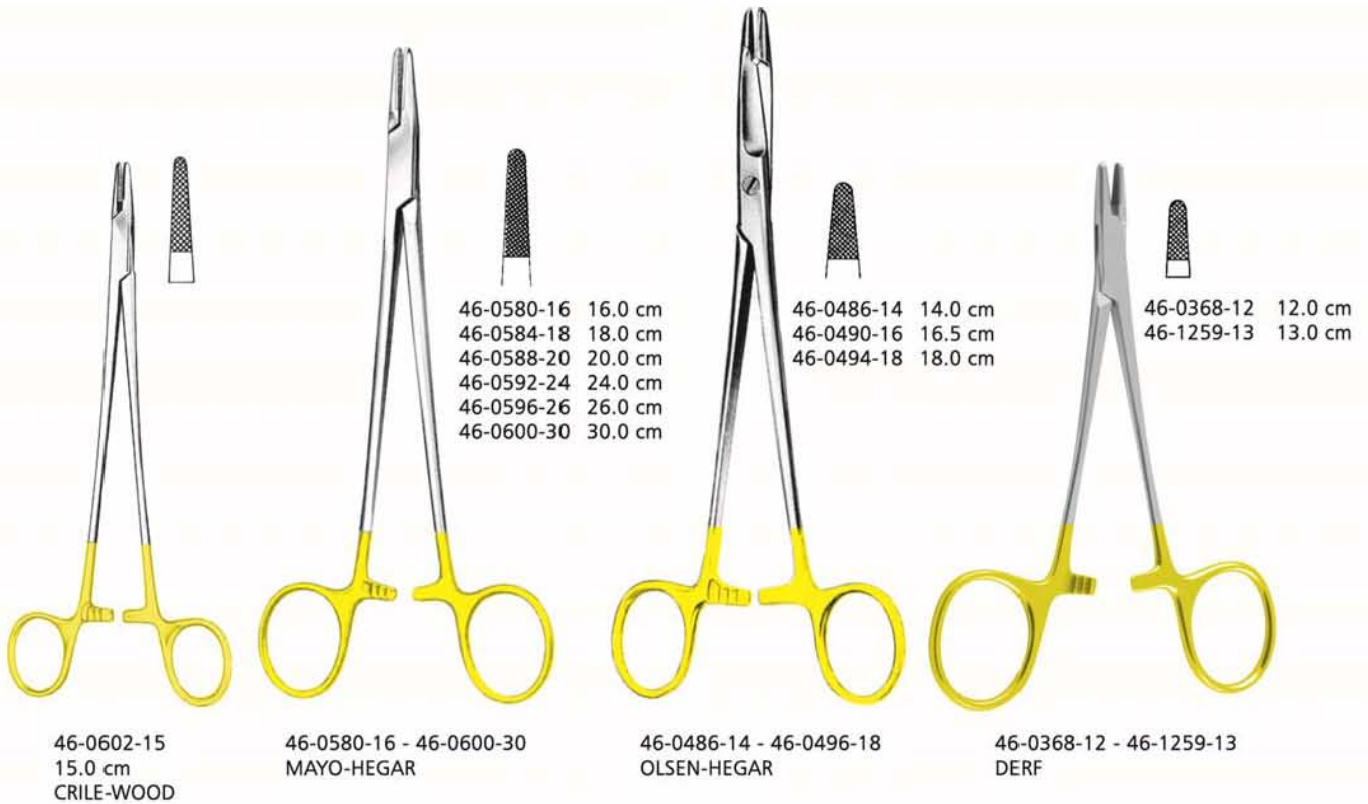



46-1292-30
30.0 cm
BUHNER



46-1292-19
19.0 cm
MODEL GERLACH



46-1292-20
20.0 cm
FLESSA NEEDLE



54-0150-11 11.5 cm
54-0154-13 13.0 cm
54-0158-14 14.5 cm
54-0162-16 16.0 cm
54-0166-18 18.0 cm
54-0170-20 20.0 cm
54-0170-25 25.0 cm
1.5 mm Ø



54-0126-11 11.5 cm
54-0130-13 13.0 cm
54-0134-14 14.5 cm
54-0138-16 16.0 cm
54-0142-18 18.0 cm
54-0146-20 20.0 cm
54-0146-25 25.0 cm
2.0 mm Ø



54-0114-11 11.5 cm
54-0114-13 13.0 cm
54-0118-14 14.5 cm
54-0122-16 16.0 cm
54-0122-18 18.0 cm
54-0122-20 20.0 cm



51-0620-12 12.0 cm 0.9 mm Ø
51-0624-14 14.0 cm 0.9 mm Ø
51-0626-16 16.0 cm 1.1 mm Ø
51-0626-18 18.0 cm 1.2 mm Ø
FARRELL (LATHBURY-UEBE)

BONE CURETTES, BONE CUTTING FORCEPS
 SCHARFE LOFFEL, KNOCHENSPLITTERZANGEN
 CUCHARILLAS CORTANTES, PINZAS CORTANTES PARA HUESOS



46-0602-24
6.8 mm
FIG. 2

46-0602-24
24.0 cm
SIMON



46-0603-24
10.0 mm
FIG. 3

46-0603-24
24.0 cm
SIMON

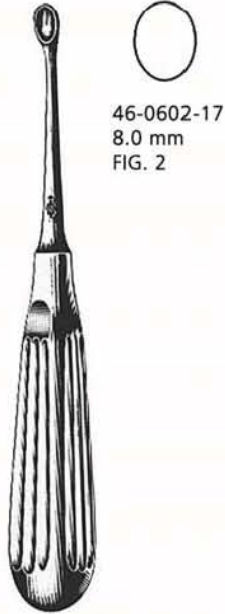

46-0602-17
8.0 mm
FIG. 2

46-0602-17
17.0 cm
VOLKMANN

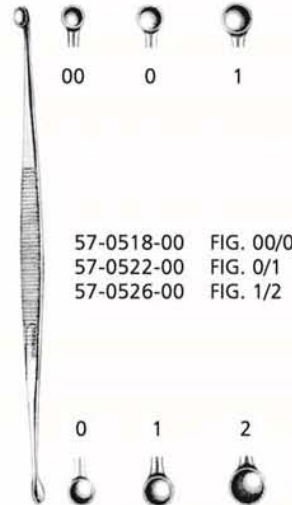

57-0518-00 FIG. 00/0
57-0522-00 FIG. 0/1
57-0526-00 FIG. 1/2

57-0518-00 - 57-0526-00
14.0 cm
MARTINI

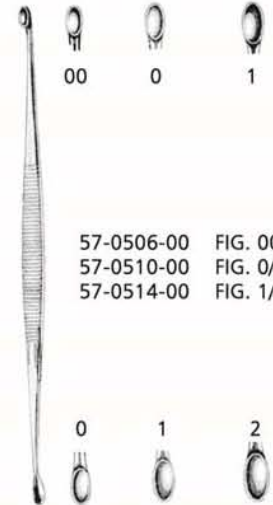

57-0506-00 FIG. 00/0
57-0510-00 FIG. 0/1
57-0514-00 FIG. 1/2

57-0506-00 - 57-0514-00
14.0 cm
WILLIGER

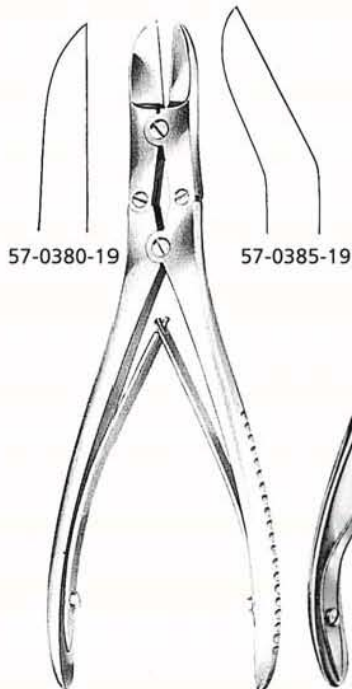

57-0380-19 - 57-0385-19
19.0 cm
RUSKIN-LISTON



57-0277-14
14.0 cm



57-0131-14
14.0 cm
FRIEDMAN



57-0131-22
22.0 cm
WIRE CUTTING PLIERS

57-0131-23
23.5 cm
WIRE CUTTING PLIERS



46-0292-16
16.0 cm
with wooden handle



46-0292-22
22.0 cm
with wooden handle



46-0292-25
25.0 cm
with wooden handle



46-0293-25
25.0 cm
with metal handle

spare cannula
54-0127-11
Ø 4 x 100 mm
54-0131-13
Ø 7 x 120 mm
54-0135-14
Ø 10 x 150 mm

spare cannula
54-0139-14
Ø 7 x 120 mm

spare cannula
54-0143-14
Ø 4 x 100 mm



TROCARS
with 1 cannula
and wooden handle
54-0126-12
Ø 7 x 120 mm
54-0130-15
Ø 10 x 150 mm
54-0134-10
Ø 4 x 100 mm



TROCARS
with 1 cannula
and metal handle
54-0138-11
Ø 7 x 120 mm



TROCARS
with 1 cannula
and metal handle
54-0142-14
Ø 4 x 100 mm



46-1020-23
23.0 cm



46-1022-19
19.0 cm



46-0292-23 23.0 cm
46-0293-26 26.0 cm
FARABEUF



57-1116-13 13.0 cm
57-1120-18 18.5 cm
57-1124-20 20.0 cm
LOWMAN

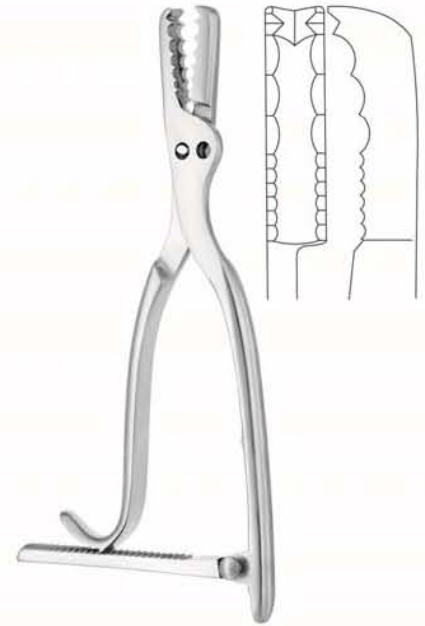

57-1112-26
26.0 cm
FARABEUF-LAMBOTTE



46-1026-24
24 cm
CASTRATION FORCEPS



46-0664-09
9.5 cm



46-0664-17
17.0 cm
REILL



46-0664-05
20.0 cm

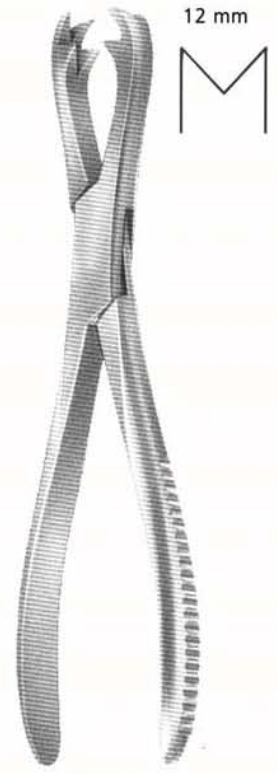

46-0664-12
20.5 cm
FERGUSSON

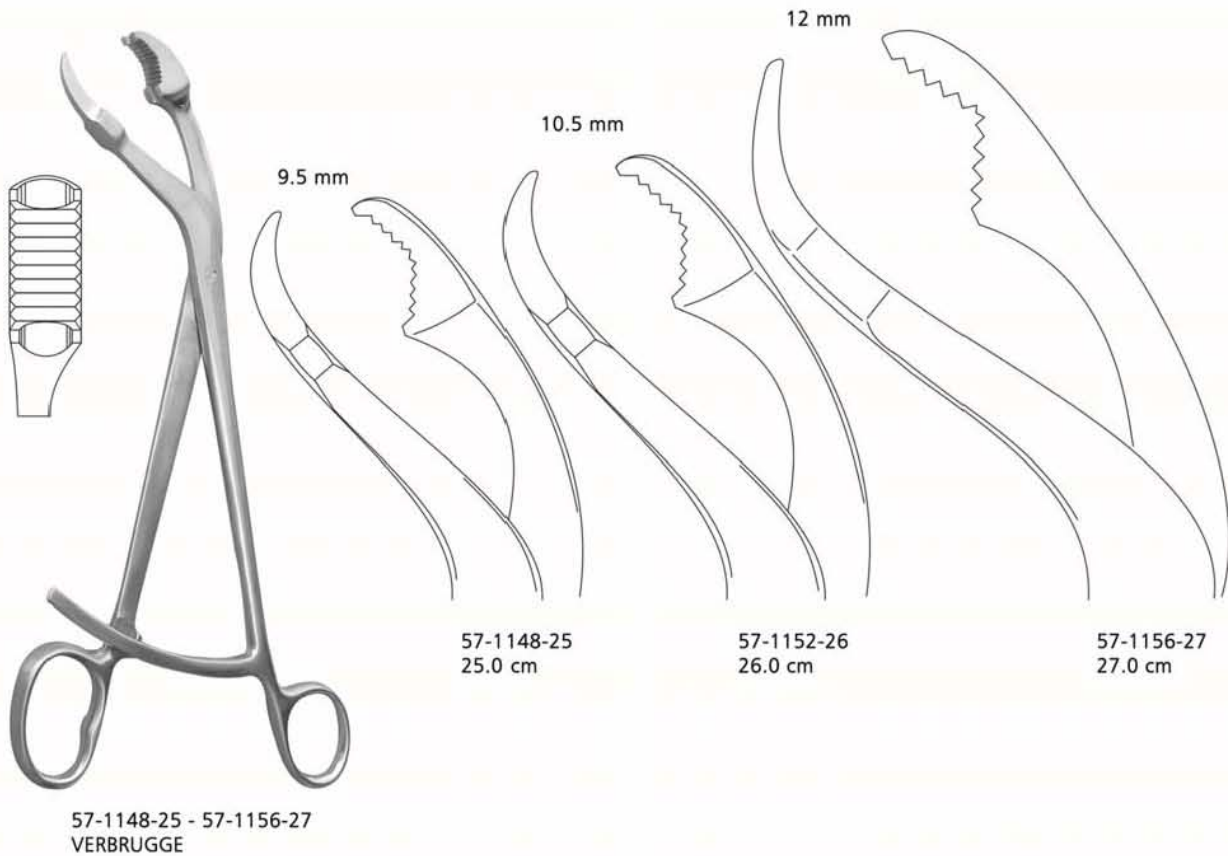
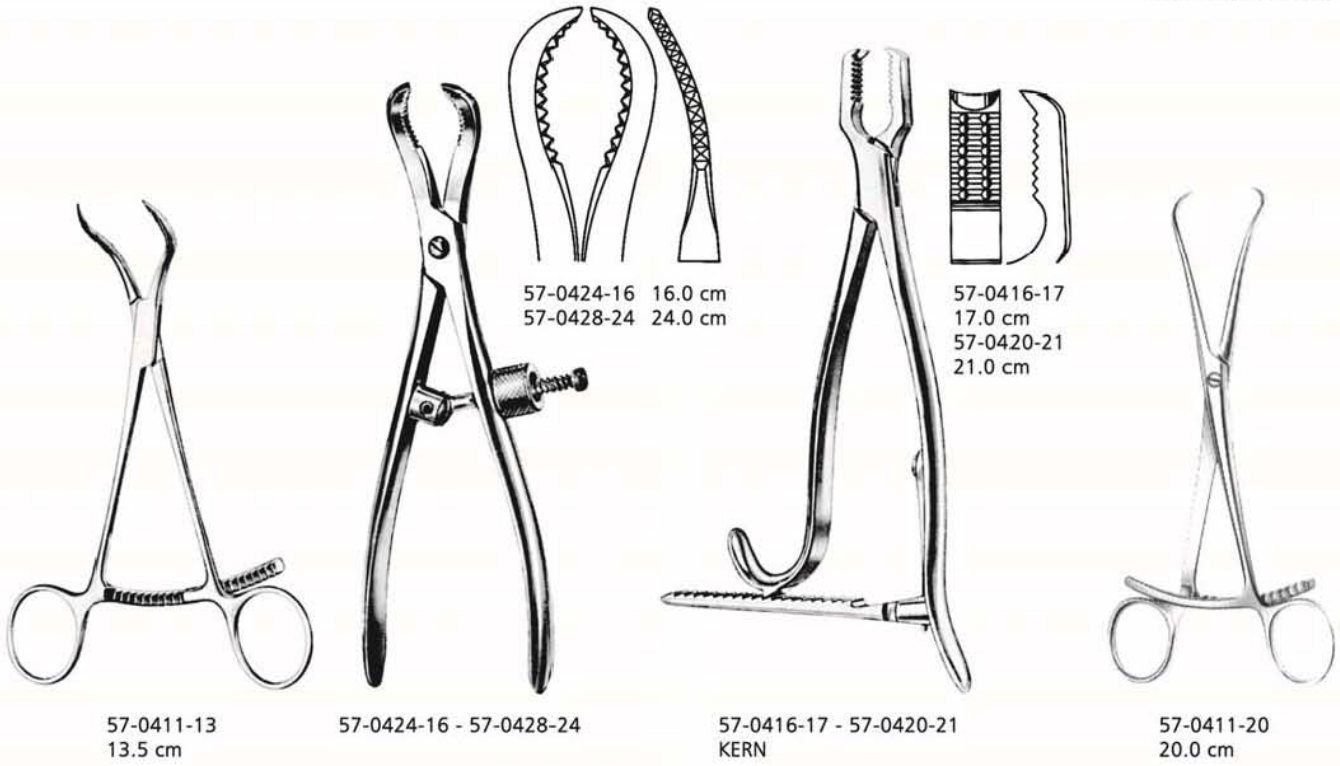



57-1260-10
BONE CHISEL
10 mm



57-1262-20
SPONLOSA GOUGES
LEXER
TIP 5 mm



57-1264-18
PERIOSTEEL ELEVATOR
18.5 cm, TIP 3 mm
57-0000-19
19 cm, TIP 6 mm



57-1266-16
PERIOSTEEL ELEVATOR
16 cm, TIP 6 mm



57-1268-30
30 cm
TIP 3 mm



57-1270-24
24.0 cm



57-1272-15
15.0 cm



57-1274-00
MALLET
135 gm

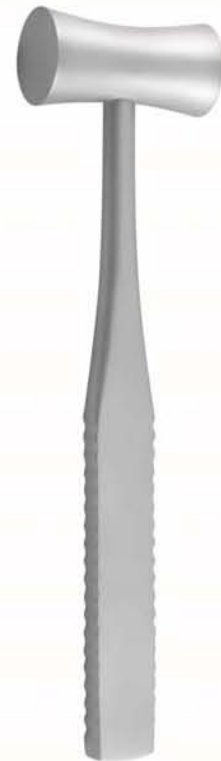

57-1276-00
MALLET
245 gm

STRAIGHT
 GERADE
 RECTO



46-0290-19 19.0 cm
 46-0290-23 23.0 cm
 HAUSSMANN

STRAIGHT
 GERADE
 RECTO

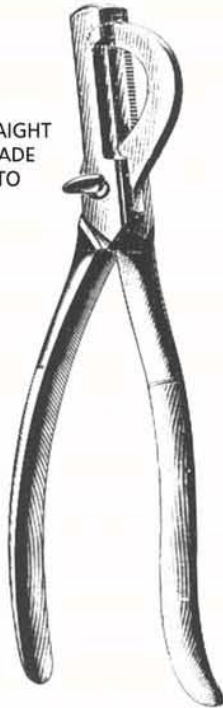

46-0292-19 19.0 cm
 46-0293-27 27.0 cm
 HAUSSMANN

CURVED
 GEBOGEN
 CURVA



46-0294-27 27.0 cm
 46-0294-31 31.0 cm
 HAUSSMANN



46-0295-31 31.0 cm
 SAND



46-0292-33 33.0 cm
 REIMERS



46-0296-31 31.0 cm
 MASCH



51-0411-36 36.0 cm
 SERRA



51-0412-36 36.0 cm
 SERRA

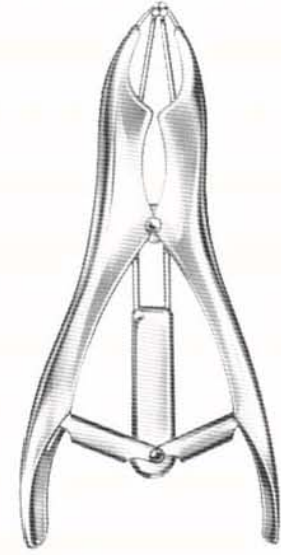

51-0411-22 22.0 cm
 APPLICATOR



51-0411-23 23.0 cm
 BURDIZZO



51-0411-30 30.0 cm
 51-0411-34 34.0 cm
 BURDIZZO



51-0411-40 40.0 cm
 51-0411-45 45.0 cm
 BURDIZZO



PIG HOLDER WITH HANDLE
51-0511-00



46-0292-26 26.0 cm



46-0155-01
Ø 51 mm
(INSIDE DIAMETER WITH SAFETY SCREW)



46-0155-02
Ø 29 mm
(INSIDE DIAMETER WITH SAFETY SCREW)



46-0155-03
Ø 57 mm
(INSIDE DIAMETER WITH SAFETY SCREW)



51-0413-36
BULL HOLDER

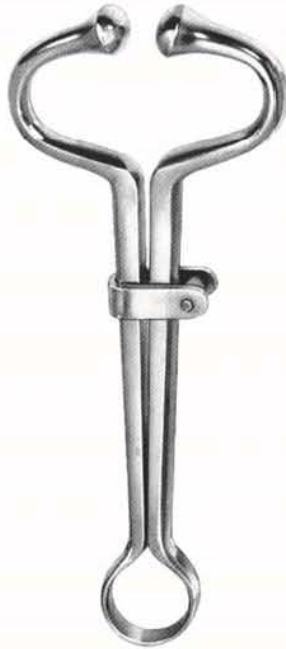

51-0411-18
18.5 cm
HARMS



51-0414-18
18.5 cm
HARMS



51-0415-11
11.0 cm
BULL HOLDER



51-0411-44
44.0 cm
NOSE FORCEPS



51-0416-23
ANTI KICK BAR FOR CATTLE



51-1412-00



51-0417-36
SCHOTTLE
PIG NOSE TWITCH

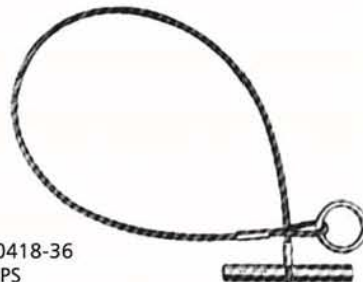

51-0418-36
TROPS
PIG NOSE TWITCH



51-0419-36
CHRISTOPH



51-1414-00
1 meter length
DOG LASSO



51-0411-37
37.0 cm
NOSE TWITCH



51-0420-37
BRON
CLAMP



LIGHT PATTERN
 LEICHTES MODELL
 MODELO LIGERAMENTE

57-0200-19
 19.0 cm
 SAND



STRONG PATTERN
 STARK MODELL
 MODELO FUERTO

57-1201-19
 19.0 cm
 SAND

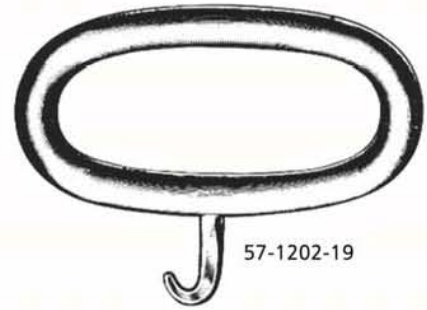

57-1202-19



57-0200-80
 80.0 cm



57-0201-19
 190.0 cm



57-0200-06
 6.5 cm
 OSTERTAG
 BLUNT - STUMPF - ROMO



57-0200-08
 8.0 cm
 HARM
 BLUNT - STUMPF - ROMO



57-0201-08
 8.0 cm
 HARM
 SHARP - SCHARF - AGUDO



57-0200-14
 14.0 cm
 RUGGEBERG

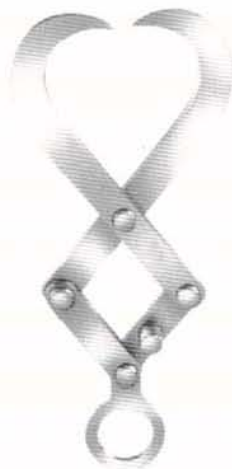

46-0155-21
 21.0 cm
 KREY-SCHOTTLER



46-0155-10
 10.5 cm
 LINDE



46-0155-07
 7.5 cm
 TAPKEN



46-0157-07
 OBSTETRIC HANDLE



46-0155-14
 14.0 cm
 MODELL WIEN



51-0411-20
20.0 cm
DANISCHES MODELL



51-0411-52
52.0 cm
WITT



51-0411-50
50.0 cm
HOHMANN



51-0421-21 21.0 cm
51-0421-25 25.0 cm
51-0421-30 30.0 cm
51-0421-60 60.0 cm
PAHLSON MODEL
OBSTETRIC FORCEPS



51-1411-28
28.0 cm
NIEMAND

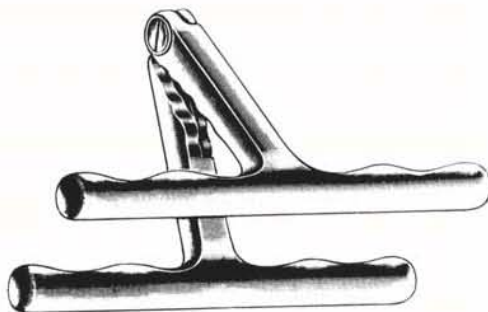

51-0422-28
HANDLES FOR EMBRYOTOMY WIRE SAWS



51-0411-85 85.0 cm
51-0411-100 100.0 cm
EMBRYOTOME

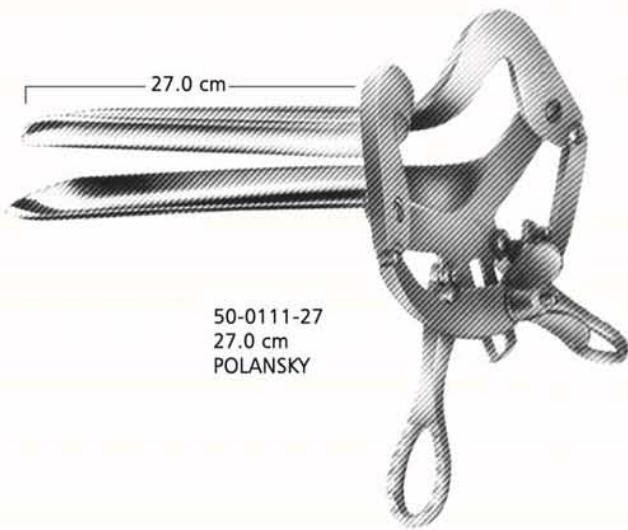

50-0111-27
 27.0 cm
 POLANSKY

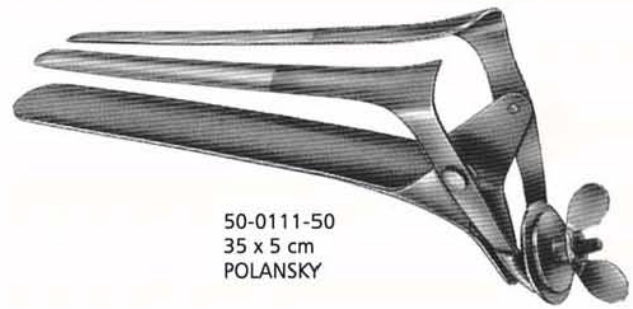

50-0111-50
 35 x 5 cm
 POLANSKY









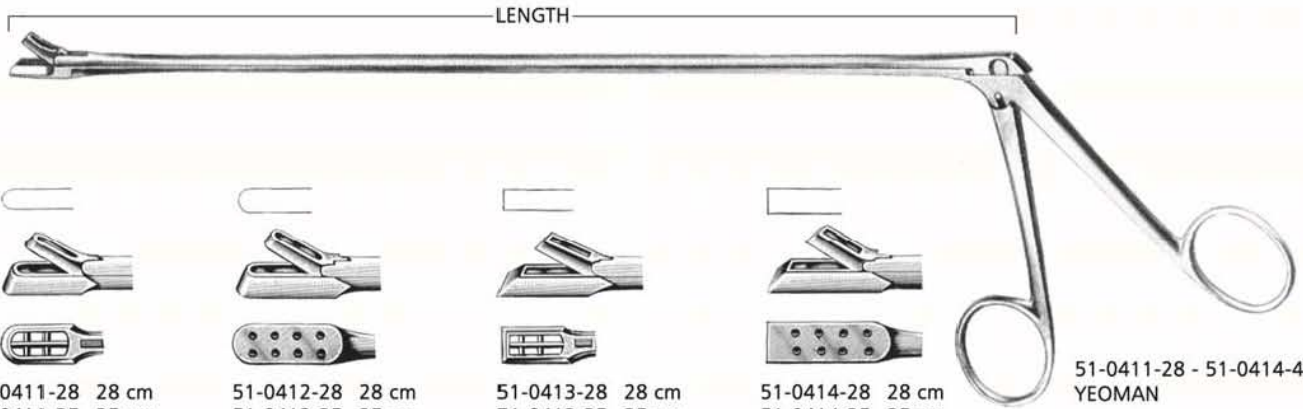

50-0112-16 16 cm
 50-0112-27 27 cm
 50-0112-35 35 cm
 (BLADE SIZE)



50-0111-01 21 mm Ø x 50 mm
 50-0111-02 27 mm Ø x 50 mm
 50-0111-03 22 mm Ø x 100 mm
 50-0111-04 22 mm Ø x 140 mm
 KELLY



51-0411-28 - 51-0414-42
 YEOMAN

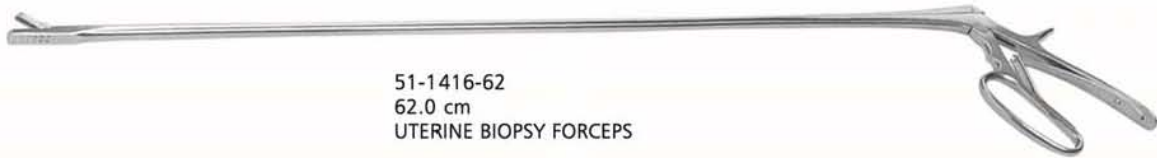

			
			
51-0411-28 28 cm	51-0412-28 28 cm	51-0413-28 28 cm	51-0414-28 28 cm
51-0411-35 35 cm	51-0412-35 35 cm	51-0413-35 35 cm	51-0414-35 35 cm
51-0411-42 42 cm	51-0412-42 42 cm	51-0413-42 42 cm	51-0414-42 42 cm



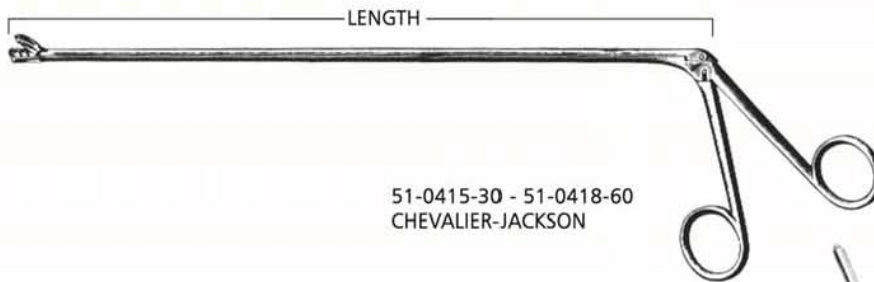

51-1416-62
 62.0 cm
 UTERINE BIOPSY FORCEPS



51-0415-30 - 51-0418-60
 CHEVALIER-JACKSON

	
FIG. 1	FIG. 2
51-0415-30 30 cm	51-0416-30 30 cm
51-0415-40 40 cm	51-0416-40 40 cm
51-0415-50 50 cm	51-0416-50 50 cm
51-0415-60 60 cm	51-0416-60 60 cm

	
FIG. 3	FIG. 4
51-0417-30 30 cm	51-0418-30 30 cm
51-0417-40 40 cm	51-0418-40 40 cm
51-0417-50 50 cm	51-0418-50 50 cm
51-0417-60 60 cm	51-0418-60 60 cm

- 6 51-0411-06
- 8 51-0411-08
- 10 51-0411-10
- 12 51-0411-12

51-0411-06 - 51-0411-12
 19.0 cm
 FRAZIER

51-0411-27
 27.0 cm
 YANKAUER



02-004-02
16.0 cm
MERIAM (SERRATED)



02-009-02
15.0 cm
COLLEGE (SERRATED)



02-001-13
13.0 cm



02-002-13
13.0 cm
PERRY



SIMPLE THREAD
24-063-02 2.0 cm
24-063-03 2.2 cm
24-063-04 2.4 cm
24-063-05 2.6 cm



02-005-01
16.0 cm
HOOK SHAPE



02-005-02
CHISEL



02-005-03
LEFT



02-005-04
RIGHT



02-005-05



02-005-06



02-011-13
13.0 cm
HOLLOW



02-012-13
13.0 cm
SOLID

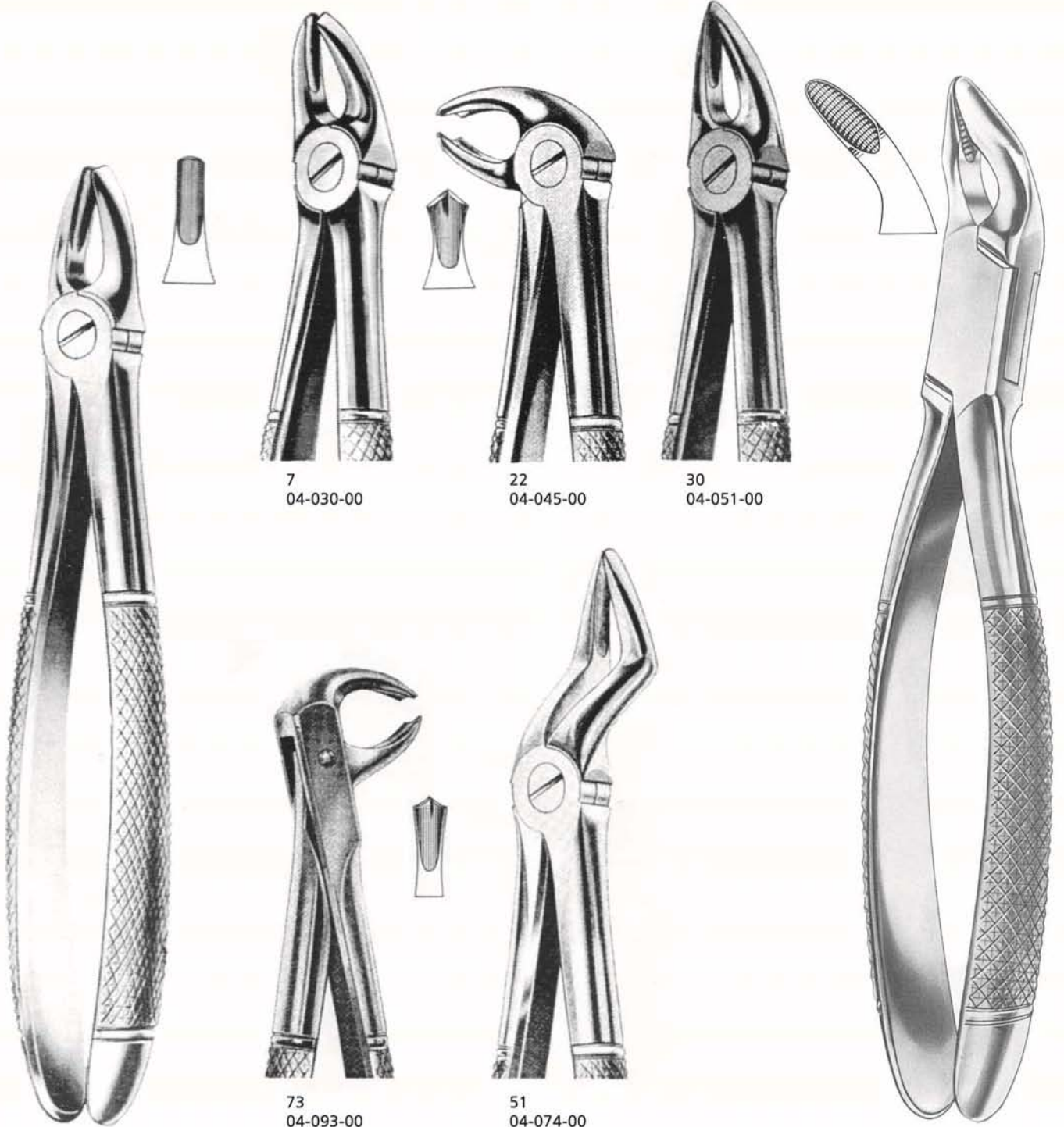

7
04-030-00

22
04-045-00

30
04-051-00

73
04-093-00

51
04-074-00

1
04-024-00

UNIVERSAL TOOTH FORCEPS
04-617-00



137
51-0510-00
KLEIN



150SK
51-0512-00
KLEIN



139
51-0513-00
KLEIN



41
51-0514-00



51-0515-13
13.0 cm
TOOTH CUTTING FORCEPS



51-0516-15
15.0 cm
TOOTH CUTTING FORCEPS

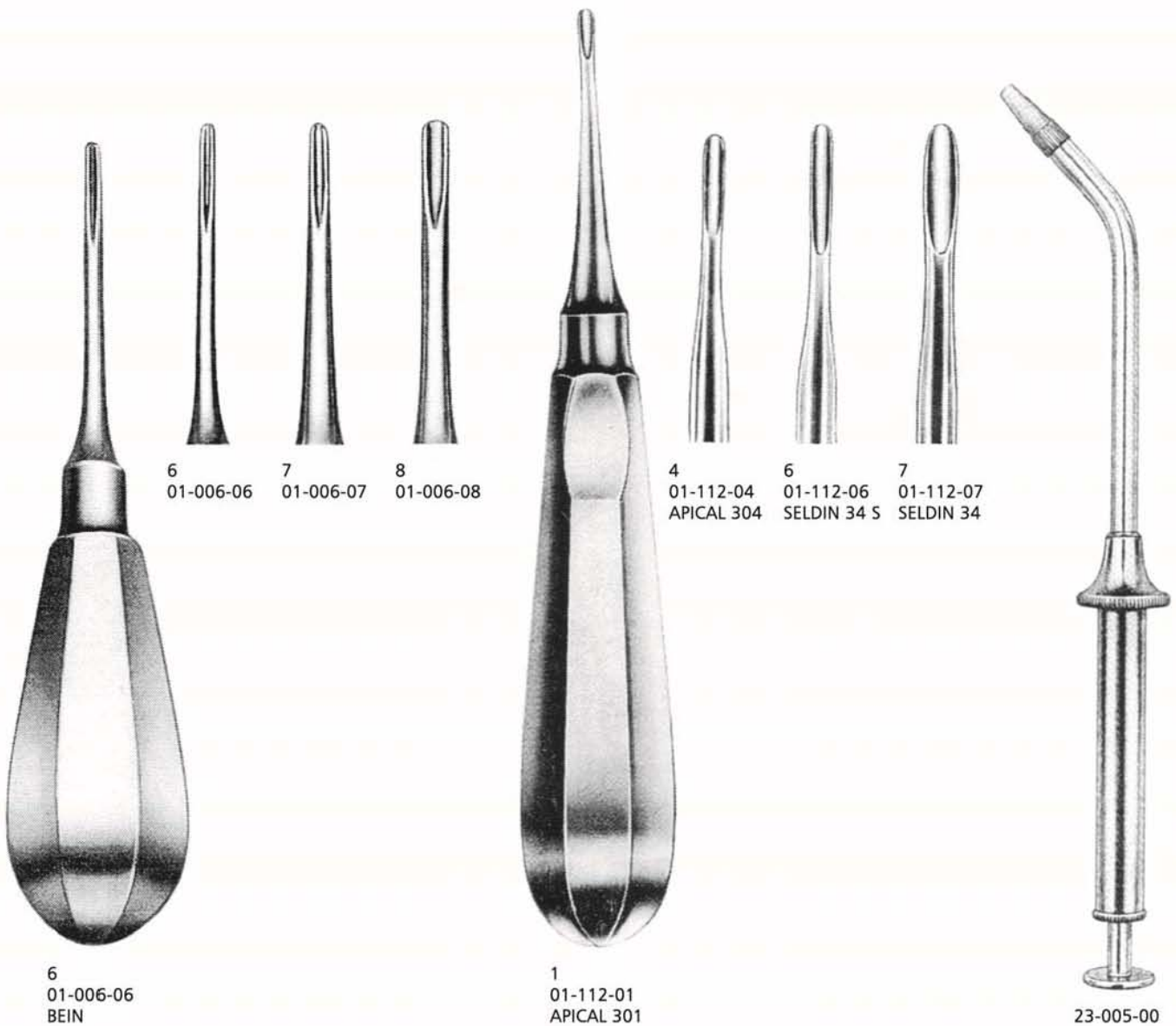

secure EXTRACT



secure EXTRACT

*Give you the confidence,
you have been searching for.*

Non-Slip
&
Maximum Grip



secure
EXTRACT



SE-S1



SE-S2



SE-S3



SE-C3



SE-AC3

NEW

Max GRIP curettes

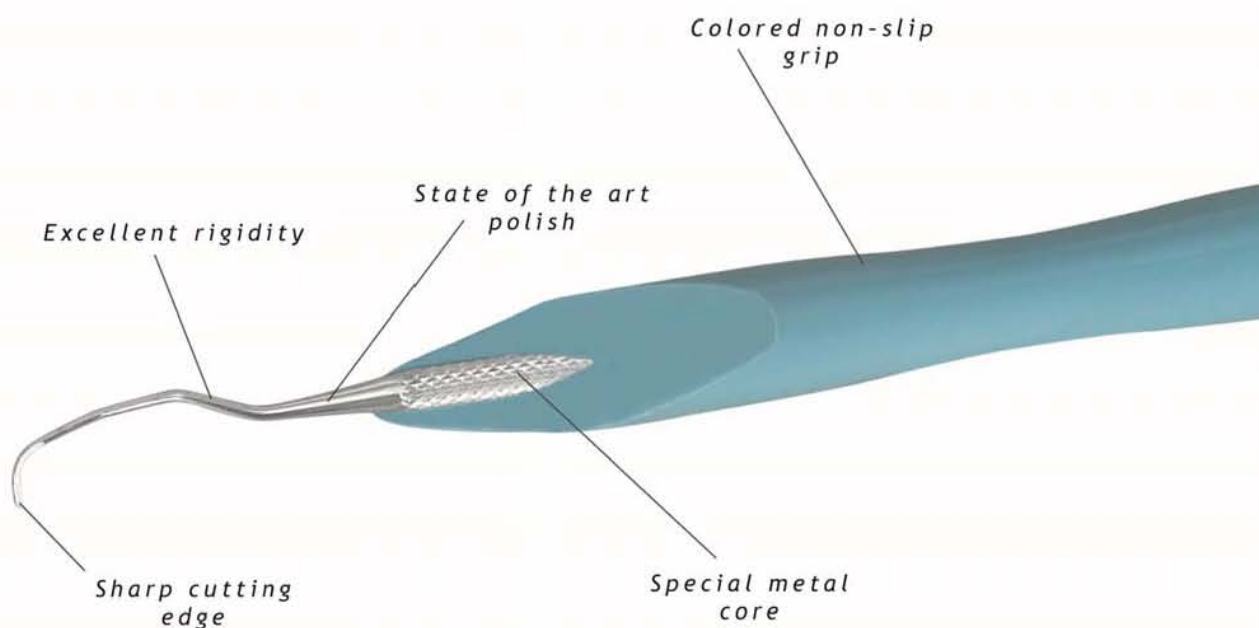

Overall light structure

*Max Grip Instruments can be Sterilized / autoclaved upto 200°C
All other type of periodontal Curettes & hand instruments Including explorers, filling Instruments etc. are available In Max Grip handles.*



Max GRIP curettes

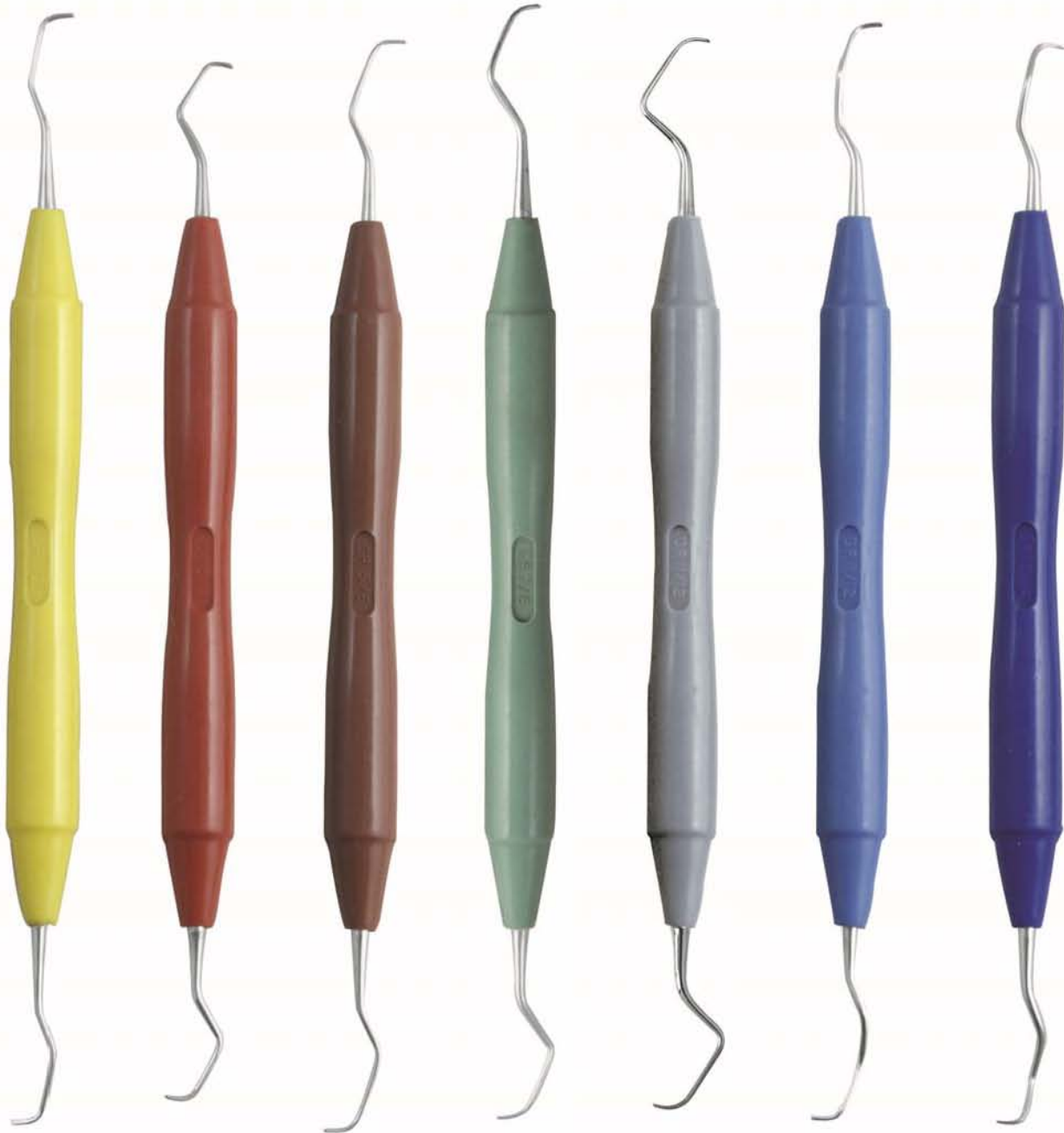

1/2
Gracey
06-075-00

3/4
Gracey
06-076-00

5/6
Gracey
06-077-00

7/8
Gracey
06-078-00

9/10
Gracey
06-079-00

11/12
Gracey
06-080-00

13/14
Gracey
06-081-00

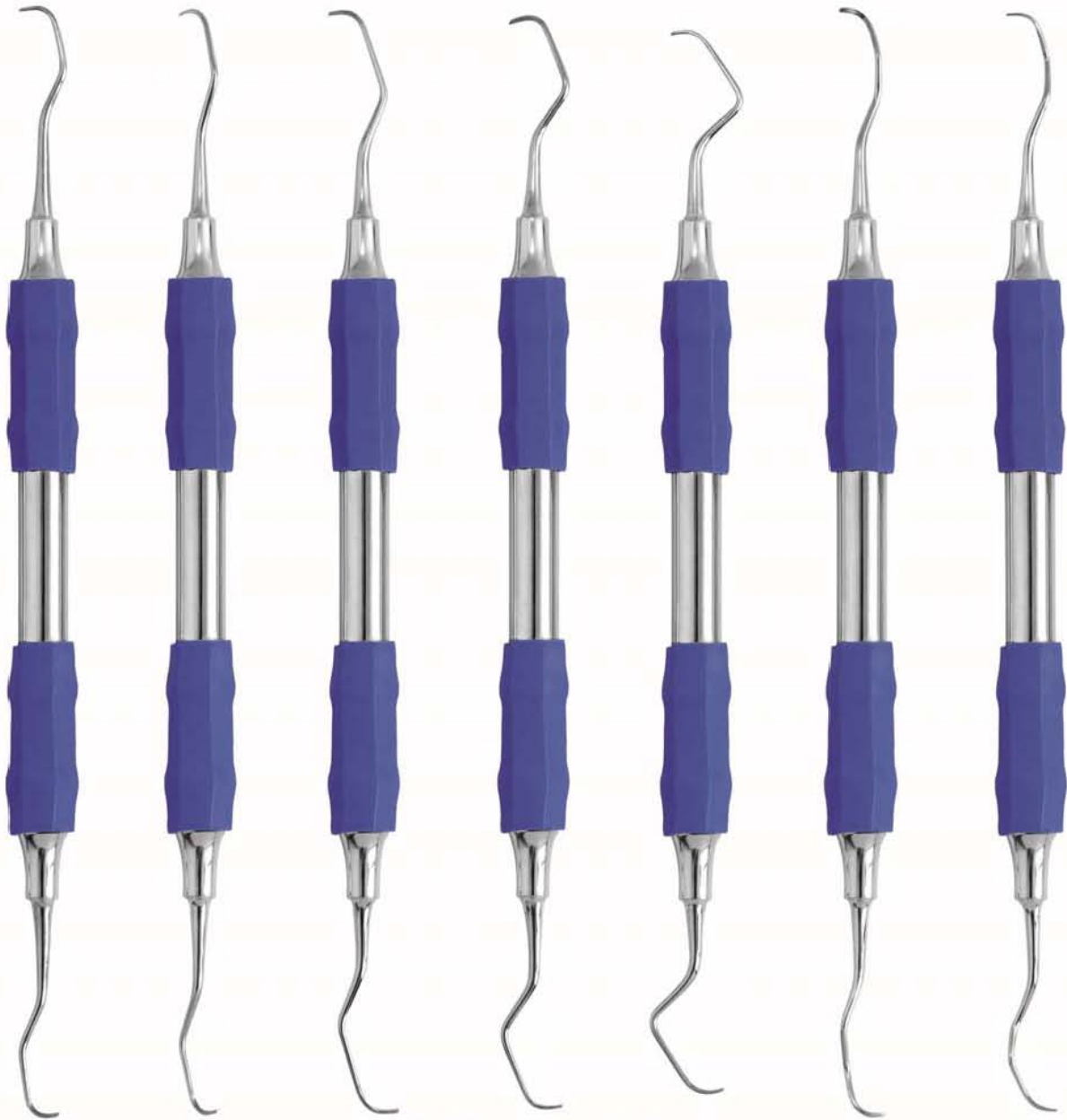

1/2
Gracey
06-120-00

3/4
Gracey
06-121-00

5/6
Gracey
06-122-00

7/8
Gracey
06-123-00

9/10
Gracey
06-124-00

11/12
Gracey
06-125-00

13/14
Gracey
06-126-00



1/2
Gracey
06-108-00



3/4
Gracey
06-109-00



5/6
Gracey
06-110-00



7/8
Gracey
06-111-00



9/10
Gracey
06-112-00



11/12
Gracey
06-113-00



13/14
Gracey
06-114-00

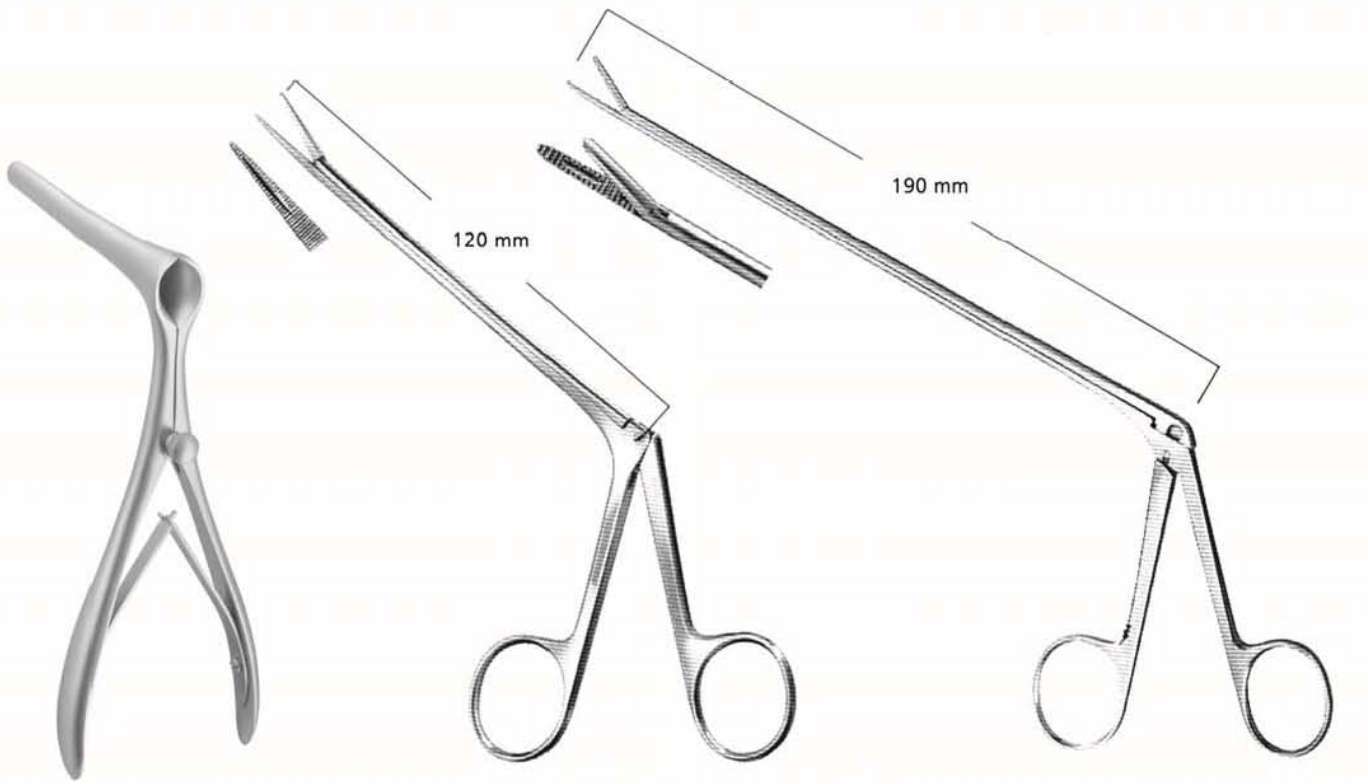

55-1202-09
9 cm
CALIFORNIA

55-0202-12
HARTMANN

55-0202-19
MATHIEU

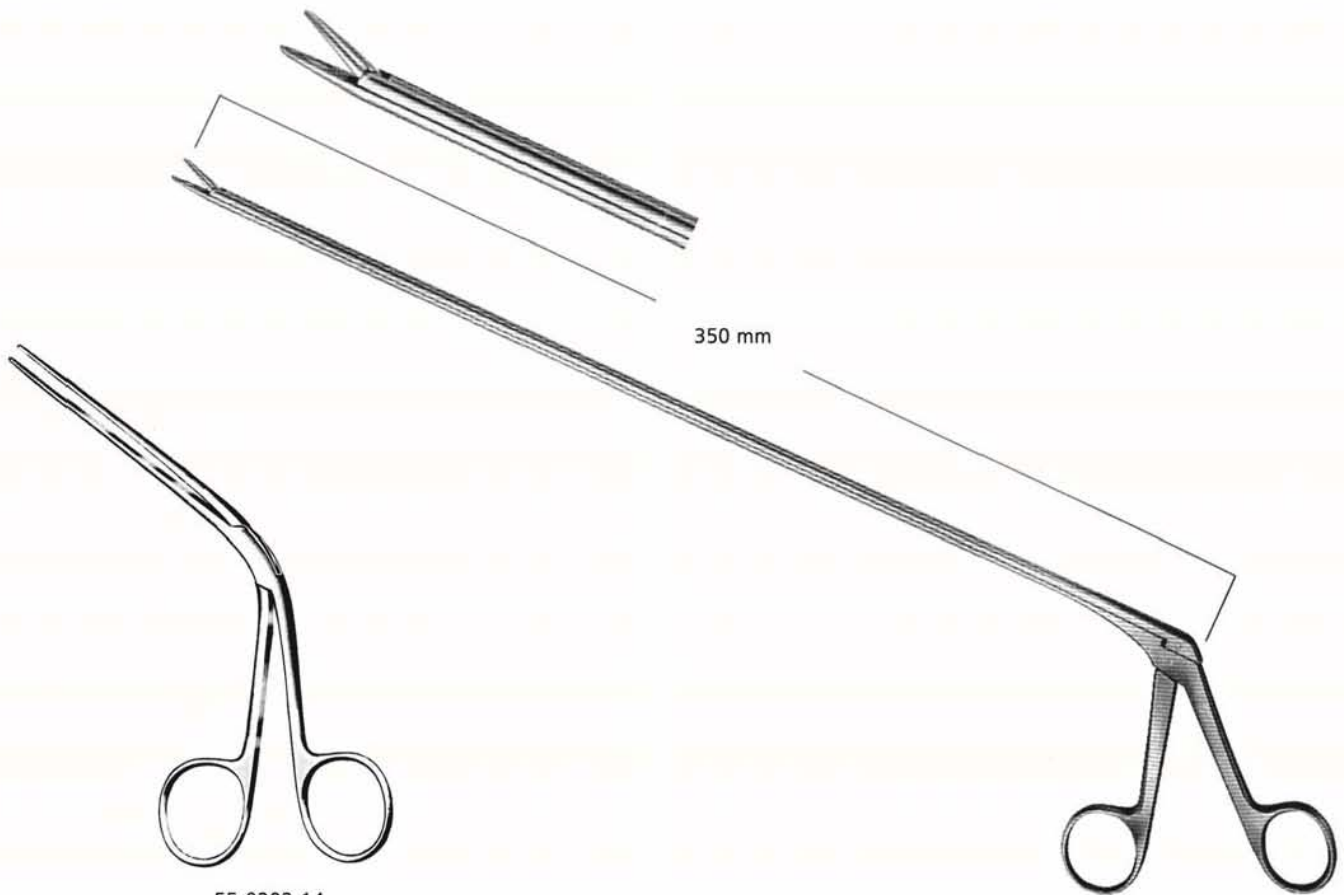

55-0202-14
14 cm
TILLEY

55-0202-35

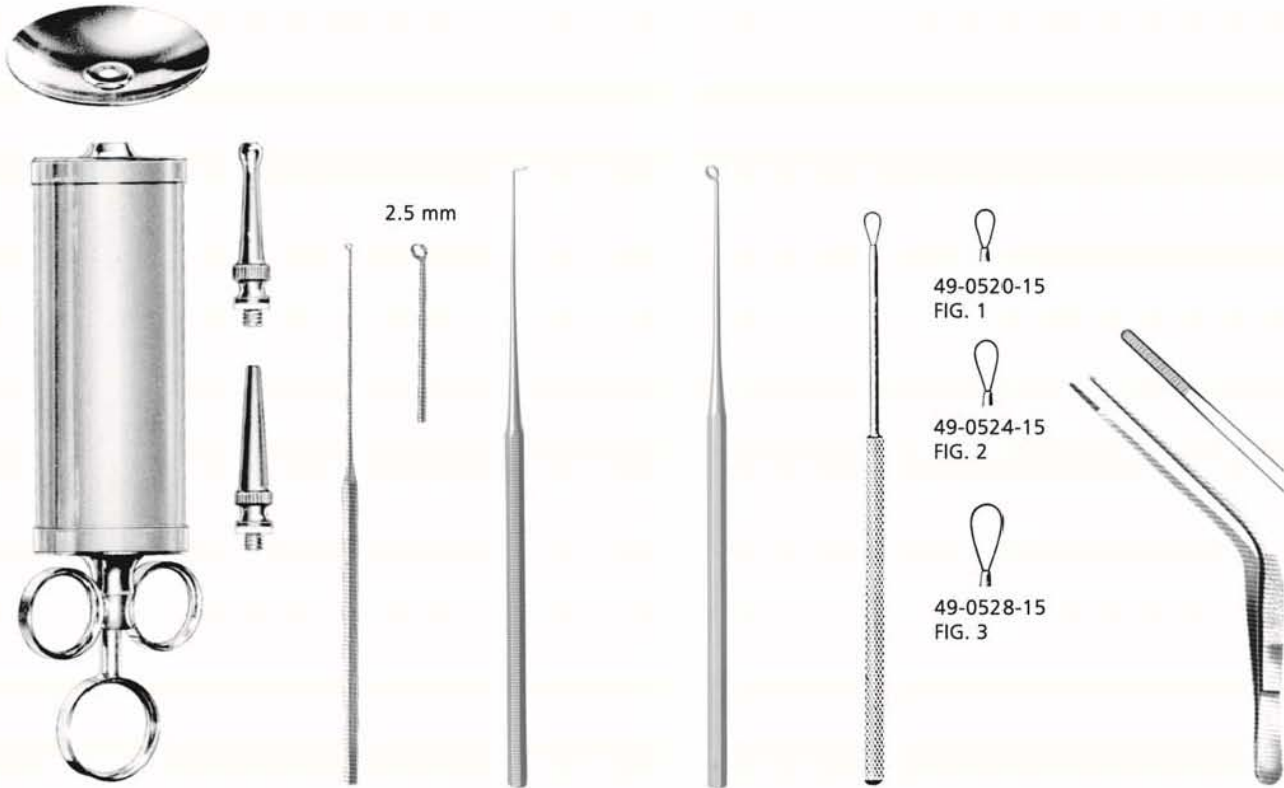

49-0717-01 50 ml
 49-0717-02 100 ml
 49-0717-03 150 ml
 49-0717-04 200 ml
 EAR SYRINGE, COMPLETE

49-0720-00
 EAR CURETTE

49-1714-18
 18 cm
 WAGNER CURETTE

49-1715-18
 18 cm
 BACK CURETTE

49-0520-15 - 49-0528-15
 15.5 cm
 BILLEAU

49-0713-11 11.5 cm
 49-0713-14 14.0 cm
 49-0713-17 17.0 cm
 TROELTSCH

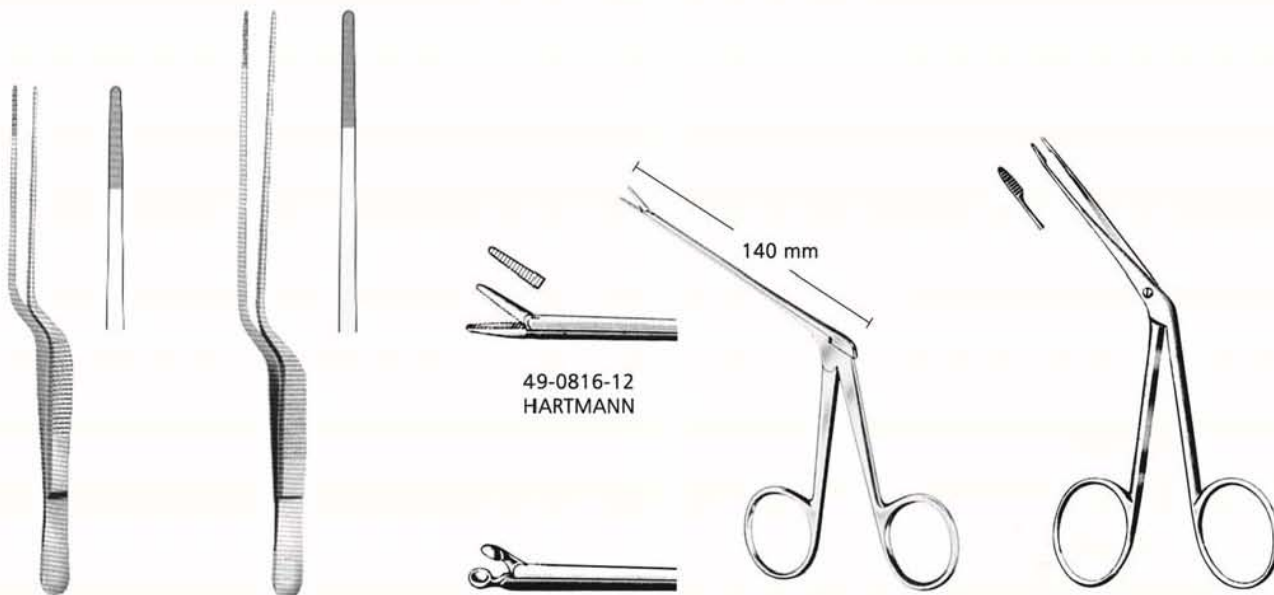

49-0714-14
 14.0 cm
 LUCAE

49-0713-16
 16.0 cm
 JANSEN

49-0816-12
 HARTMANN

49-0840-00
 HARTMANN-HERZFELD

49-0732-13
 13.0 cm
 HARTMANN

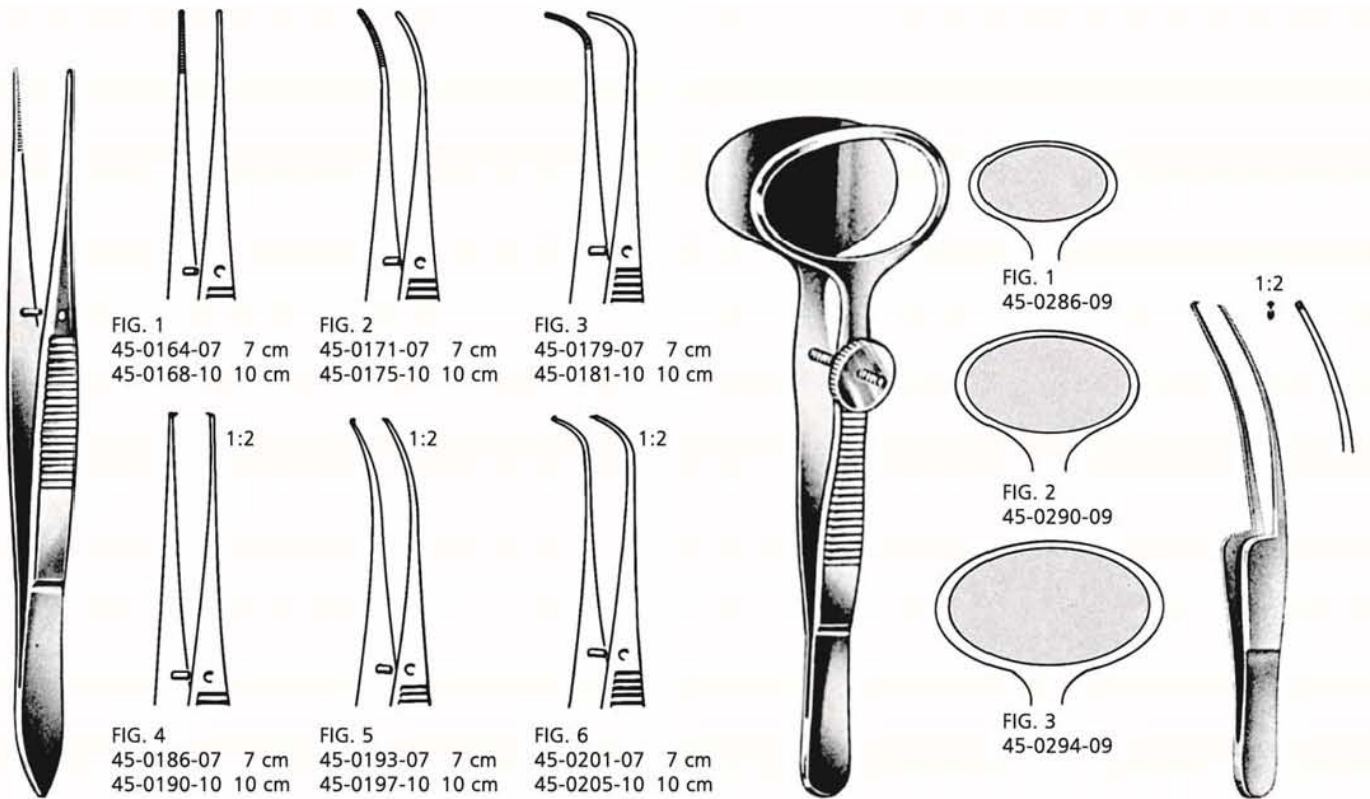

45-0164-07 - 45-0205-10
GRAEFE

45-0286-09 - 45-0294-09
9.0 cm
DESMARRES

45-0249-07
7.0 cm
FISCHER-ARLT

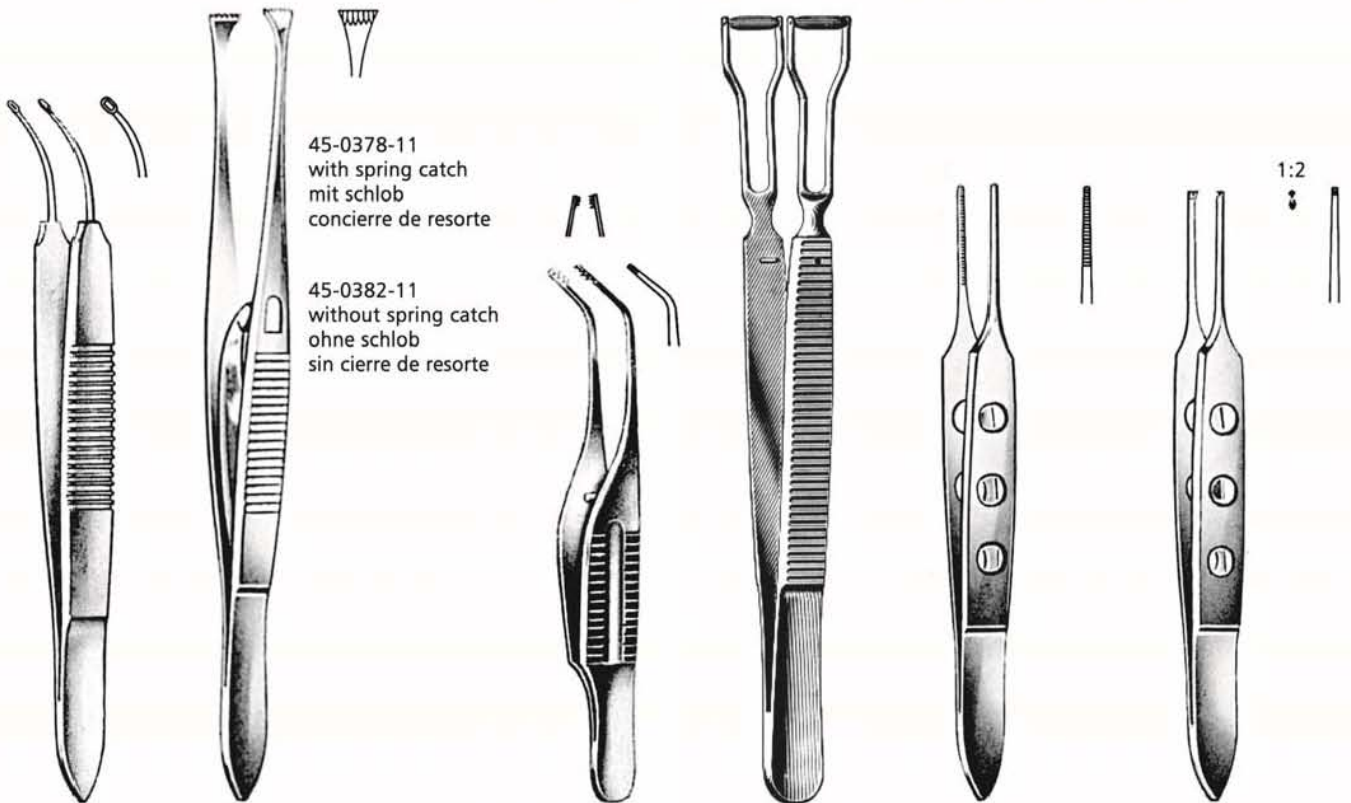

45-0103-10
10.0 cm
ARRUGA

45-0378-11 - 45-0382-11
11.0 cm
GRAEFE

45-0127-07
7.5 cm
GILL-FUCHS

45-0127-11
11.0 cm
KNAPP

45-0256-08
8.5 cm
BISHOP-HARMAN

45-0260-08
8.5 cm
BISHOP-HARMAN

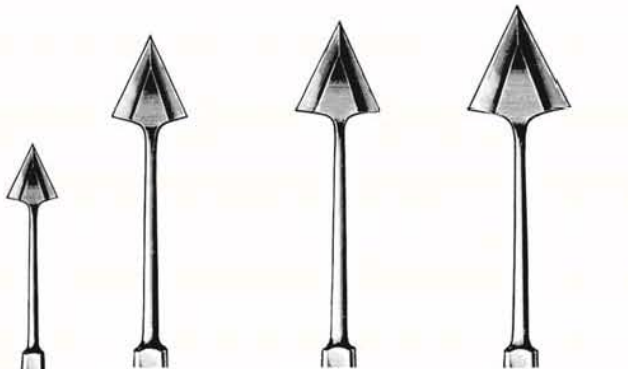

FIG. 1 45-1576-11 9.5 X 11 mm
 FIG. 2 45-1580-12 11 X 12.5 mm
 FIG. 3 45-1584-14 12.5 X 14 mm



JAEGER FIG. 4 45-1591-11 9.5 X 11 mm
 FIG. 5 45-1595-12 11 X 12.5 mm
 FIG. 6 45-1599-14 12.5 X 14 mm



45-1650-00
 EYE MAGNET

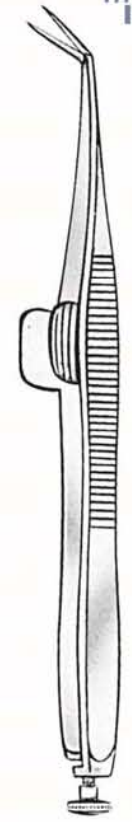

45-0637-11 - 45-0645-11
 11.0 cm
 WECKER

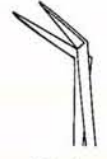

FIG. 1
 45-0637-11

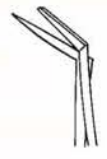

FIG. 2
 45-0641-11

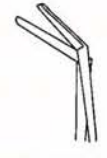

FIG. 3
 45-0645-11



45-1095-03 3 cm
 45-1099-04 4 cm
 BARRAQUER



45-1147-08 8 cm
 CASTROVIEJO



45-1119-07 7 cm
 MULLER



45-1111-07 7 cm
 45-1115-09 9 cm
 GRAEFE

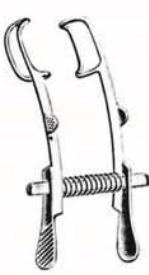

45-1175-05 5 cm
 45-1179-07 7 cm
 MELLINGER

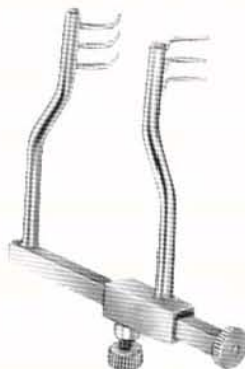

45-1176-05 5 cm
 LOGAN

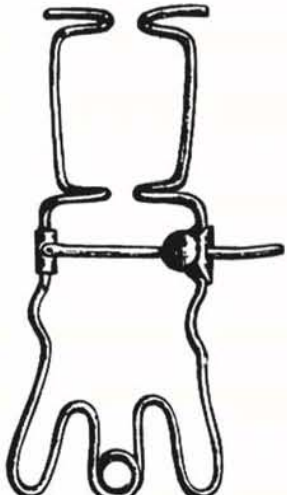

45-1650-14
 14 cm

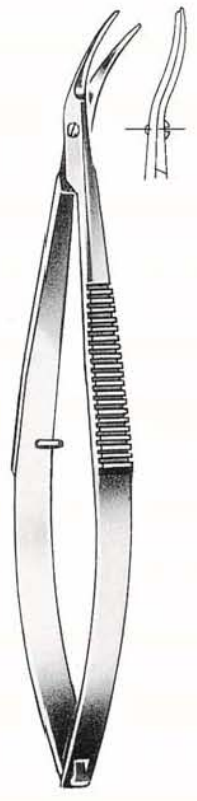

45-0813-11
 11 cm
 CASTROVIEJO



45-0809-11
 11 cm
 CASTROVIEJO

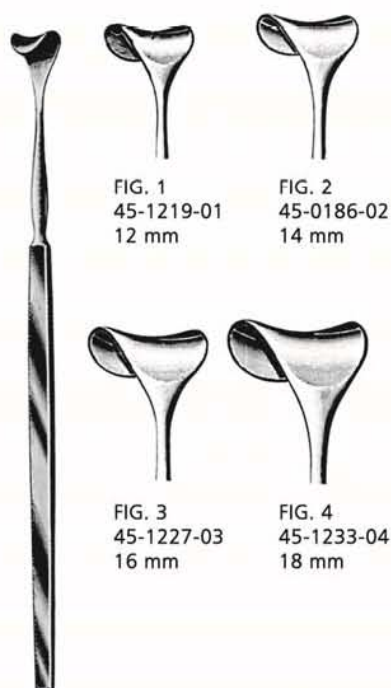

FIG. 1
45-1219-01
12 mm

FIG. 2
45-0186-02
14 mm

FIG. 3
45-1227-03
16 mm

FIG. 4
45-1233-04
18 mm

45-1366-00	FIG. 00	0.7mm
45-1370-00	FIG. 0	0.8mm
45-1374-01	FIG. 1	0.9mm
45-1378-02	FIG. 2	1.1mm
45-1382-03	FIG. 3	1.3mm
45-1386-04	FIG. 4	1.4mm
45-1390-05	FIG. 5	1.5mm
45-1394-06	FIG. 6	1.6mm
45-1398-07	FIG. 7	1.8mm
45-1402-08	FIG. 8	1.9mm

45-1219-01 - 45-1233-04
DESMARRES

BOWMAN

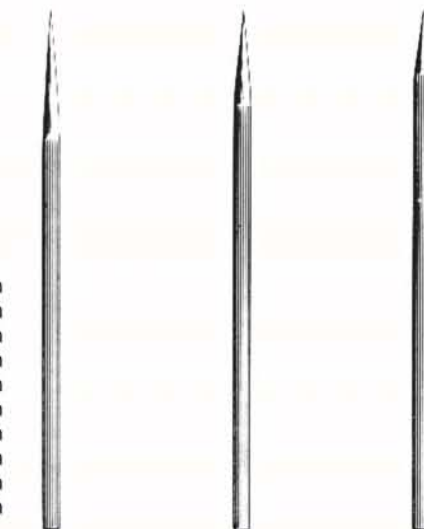
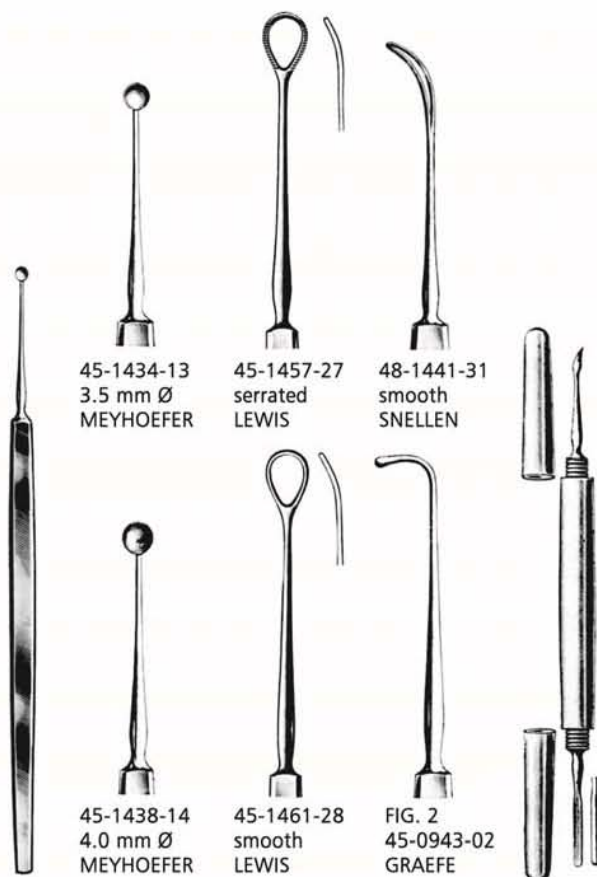

FIG. 1
45.1670.01
10.5 cm
WILDER

FIG. 2
45.1670.02
10.5 cm
WILDER

FIG. 3
45.1670.03
10.5 cm
WILDER



45-1434-13
3.5 mm Ø
MEYHOEFER

45-1457-27
serrated
LEWIS

48-1441-31
smooth
SNELLEN

45-1438-14
4.0 mm Ø
MEYHOEFER

45-1461-28
smooth
LEWIS

FIG. 2
45-0943-02
GRAEFE

45-1034-01



- 45-1035-01
EYE SURGERY SET
Scalpel Handle # 3, 41-0134-03
Adson Tissue Forceps, 12 cm, 1x2 Teeth, 45-0138-12
Barrquer Eye Retarctor, 4 cm, 45-1099-04
Kuhnt Knives, 45-1065-03
Weber Lens Loop, 45-1449-21
Castroviejo Cyclodialysis Spatula, Double, 45-0897-02
Hess Iris Forceps, 7 cm, 45-1776-07
Bishop Harman Iris Forceps, 8.5 cm, 1x2 Teeth, 45-0260-08
Fuchs Capsular Forceps, 7 cm, 45-1778-07
Graefe Fixation Forceps, 11 cm, 45-0378-11
Castroviejo Suture Forceps, Teeth 0.5 mm, 45-0315-10
Tubingen Suture Forceps, 10 cm, 45-0351-10
Desmarres Chalazion Forceps, 9 cm, Fig. 2, 45-0290-09
Castroviejo Iris Scissors, curved, 11 cm, 45-0793-11
Castroviejo Cornea Scissors, left, 10 cm, 45-0813-11
Castroviejo Cornea Scissors, right, 10 cm, 45-0809-11
Baraquer Needle Holder, curved, 11 cm, 45-0871-11
Stevens Scissors, curved, 11 cm, 45-0537-10



BARRAQUER
 45-0871-11
 11 cm



CASTROVIEJO
 45-0793-11
 11 cm



CASTROVIEJO
 45-0897-02



WEBER
 45-1449-21



KUHNT
 45-1065-03



STEVENS - Cvd
 42-0537-10
 10 cm



MICRO ADSON
 45-0138-12
 12 cm



CASRTROVIEJO
 45-0315-10
 10 cm



TUBINGEN
 45.0351.10
 10 cm



FUCHS
 45.1778.07
 7 cm



HESS
 45-1776-07
 7 cm



70-0128-00
MILK SUCKING PREVENTOR-ALUMINUM



70-0130-00



70-0132-04 Ø 4.0 mm
70-0134-04 Ø 4.5 mm
70-0136-05 Ø 5.0 mm



70-0138-09 Ø 2.5 mm
70-0140-09 Ø 3.0 mm
9.0 cm



70-0142-62
62 cm
BIOPSY INSTRUMENTS
DIVIDABLE



70-0144-37
TOOTH FORCEPS
37.0 cm



70-0146-38
TOOTH FORCEPS
38.0 cm



70-0148-30 30.0 cm
70-0150-48 48.5 cm
TOOTH FORCEPS



70-0152-48
TOOTH FORCEPS
48.0 cm



70-0154-48
TOOTH FORCEPS
48.0 cm



70-0156-43
43.0 cm



70-0158-53
53.5 cm



70-0160-65
65.0 cm



70-0162-66
66.0 cm



70-0164-45
45.0 cm



70-0166-52
52.0 cm



70-0178-00
 HOOF KNIFE SET IN CASE
 SET CONTAINS:
 1 Solid Handle
 5 Interchangeable Blades



70-0180-00
 LOOP HOOF KNIFE



70-0182-00
 POCKET HOOF KNIFE



70-0184-18
 18.0 cm
 HOOF KNIFE



70-0186-17
 17.5 cm
 BUSS



70-0188-18
 18.0 cm



70-0190-20
 20.0 cm
 FRICK



70-0192-18
 18.0 cm
 WAMBERG



70-0194-30
 30.0 cm
 HOOF RASP, S-FORM



70-0196-35
 35.0 cm
 HOOF RASP



70-0198-36
 36.0 cm
 HAUPTNER
 HOOF SCAPER



70-0200-33
 33.0 cm
 HOOF SCAPER



70-0202-36
 36.0 cm
 HOOF SCAPER



70-0204-30
30.0 cm
HOOF TESTER



70-0206-39
39.0 cm
HOOF TESTER



70-0208-34
34.0 cm
HOOF TESTER



70-0210-41
41.0 cm
HOOF TESTER



70-0212-30
 30.0 cm
 HOOF CUTTER



70-0214-38
 38.0 cm
 HOOF CUTTER



70-0216-41
 41.0 cm
 FRANK
 HOOF CUTTER

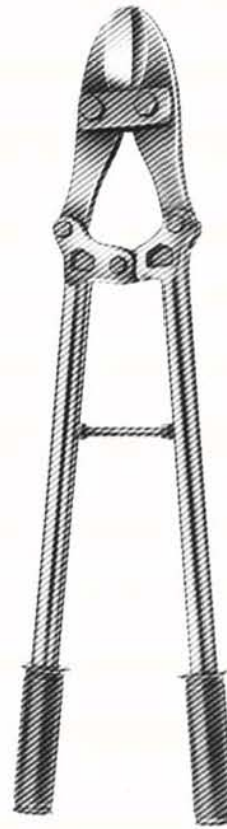

70-0218-60
 60.0 cm
 CLAW CUTTER



70-0220-30
 30.0 cm
 HOOF CUTTER



70-0222-16
 16.0 cm
 CLAW SPATULA



70-0224-26
 26.0 cm
 HOOF CUTTER



70-0226-41
 41.0 cm
 HOOF TRIMMER



70-0228-32
 32.5 cm



70-0230-37
 37.5 cm

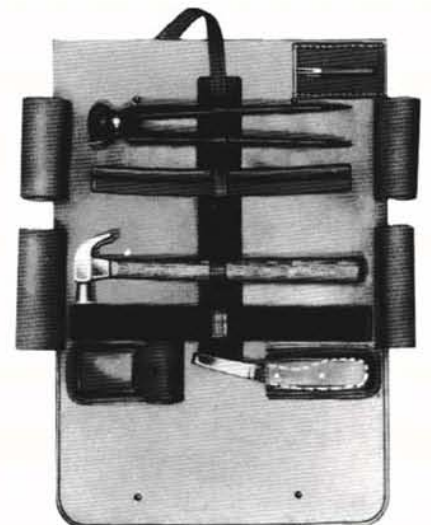

70-0232-00
 FARRIER'S SET



70-0234-00
GUNTHER-HEPKE

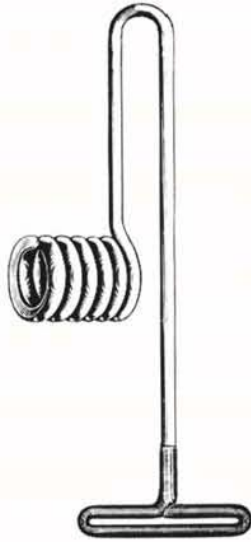

70-0236-00
SCHOUPE



70-0238-00
SCHULZE



70-0240-00
BAYER



70-0242-00
MOUTH SPECULUM



70-0244-00
HOBBLES FOR HORSES
BERLIN MODEL



70-0246-00
MOUTH SPECULUM



70-0250-00



70-0252-00
HAUSSMANN/CLIMAX SPECULUM



70-0248-00
MOUTH SPECULUM



70-0254-00
MOUTH SPECULUM

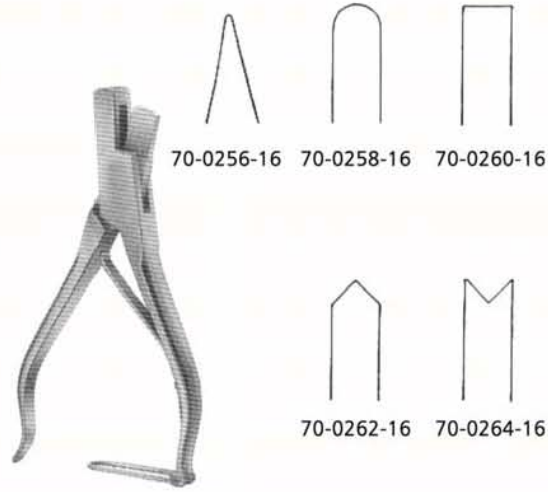

70-0256-16 - 70-0264-16
16.0 cm



70-0266-23
23.0 cm



70-0268-00
TATTOOING FORCEPS
FOR DOGS



70-0270-07
SPARE SET OF NUMBERS
7 mm



70-0272-16
16.5 cm



70-0274-17
17.0 cm
CASTRATION HOOK



70-0276-07
7.0 cm
TOENAIL CLIPPER
FOR CATS



70-0278-16
16.0
TOENAILCLIPPER
HEAVY DUTY



70-0280-12
12.0 cm
TOENAIL TRIMMER



70-0282-13
13.5 cm
TOENAIL CLIPPER



70-0284-10
10.5 cm
SCISSORS



70-0286-26
26.0 cm



70-0288-17
17.0 cm



70-0290-25
25.0 cm



70-0292-00
HAND CLIPPER



70-0294-00
FOR HORSES AND CATTLE



70-0296-17
17.0 cm

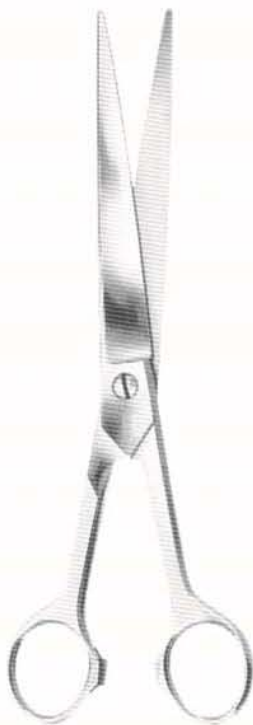

70-0298-20
20.0 cm

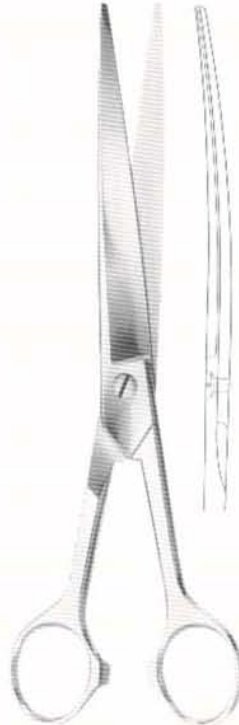

70-0300-20
20.0 cm



70-0302-16
16.0 cm

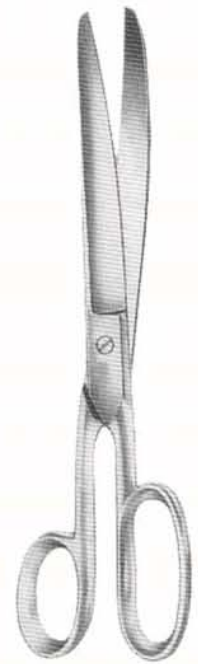

70-0304-20
20.5 cm

INSIDE Ø 36mm
OUTSIDE Ø 39mm



70-0306-00
BALLING GUN
INSIDE Ø 36mm
OUTSIDE Ø 39mm



70-0308-00
SAW WIRE HANDLE, NIELSEN



70-0310-00
SAW WIRE HANDLE THYGESEN



70-0312-00
SAW WIRE HANDLE SQUEEZING TYPE



INSTRUMENTS BOX

	L	W	H
62-0102-00	17 X 7	X 3	cm
62-0106-00	17.5 X 7.5	X 3	cm
62-0110-00	18 X 6	X 3	cm
62-0114-00	18 X 7	X 3	cm
62-0118-00	18 X 9	X 4	cm
62-0122-00	20 X 10	X 4	cm
62-0126-00	10 X 10	X 4	cm

INSTRUMENTS BOX

	L	W	H
62-0194-00	12 X 8	X 3	cm
62-0198-00	20 X 10	X 5	cm
62-0202-00	23 X 15	X 5	cm
62-0206-00	25 X 12	X 5	cm
62-0210-00	25 X 12	X 10	cm
62-0214-00	26 X 15	X 5	cm
62-0218-00	30 X 15	X 5	cm
62-0222-00	30 X 20	X 6	cm
62-0226-00	32 X 8	X 4	cm

STERILIZER WITH HEATER

	L	W	H
62-0230-00	27 X 12	X 6	cm



COTTON/DRESSING JAR WITH LID

62-0346-00	7.5 X 7.5	cm
62-0350-00	10 X 10	cm
62-0354-00	12.5 X 12.5	cm
62-0358-00	15 X 15	cm
62-0362-00	18 X 18	cm
62-0366-00	10 X 12.5	cm
62-0370-00	20 X 20	cm



KIDNEY TRAY

62-0462-00	12	cm
62-0466-00	15	cm
62-0470-00	20	cm
62-0474-00	25	cm
62-0478-00	30	cm



INSTRUMENTS TRAY

	L	W	H
62-0426-00	9.2 X 5.4	X 1	cm
62-0430-00	15 X 10	X 1	cm
62-0434-00	18.5 X 10.5	X 1	cm
62-0438-00	19 X 10	X 1.5	cm
62-0442-00	20 X 10	X 1	cm
62-0446-00	20 X 15	X 1	cm
62-0450-00	25 X 15	X 1	cm
62-0454-00	28 X 19	X 2	cm
62-0458-00	29 X 19	X 1	cm



COTTON/DRESSING JAR WITH LID

62-1460-00	8.5 X 8.5 cm
62-1462-00	15 X 10 cm
62-1464-00	15 X 15 cm
62-1466-00	20 X 20 cm



INSTRUMENTS BOX

	L	W	H
62-1468-00	15.5	6.4	3.2
62-1470-00	16	10	3
62-1472-00	20	10	5
62-1474-00	22	15	5
62-1476-00	26	15	5
62-1478-00	40	10	8
62-1480-00	40	20	8



FORCEPS JAR

62-1482-00	10 X 5 cm
62-1484-00	13 X 5 cm
62-1486-00	16.5 X 5 cm



INSTRUMENTS TRAYS

	L	W	H
62-1488-00	20	17	1.5
62-1490-00	30	24	1.5
62-1492-00	36	24	1.5
62-1494-00	38	20	1.5



KIDNEY TRAYS

62-1496-00	17 cm
62-1498-00	25 cm

INDEX

Percussion Hammers, Scalpel Handles , Resection Knives	1
Operating Scissors	2
Dissecting Scissors	3
Dissecting Scissors , Ligature Scissors	4
Suture Instruments	5
Dissecting Scissors with Tungsten Carbide Inserts	6+7
Bandage Scissors	8
Dressing Forceps, Atrauma Dissecting Forceps	9
Tissue Forceps	10
Splinter forceps , Straw tweezer	11
Artery Forceps	12-14
Towel Forceps , Tissue and Organ holding forceps	15
Retractors , Obstetrical	16
Nitrogen Container forceps	17
Retractors , abdominal Retractors	18
Laryngoscopes, Fiber optic	19, 21
Laryngoscopes, Conventional	20
Tongue holding forceps, Uterine forceps	22
Needle Holders	23
Needle Holders with Tungsten Carbide Inserts	24
Ligature Needle, Cotton Applicators, Probes	25
Bone Curettes, Bone Cutting Forceps	26
Trocars	27, 28
Bone Holding Forceps	29, 30
Chisels, Gouges, Mallets	31
Castration Instruments	32, 33
Restraining Equipments	34, 35
Obstetric Instruments	36, 37
Vaginal Specula, Proctoscopes	38
Rectal Biopsy Specimen forceps suction tubes	39
Dental Instruments	40, 41
Extraction Forceps , English Pattern	42, 43
Root Elevators, Amalgam Carriers	44 -46
Curettes	47, 50
Ear Instruments	51, 52
Eye Instruments	53-56
Teat Instruments	57
Tooth Forceps For Large Animals	58, 59
Tooth Rasps for Horses	60
Hoof and Claw Instruments	61-64
Restraining	65
Ear Marking and Tagging	66
Dogs and Cats Instruments	67
Hand Clippers, Hair Scissors	69
Balling Gun, Saw Wire Handles	70
Instruments , Boxes, Sterilizing/Dressing Drum, Trays	71, 72



medisana
International

Medisana International

P.O. Box 1357

Sialkot – Pakistan

Tel: 0092 52 4264571

Fax: 0092 52 4264026

Email: info@medisanaintl.com