

PLASTIC SURGERY
Maxillo Facial Surgery
Liposuction



medisana
International



Delicate Scissors	02
Dissecting Scissors	03 - 05
Abdominal Scissors	06
Operating Scissors	07
Dissecting Scissors	08 - 10
Artery Forceps, Towel Clamps	11
Needle Holders	12 - 14
Micro Scissors	15 - 18
Micro Needle Holders	19 - 21
Dressing Forceps, Tissue Forceps	22 - 23
Hooks & Retractors	24 - 25
Retractors	26 - 28
Nasal Instruments	29, 31
Skin Graft Knives	30
Chisels, Hammers	32
Nasal Speculam	33 - 35
Breast Retractors	36 - 39
Liposuction Instruments	40 - 45

M.A.Arain & Brother (Pvt) Ltd. Manufacture **SuperCut Scissors** highest quality stainless steel. These scissors have a specially designed razor-sharp upper blade edge that cuts effortlessly through tissue. The lower blade has micro-fine serrations to hold and prevent tissue slippage

Identification



Tungsten Carbide Scissor



Supercut Scissor
One Blade Razor Sharp Edge
One Blade Micro-fine Serration



Supercut Plus T/c Scissor
Tungsten Carbide Blades
One Blade Micro-fine Serration



IRIS

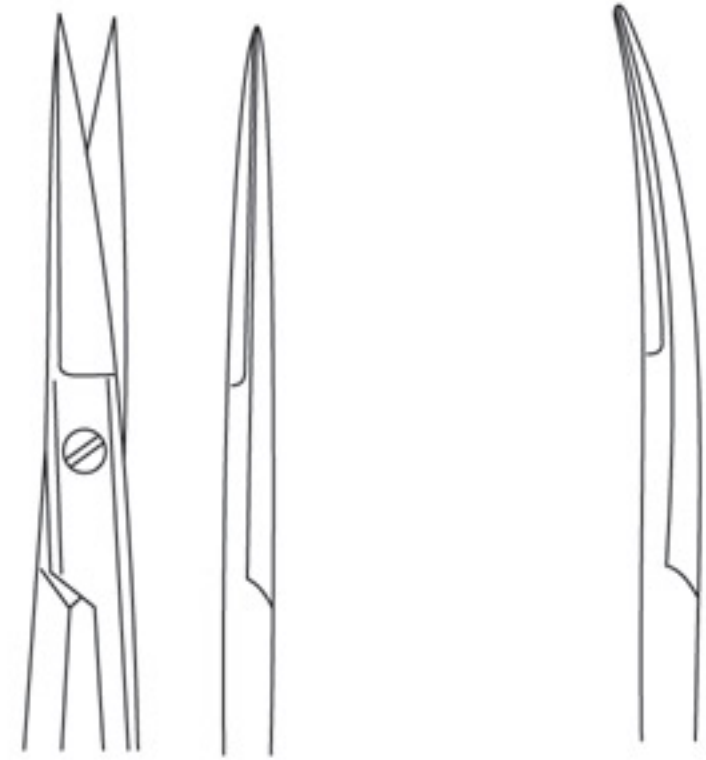

Straight

Curved

Straight	TC	SUPERCUT	SUPERCUT PLUS TC
11.5 cm/4½"	42.1208.11	42.1342.11	42.1501.11

Curved	TC	SUPERCUT	SUPERCUT PLUS TC
11.5 cm/4½"	42.1213.11	42.1345.11	42.1502.11



IRIS
RIBBON HANDLE

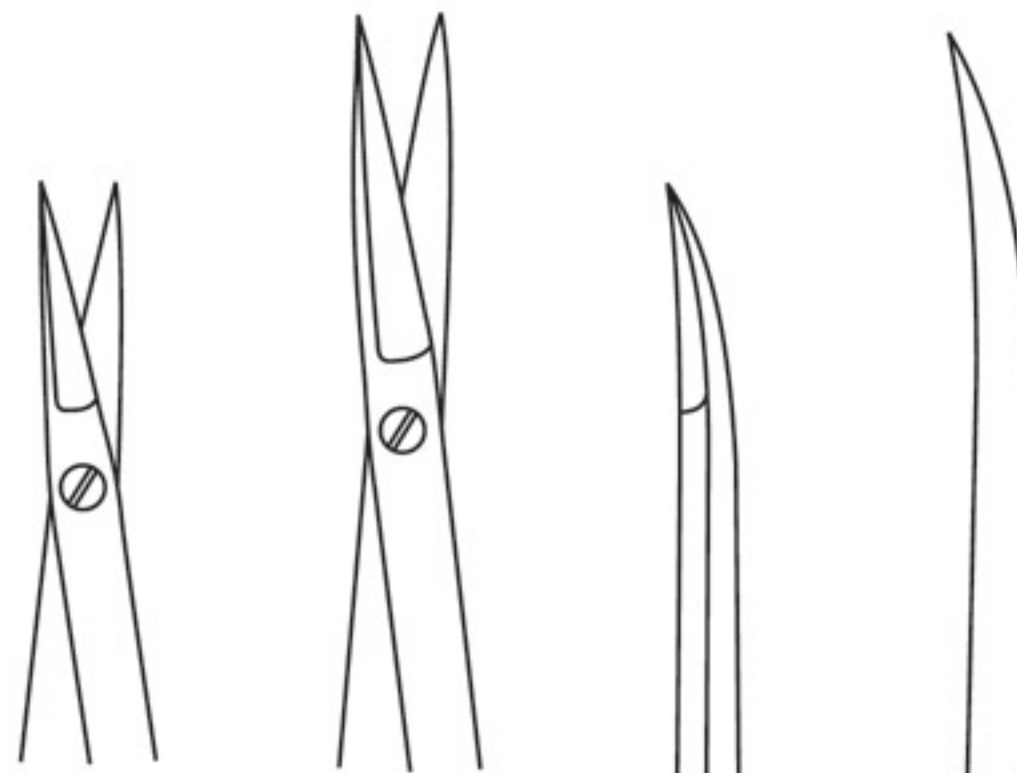

Straight

Curved

Straight	TC	SUPERCUT	SUPERCUT PLUS TC
9.5 cm/ 3¾"	42.1215.09	42.1362.09	42.1505.09
10.5 cm/ 4¼"	42.1217.10	42.1364.10	42.1506.10

Curved	TC	SUPERCUT	SUPERCUT PLUS TC
9.5 cm/ 3¾"	42.1220.09	42.1366.09	42.1508.09
10.5 cm/ 4¼"	42.1222.10	42.1367.10	42.1509.10



STEVENS



Straight	TC	SUPERCUT	SUPERCUT PLUS TC
11.5 cm/4½"	42.1225.11	42.1369.11	42.1512.11
13 cm/5½"	42.1226.13	42.1370.13	42.1513.13

Curved	TC	SUPERCUT	SUPERCUT PLUS TC
11.5 cm/4½"	42.1229.11	42.1374.11	42.1517.11
13 cm/5½"	42.1230.13	42.1375.13	42.1518.11



MINI-METZENBAUM

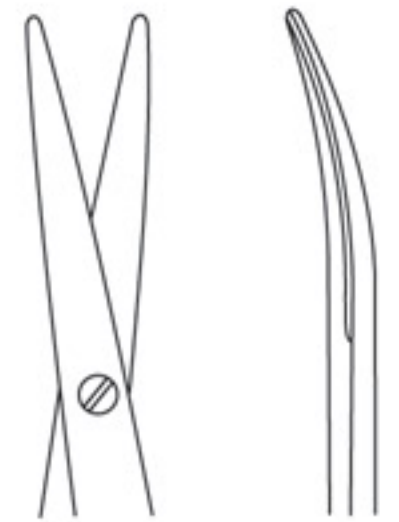

Straight	TC	SUPERCUT	SUPERCUT PLUS TC
9 cm/3½"	42.1232.09	42.1378.09	42.1521.09

Curved	TC	SUPERCUT	SUPERCUT PLUS TC
9 cm/3½"	42.1234.09	42.1380.09	42.1525.09



BABY-METZENBAUM

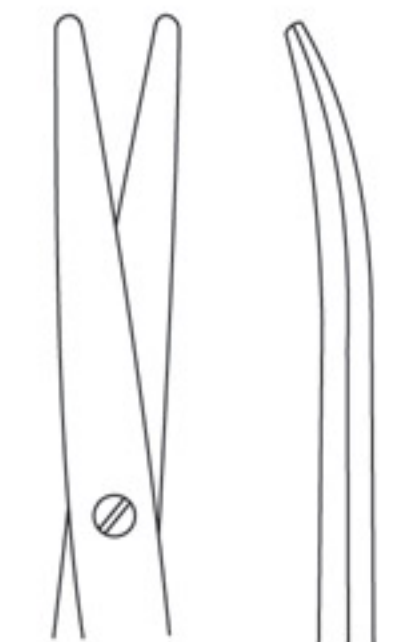

Straight	TC	SUPERCUT	SUPERCUT PLUS TC
11.5 cm/4½"	42.1236.11	42.1385.11	42.1528.11

Curved	TC	SUPERCUT	SUPERCUT PLUS TC
11.5 cm/4½"	42.1238.11	42.1387.11	42.1529.11



METZENBAUM

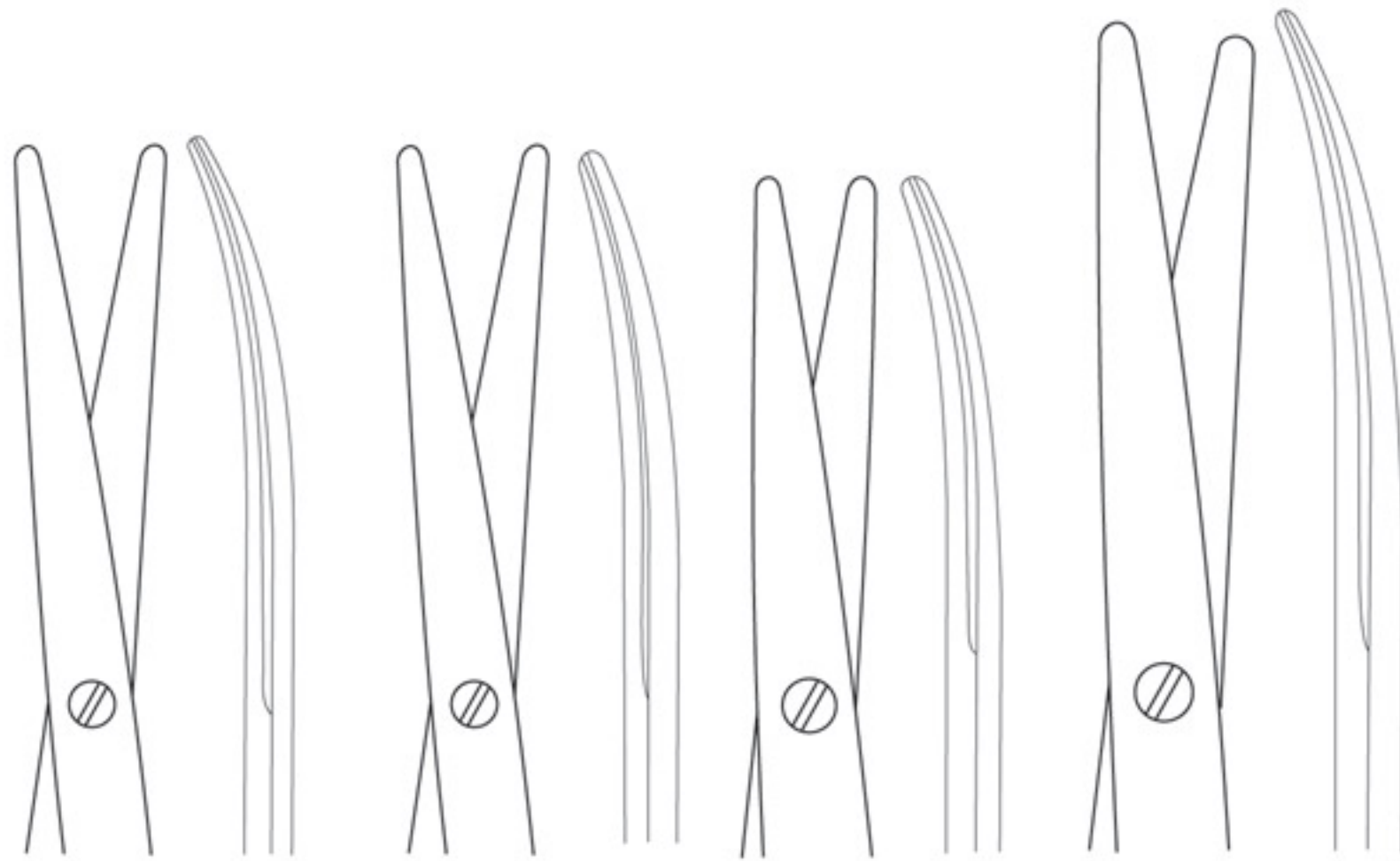

Straight	TC	SUPERCUT	SUPERCUT PLUS TC
14 cm/5½"	42.1045.14	42.1291.14	42.1532.14
15 cm/6"	42.1046.15	42.1294.15	42.1534.15
18 cm/7"	42.1048.18	42.1298.18	42.1536.18
20 cm/8"	42.1052.20	42.1202.20	42.1538.20

Curved	TC	SUPERCUT	SUPERCUT PLUS TC
14 cm/5½"	42.1070.14	42.1312.14	42.1542.14
15 cm/6"	42.1073.15	42.1313.15	42.1545.15
18 cm/7"	42.1071.18	42.1317.18	42.1548.18
20 cm/8"	42.1075.20	42.1321.20	42.1551.20



METZENBAUM-SLIM

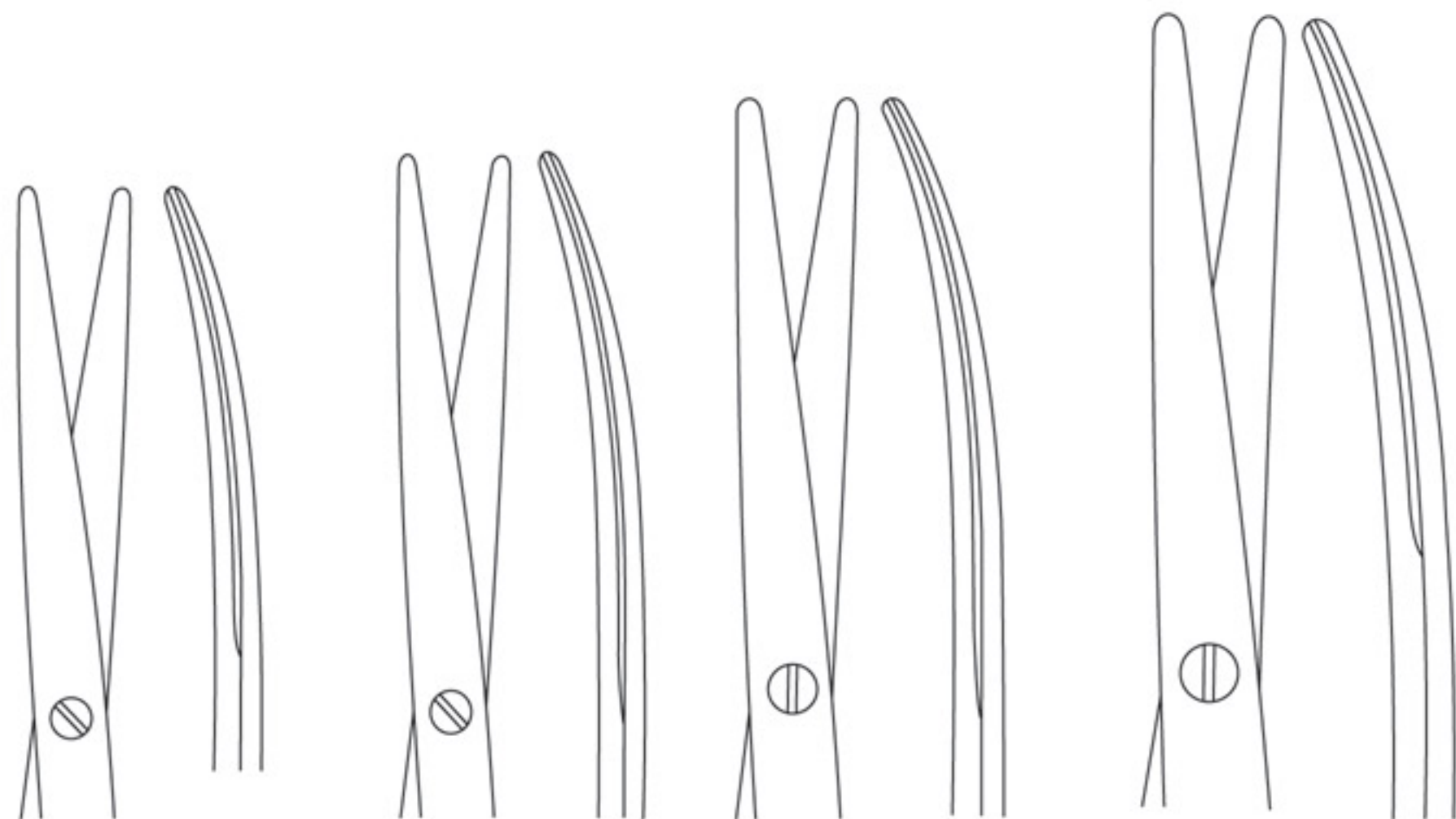

Straight	TC	SUPERCUT	SUPERCUT PLUS TC
14 cm/5½"	42.1240.14	42.1385.14	42.1555.14
15 cm/6"	42.1241.15	42.1387.15	42.1558.15
18 cm/7"	42.1242.18	42.1390.18	42.1559.18
20 cm/8"	42.1243.20	42.1392.20	42.1562.20

Curved	TC	SUPERCUT	SUPERCUT PLUS TC
14 cm/5½"	42.1247.14	42.1395.14	42.1565.14
15 cm/6"	42.1248.15	42.1397.15	42.1567.15
18 cm/7"	42.1249.18	42.1399.18	42.1569.18
20 cm/8"	42.1250.20	42.1403.20	42.1572.20



MAYO

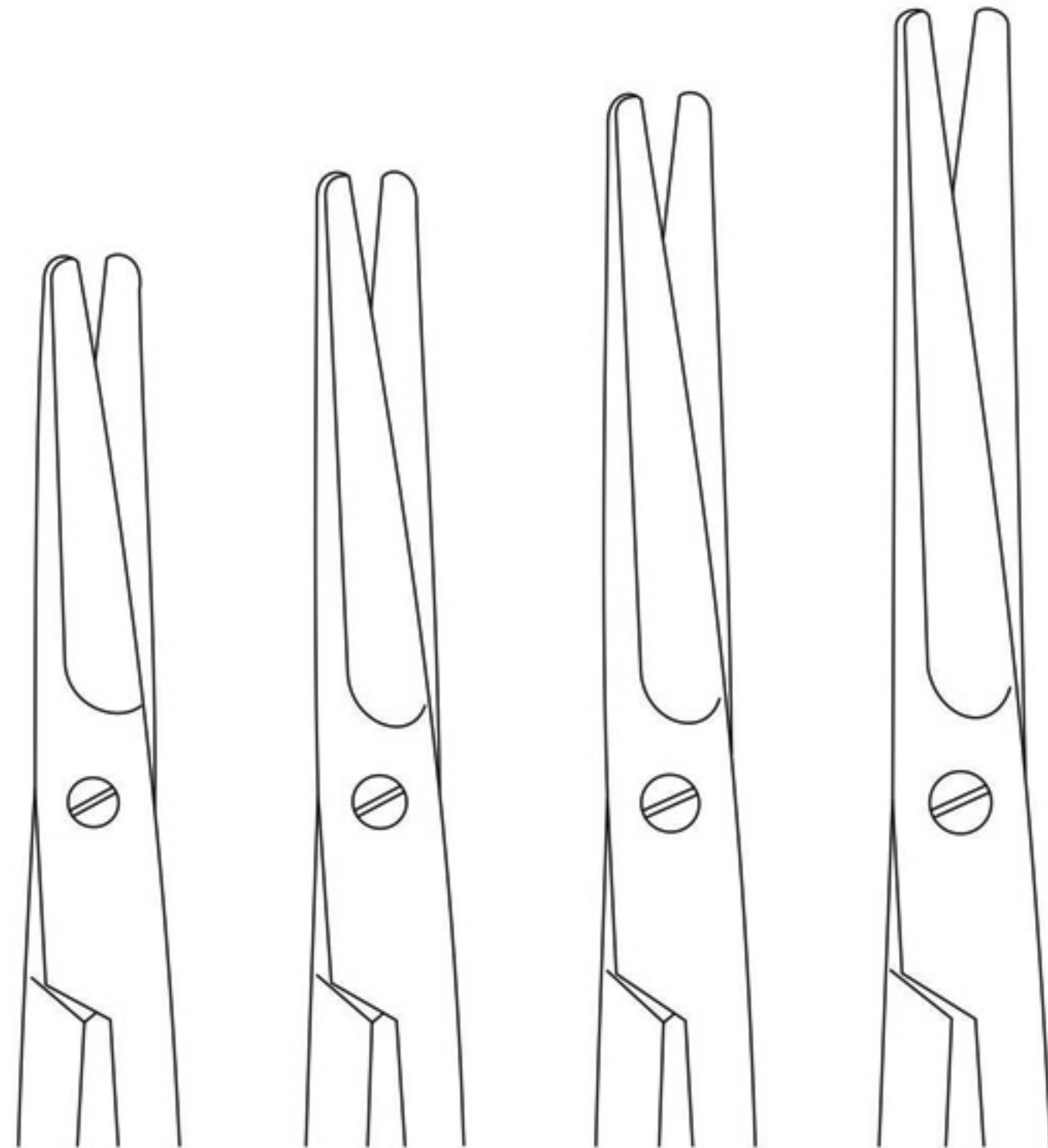

Straight	TC	SUPERCUT	SUPERCUT PLUS TC
14 cm/5½"	42.1016.14	42.1245.14	42.1575.14
15.5 cm/6⅛"	42.1017.15	42.1246.15	42.1578.15
17 cm/6¾"	42.1020.17	42.1247.17	42.1581.17
23 cm/9"	42.1021.23	42.1248.23	42.1583.23

Curved	TC	SUPERCUT	SUPERCUT PLUS TC
14 cm/5½"	42.1023.14	42.1250.14	42.1588.14
15.5 cm/6⅛"	42.1024.15	42.1251.15	42.1591.15
17 cm/6¾"	42.1027.17	42.1252.17	42.1594.17
23 cm/9"	42.1029.23	42.1253.23	42.1597.18



MAYO-STILLE

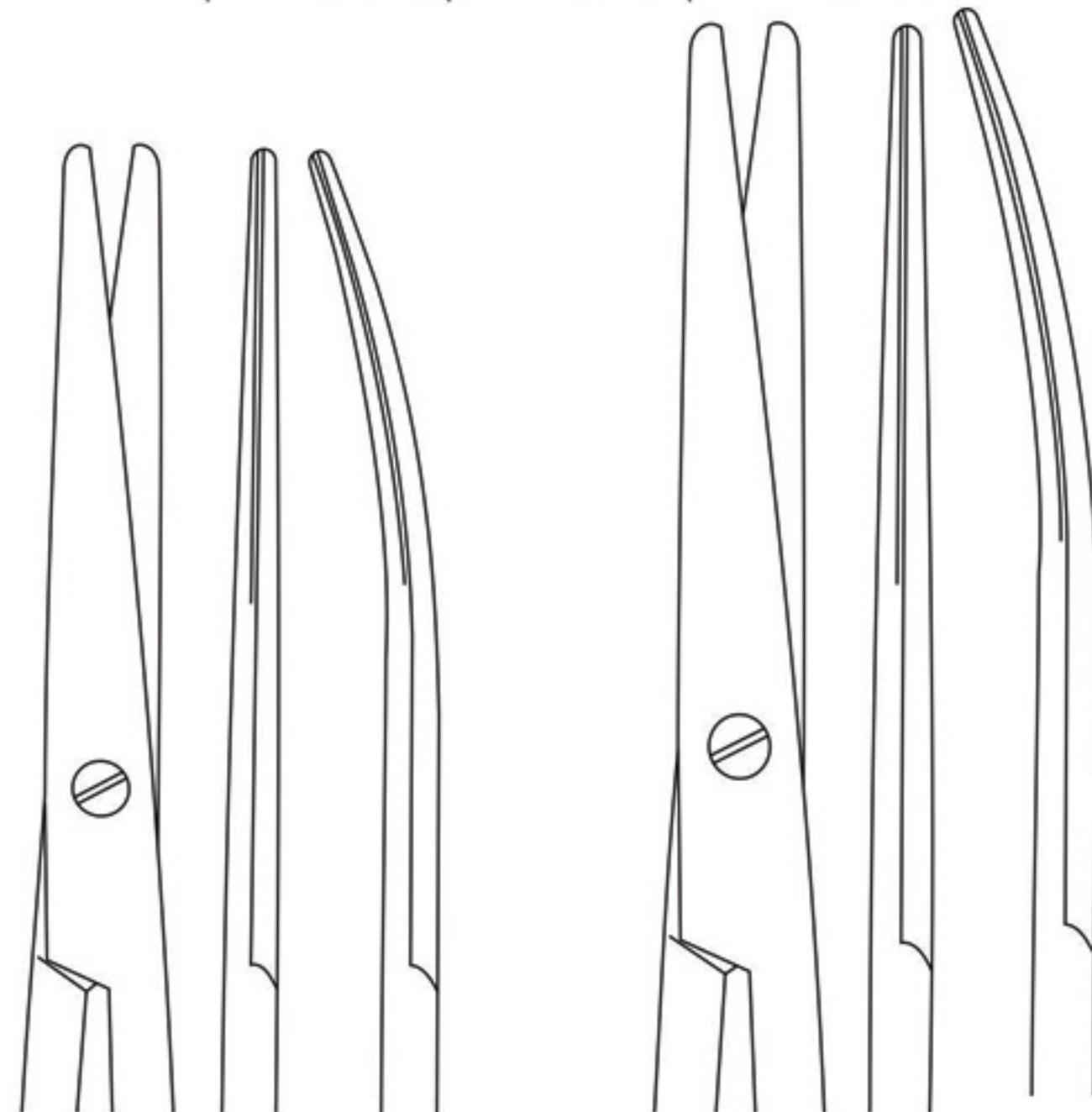

Straight	TC	SUPERCUT	SUPERCUT PLUS TC
15 cm/6"	42.1270.15	42.1251.15	42.1601.15
17 cm/6¾"	42.1272.17	42.1258.17	42.1603.17

Curved	TC	SUPERCUT	SUPERCUT PLUS TC
15 cm/6"	42.1275.15	42.1261.15	42.1605.15
17 cm/6¾"	42.1278.17	42.1265.17	42.1607.17



DOYEN



Straight	TC	SUPERCUT	SUPERCUT PLUS TC
18 cm	42.1280.18	42.1407.18	42.1601.18

Curved	TC	SUPERCUT	SUPERCUT PLUS TC
18 cm	42.1285.18	42.1409.18	42.1604.18



SIMS



Straight	TC	SUPERCUT	SUPERCUT PLUS TC
20 cm	42.1287.20	42.1412.20	42.1608.20
23 cm	42.1289.23	42.1415.23	42.1611.23

Curved	TC	SUPERCUT	SUPERCUT PLUS TC
20 cm	42.1039.20	42.1417.20	42.1615.20
23 cm	42.1043.23	42.1419.23	42.1619.23



SIEBOLD

	TC	SUPERCUT	SUPERCUT PLUS TC
24.5 cm/9¾"	42.1290.24	42.1423.24	42.1623.24



	TC	SUPERCUT	SUPERCUT PLUS TC
25 cm/10"	42.1294.25	42.1426.25	42.1627.25



RESANO



RAGNELL (KILNER)



	TC	SUPERCUT	SUPERCUT PLUS TC
13 cm/5 1/8"	42.1802.13	42.1429.13	42.1630.13
15 cm/6"	42.1805.15	42.1281.15	42.1633.15
18 cm/7 1/8"	42.1808.18	42.1285.18	42.1635.18



PECK-JOSEPH

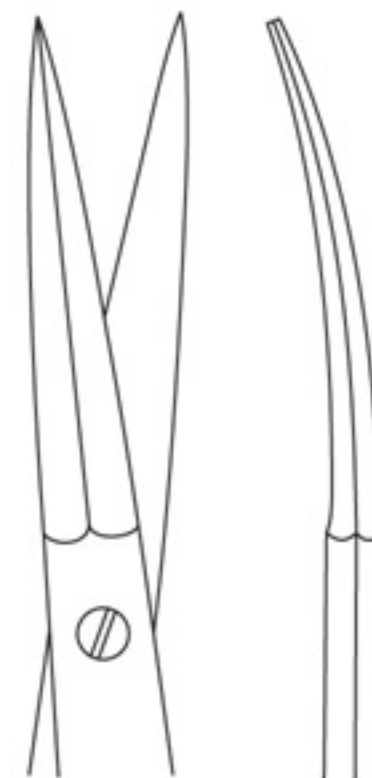

Straight	TC	SUPERCUT	SUPERCUT PLUS TC
14 cm/5 1/2"	42.1810.14	42.1431.14	42.1637.14

Curved	TC	SUPERCUT	SUPERCUT PLUS TC
14 cm/5 1/2"	42.1813.14	42.1435.14	42.1639.14



METZENBAUM-FREEMAN

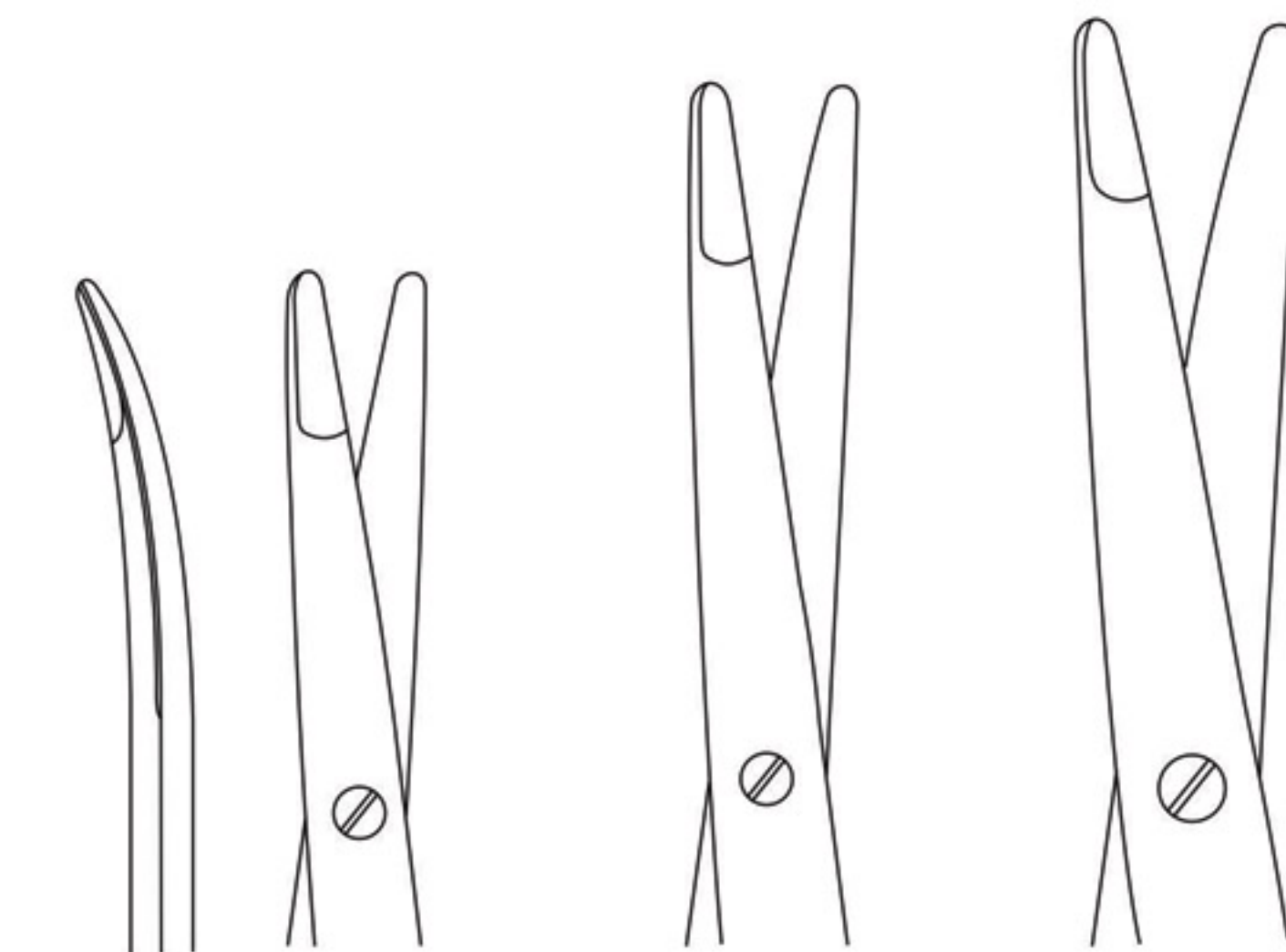

	TC	SUPERCUT	SUPERCUT PLUS TC
18 cm/7 $\frac{1}{8}$ "	42.1819.18	42.1437.18	42.1643.18
20 cm/8"	42.1821.20	42.1440.20	42.1647.20
23 cm/9"	42.1823.23	42.1443.23	42.1650.23

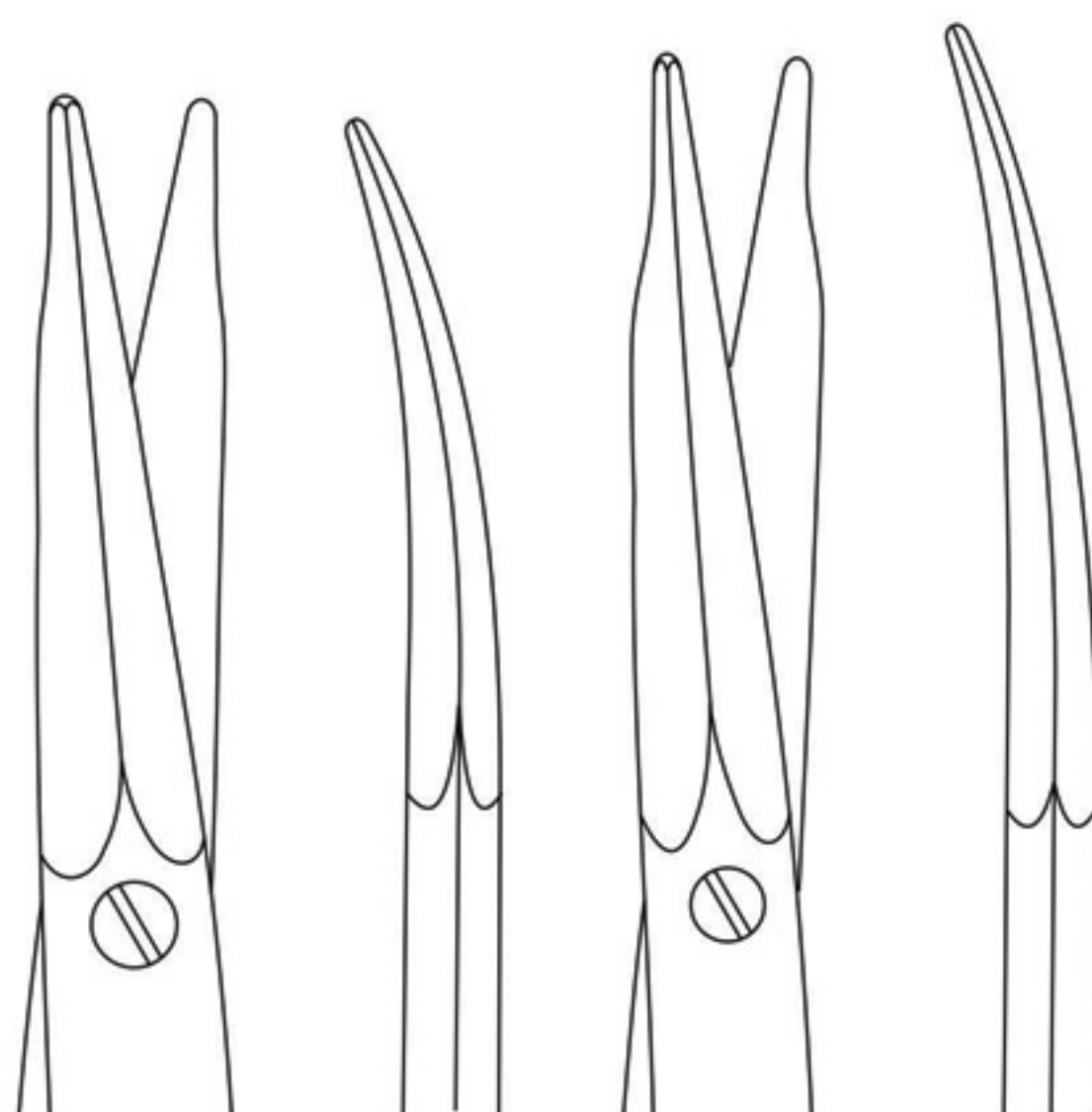

Straight	TC	SUPERCUT	SUPERCUT PLUS TC
16.5 cm/6 $\frac{1}{2}$ "	42.1825.16	42.1447.16	42.1655.16
20.5 cm/8"	42.1827.20	42.1451.20	42.1657.20

Curved	TC	SUPERCUT	SUPERCUT PLUS TC
16.5 cm/6 $\frac{1}{2}$ "	42.1830.16	42.1455.16	42.1660.16
20.5 cm/8"	42.1833.20	42.1457.20	42.1663.20



FANOUS



GORNEY
FACELIFT

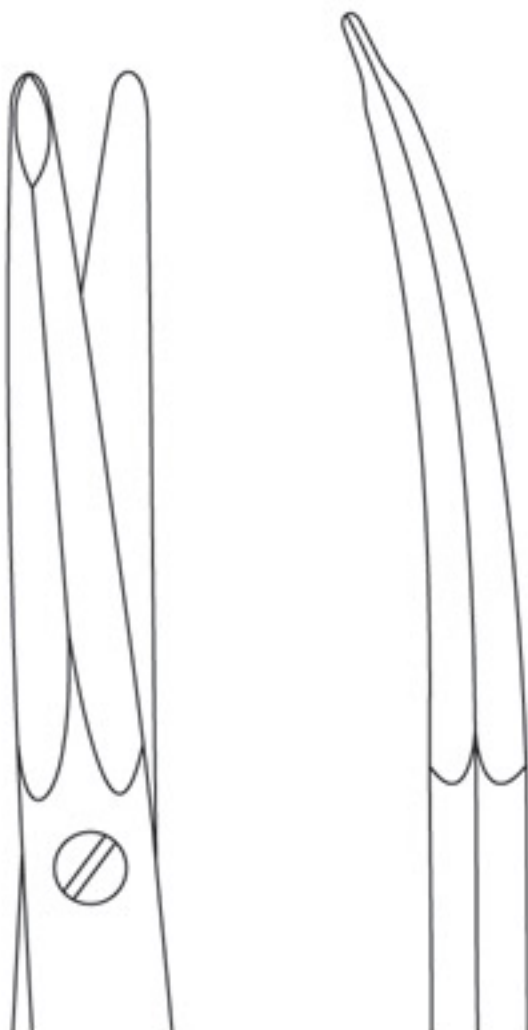

	TC	SUPERCUT	SUPERCUT PLUS TC
17 cm/6¾"	42.1835.17	42.1460.17	42.1665.17

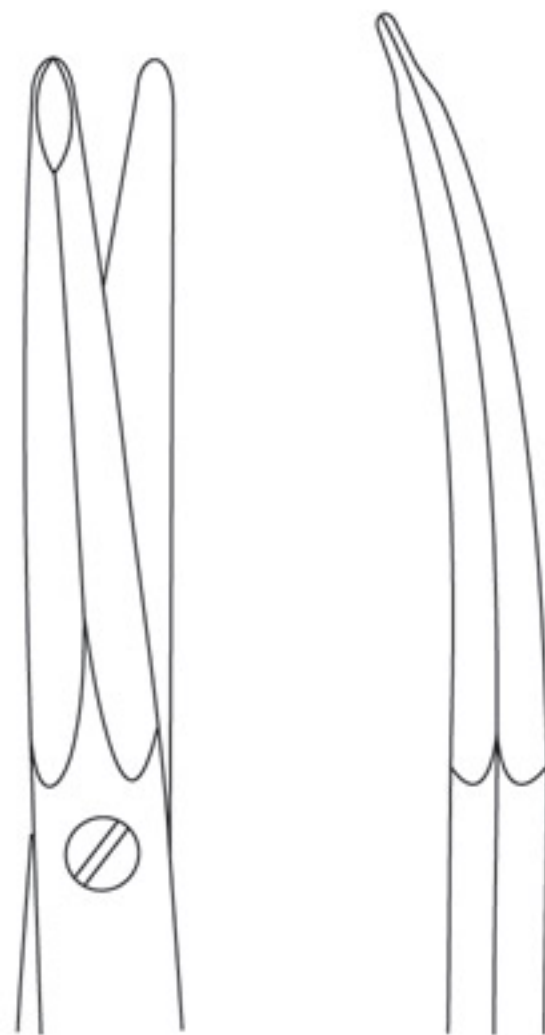

	TC	SUPERCUT	SUPERCUT PLUS TC
17 cm/6¾"	42.1855.17	42.1875.17	42.1680.17



GORNEY-FREEMAN
FACELIFT



43.0377.10



43.0374.10



(BABY MOSQUITO)
43.0825.10 - 43.0377.10
10 cm



43.0497.12



43.0494.12



HALSTEAD MOSQUITO
43.0494.12 - 43.0497.12
12.5 cm / 5"

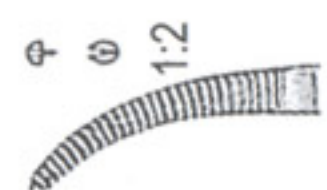

43.0505.12



43.0502.12



KOCHER MOSQUITO
43.0502.12 - 43.505.12
12.5 cm / 5"

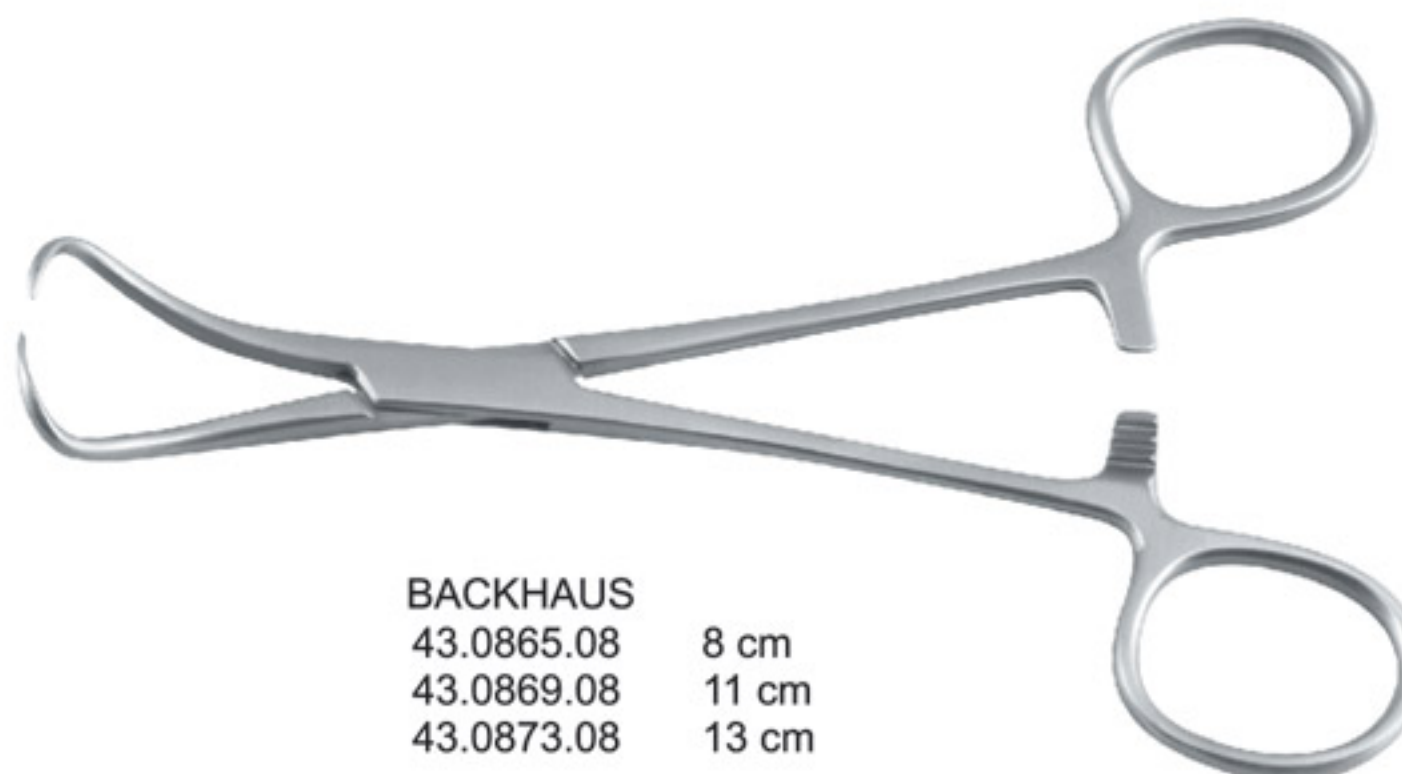

BACKHAUS
43.0865.08 8 cm
43.0869.08 11 cm
43.0873.08 13 cm



HALSEY
46.0288.13
13 cm

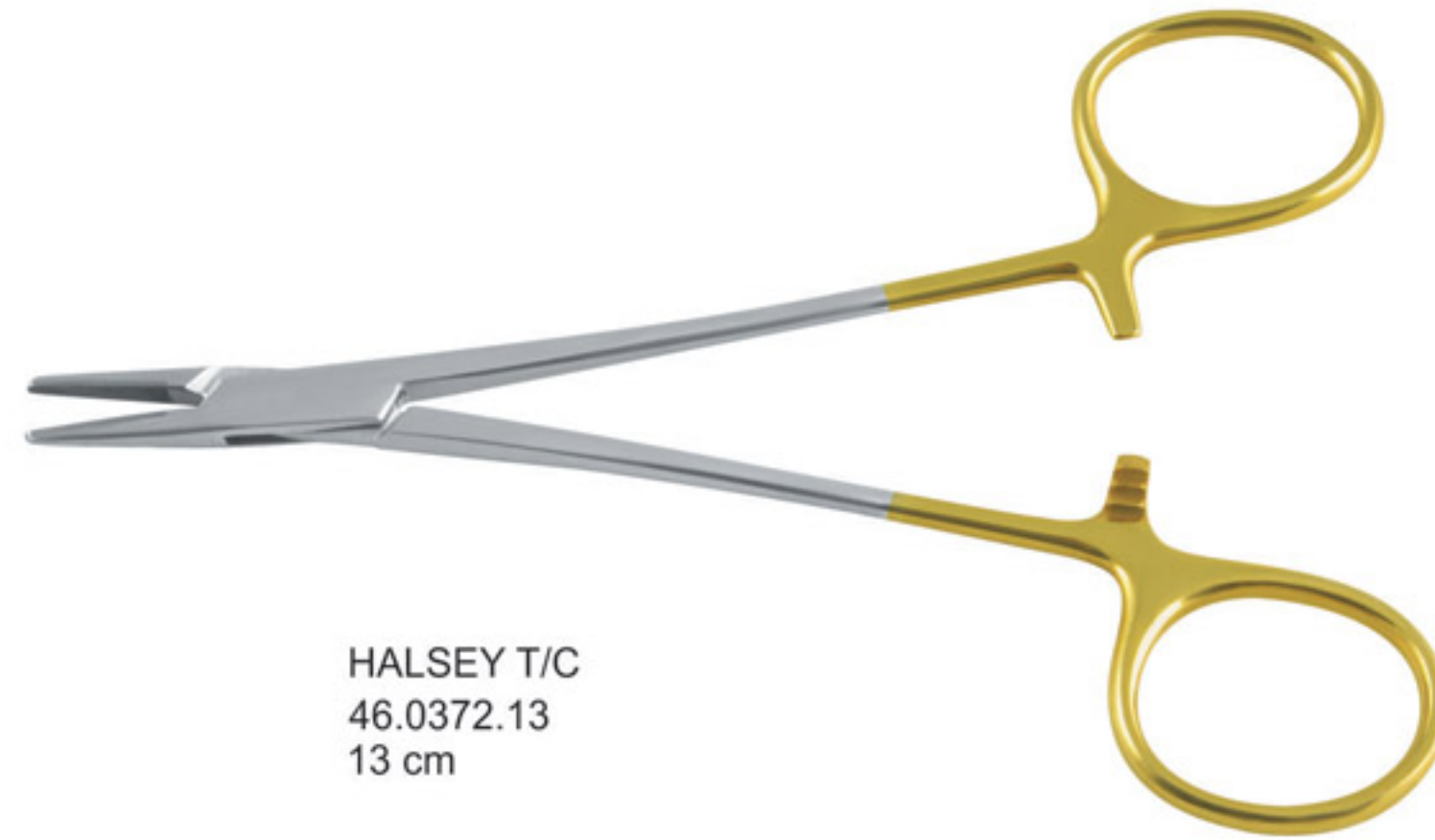

HALSEY T/C
46.0372.13
13 cm

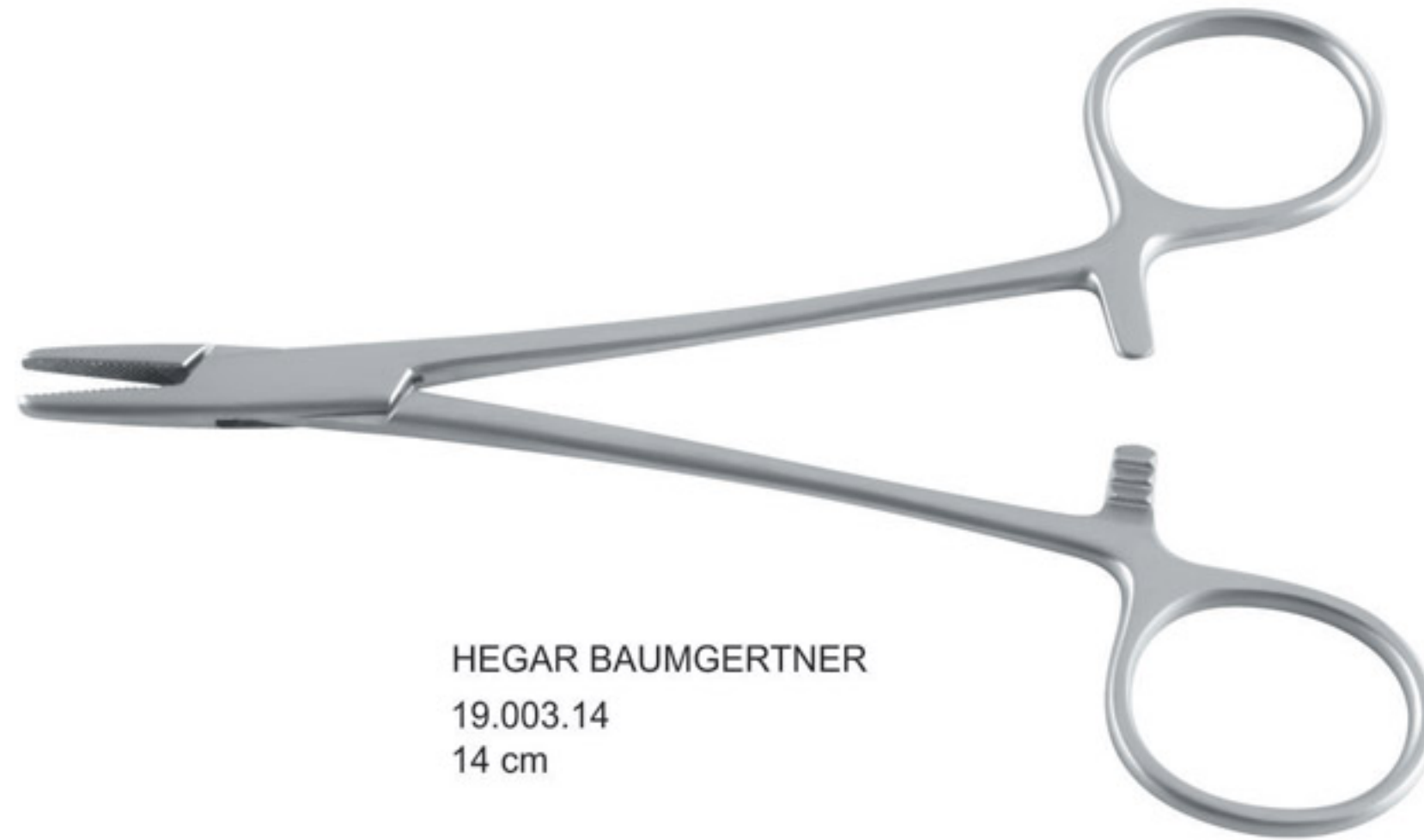

HEGAR BAUMGERTNER
19.003.14
14 cm



DERF
46.0248.12
12 cm



DERF TC
46.0368.12
12 cm



Smooth



WEBSTER, T/C
46.0380.13
12.5 cm



KILNER
46.0280.13
13.5 cm



KILNER, T/C
46.0364.13
13.5 cm



46.0228.18
18 cm



46.0224.16
16 cm

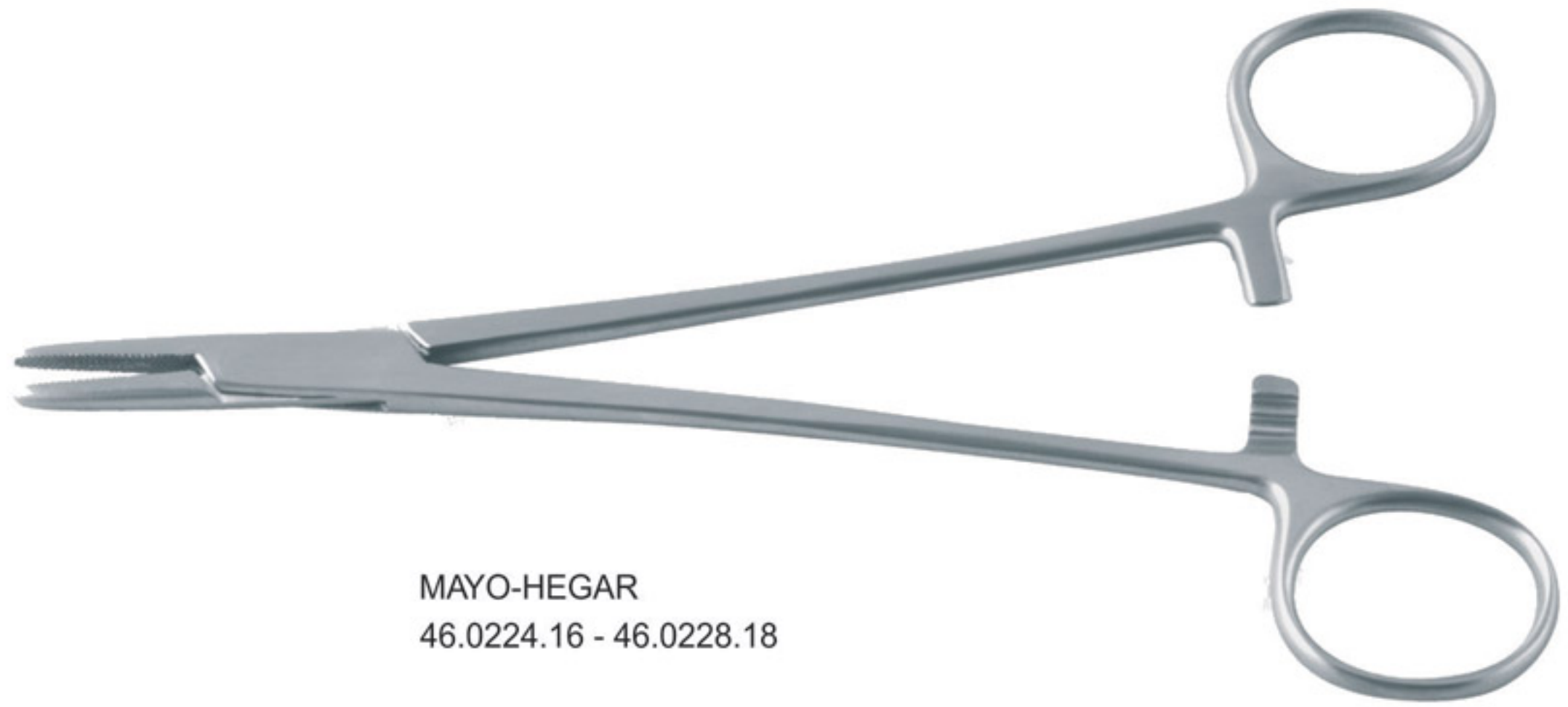

MAYO-HEGAR
46.0224.16 - 46.0228.18



46.0584.18
18 cm



46.0580.16
16 cm

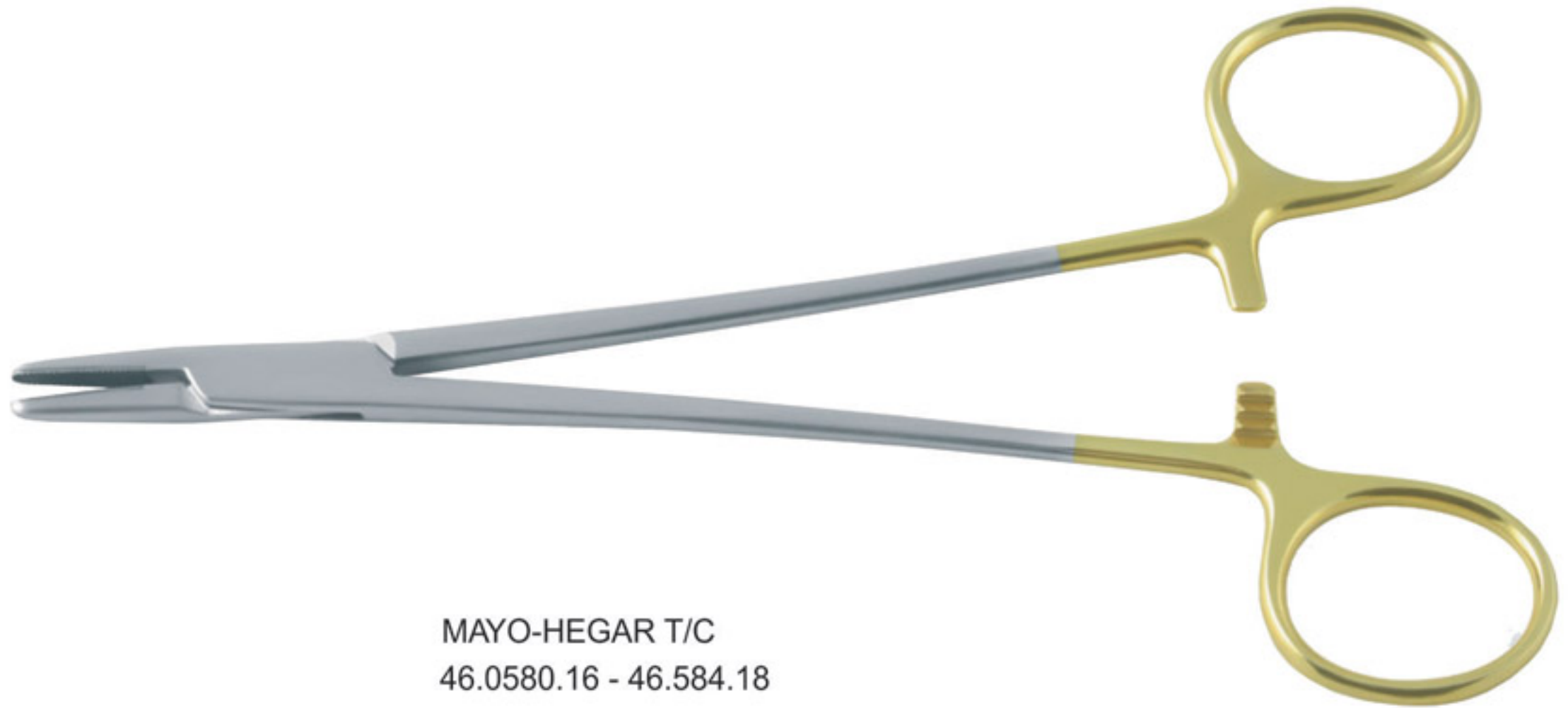

MAYO-HEGAR T/C
46.0580.16 - 46.584.18



CRILE WOOD, T/C
46.602.15
15 cm



BARRAQUER
 45.0649.05 5mm
 45.0653.07 7mm
 45.0657.10 10mm

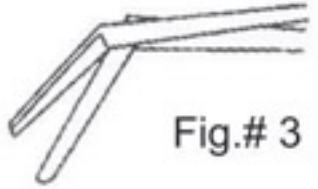

Fig.# 3

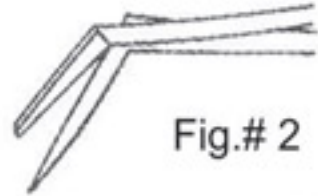

Fig.# 2

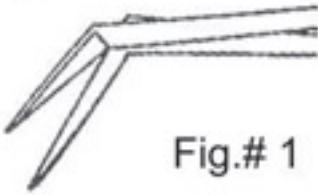

Fig.# 1



WECKER
 45.0637.11 Fig.# 1
 45.0641.11 Fig.# 2
 45.0645.11 Fig.# 3
 11 cm



WESTCOTT
 45.0457.12
 12 cm

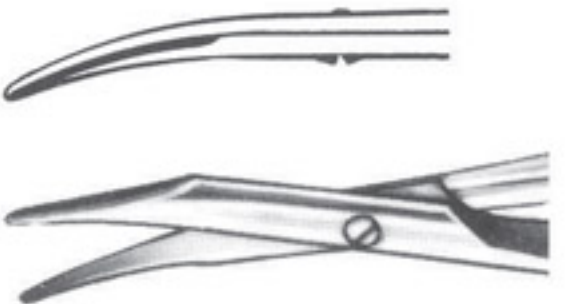

WESTCOTT
 45.1894.11
 11 cm,CVD



45.0.769.08



VANNAS
 45.0748.08
 8.0 cm



45.0751.08



45.0748.08

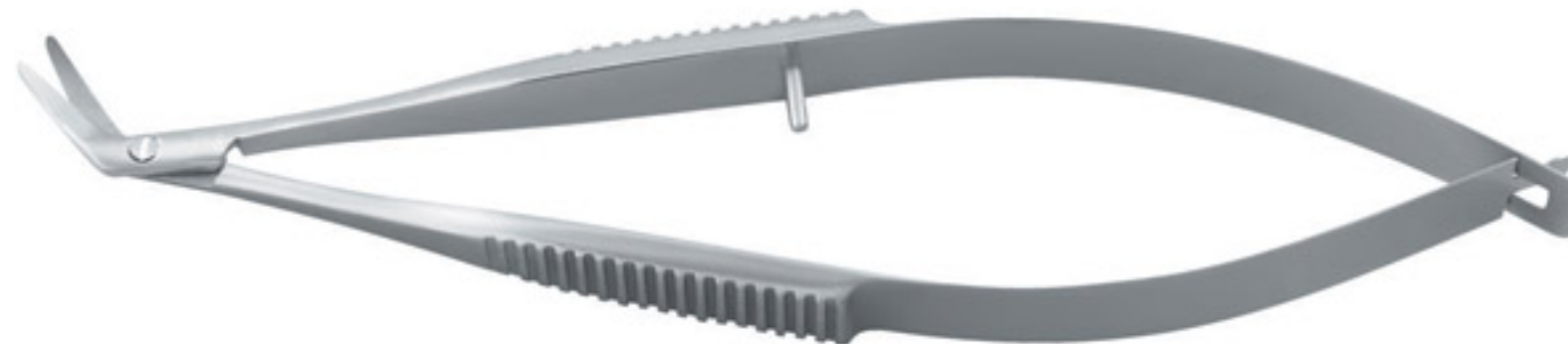

KATZIN
 45.1926.10
 10 cm

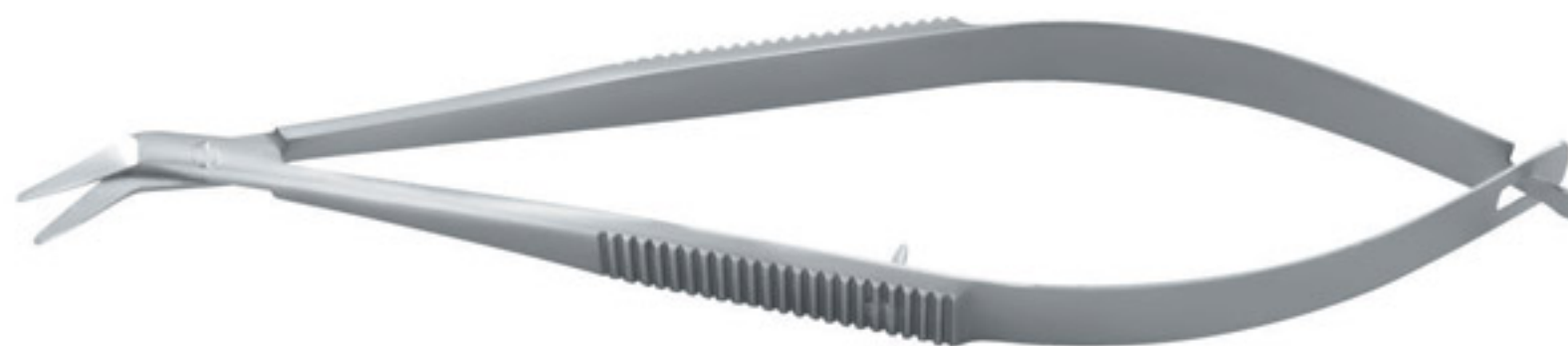
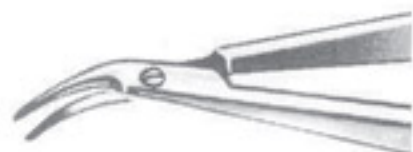

KATZIN
 45.1930.10
 10 cm

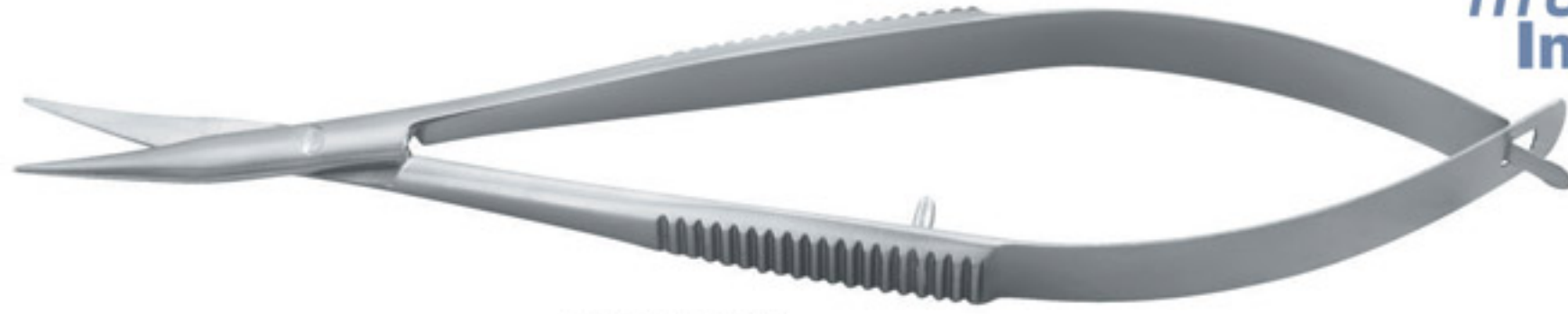
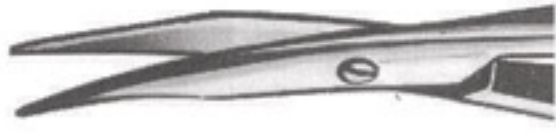

WEATCOTT
45.1906.11
11 cm

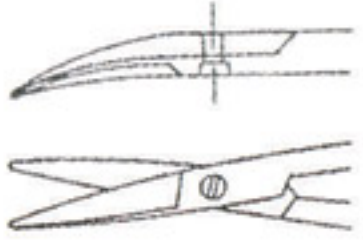

45.0699.18

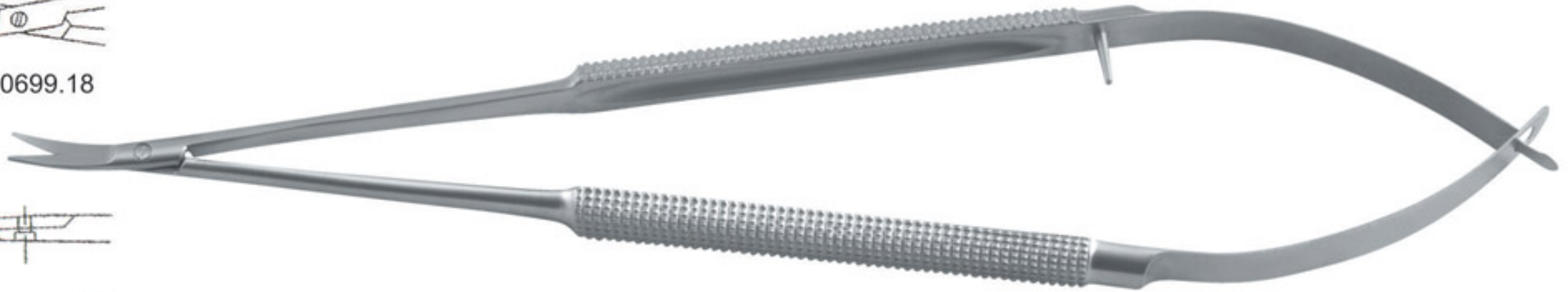

45.0696.18 - 45.0699.18
18 cm

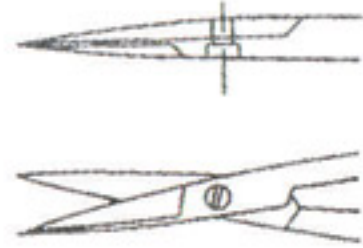

45.0696.18

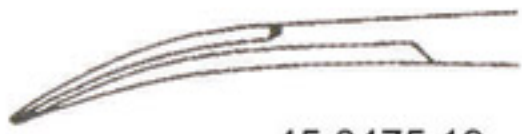

45.0475.19



45.0472.19 - 45.0475.19
19 cm



45.0472.19

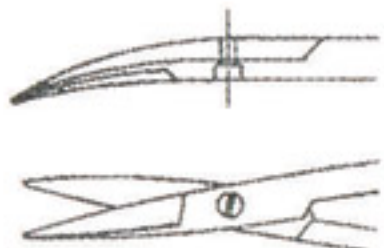

45.0686.15



MICRO SCISSOR
45.0686.15 - 45.0687.15
15 cm

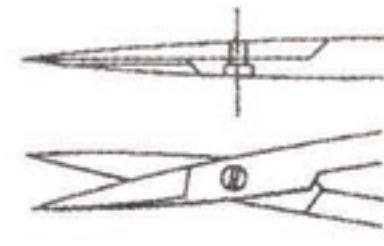

45.0687.15



45.0610.12

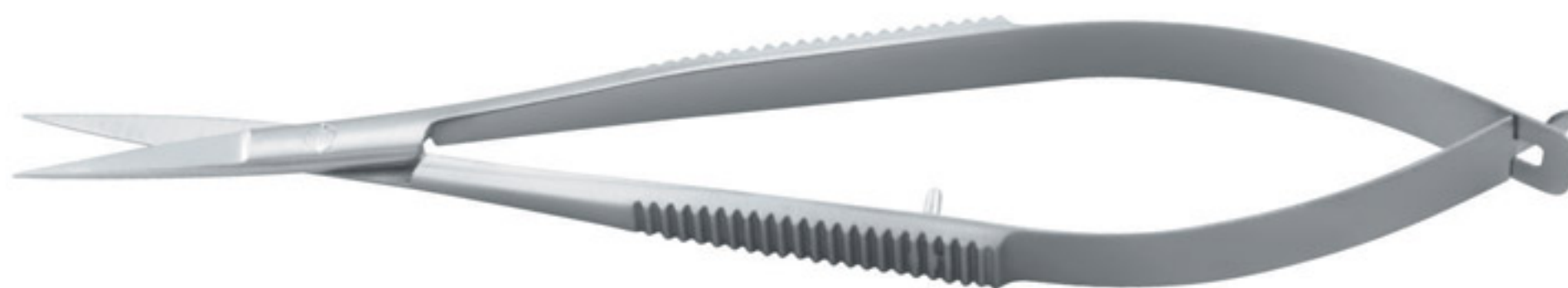

NOYES
45.0602.12 - 45.610.12
12 cm

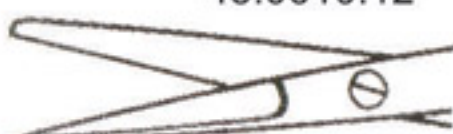

45.0606.12



45.0602.12

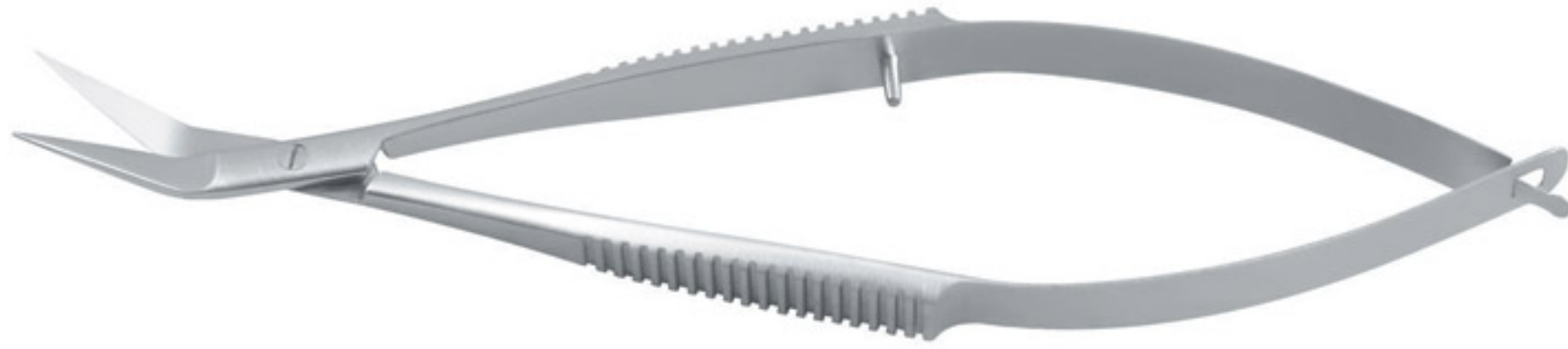

NOYES
45.0625.12
12 cm



KATZIN-BARRAQUER
45.0681.10
10 cm



KATZIN-BARRAQUER
45.0677.10
10 cm



45.1919.10
10 cm



CATROVIEJO
45.0793.10
10 cm



45.1902.10
10 cm



TROUTMAN
45.1922.10
10 cm



TROUTMAN
45.1914.10
10 cm

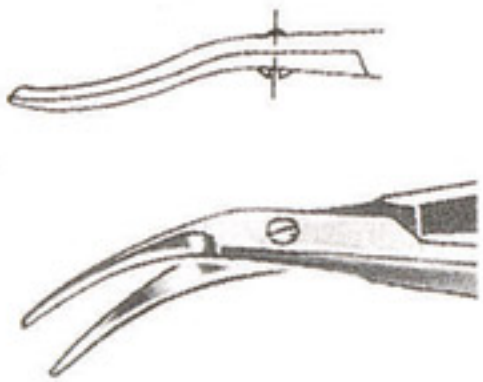

CASTROVIEJO
45.0809.11
11 cm



CASTROVIEJO
45.1910.00



45.1918.15
15 cm



45.0491.16

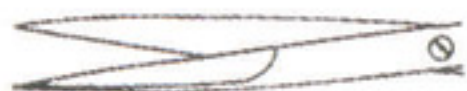

45.0491.16



45.0478.16 - 45.491.16
16 cm



46.0811.09
46.0811.09



46.0808.09
46.0808.09



CASTROVIEJO
46.0808.09 - 46.0811.09
9 cm

46.1808.09 - 46.1811.09 (Titanium)
9 cm



19.0141.14
46.1451.09

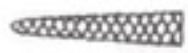

19.0140.14
46.1450.09

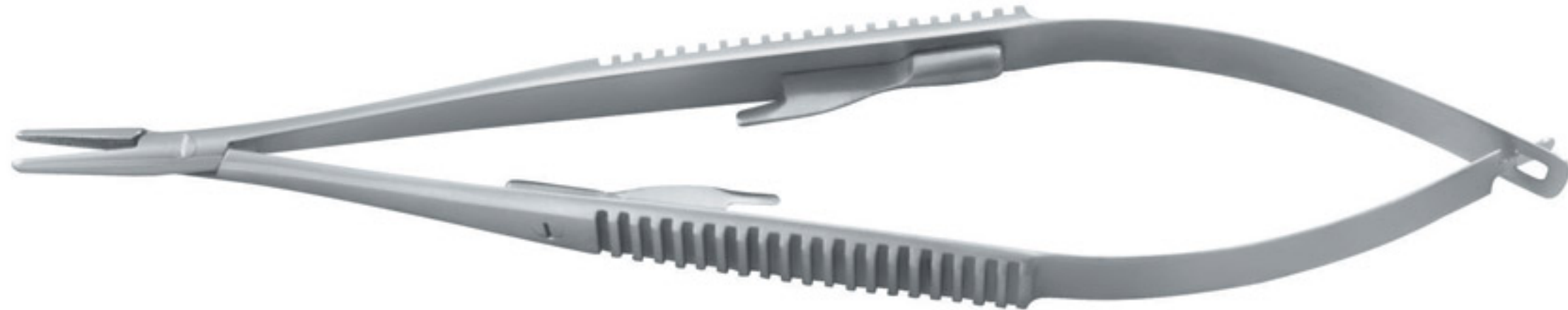

CASTROVIEJO
19.0140.14 - 19.0141.14
14 cm

19.1450.14 - 19.1451.14 (Titanium)
14 cm



46.0831.14
46.1831.14



46.0828.14
46.1828.14

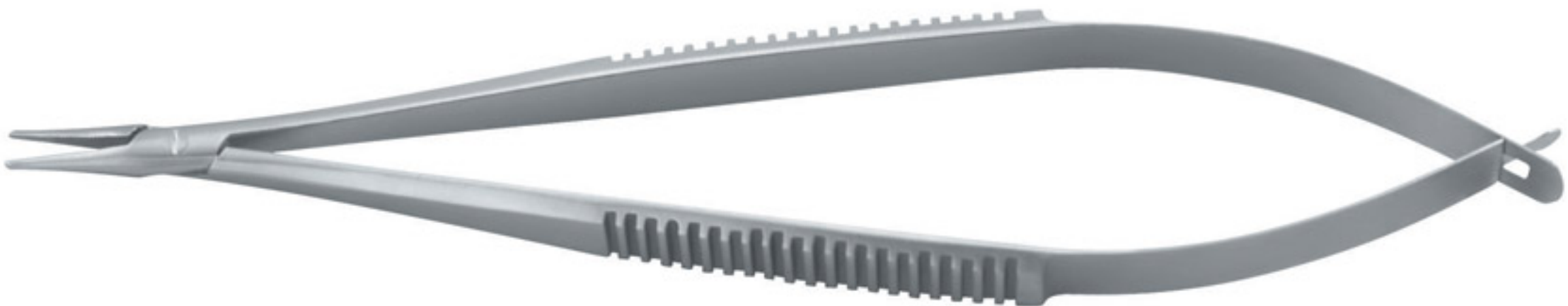

CASTROVIEJO
46.0828.14 - 46.0831.14
14 cm

46.1828.14 - 46.1831.14 (Titanium)
14 cm



46.0825.14
46.1825.14



46.0822.14
46.1822.14

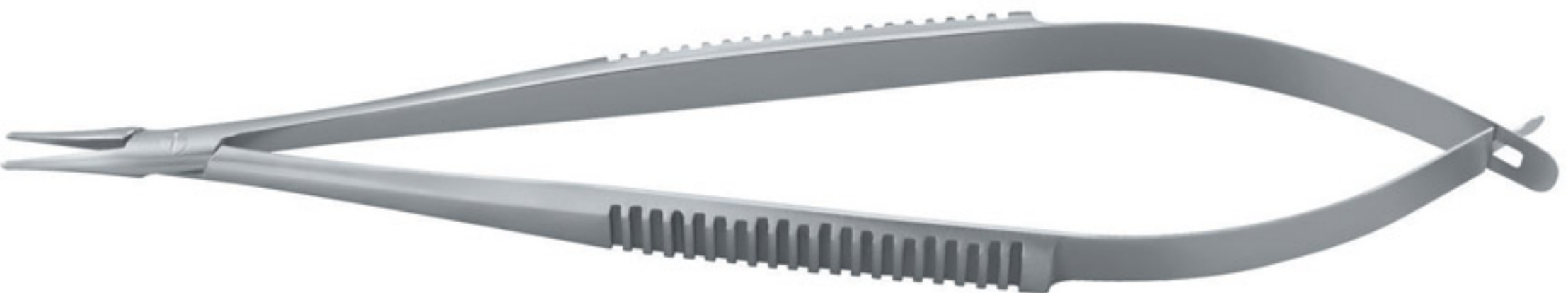

CASTROVIEJO
46.0822.14 - 46.0825.14
14 cm

46.1822.14 - 46.1825.14 (Titanium)
14 cm



CASTROVIEJO
45.1712.14
14 cm
46.1713.14 (Titanium)
14 cm



46.0669.14

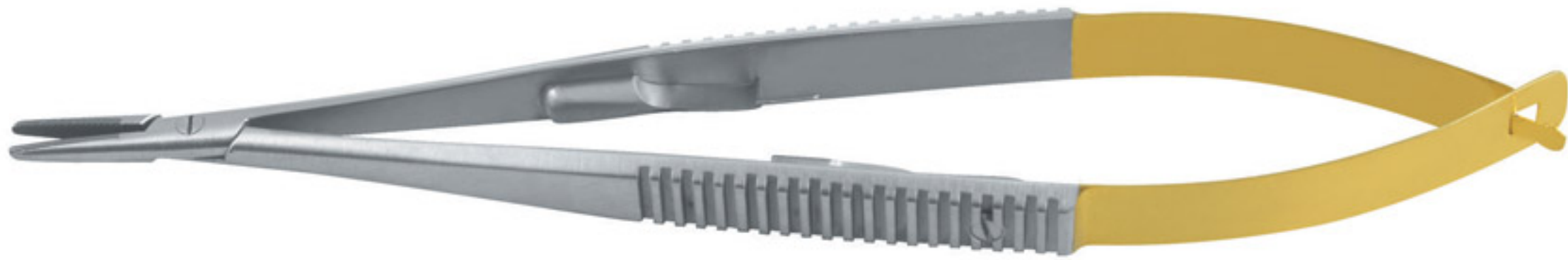

46.0664.14

CASTROVIEJO
46.0664.14 - 46.0669.14
14 cm



46.0971.13



46.0968.13

CASTROVIEJO
46.0968.13 - 46.0971.13
13 cm

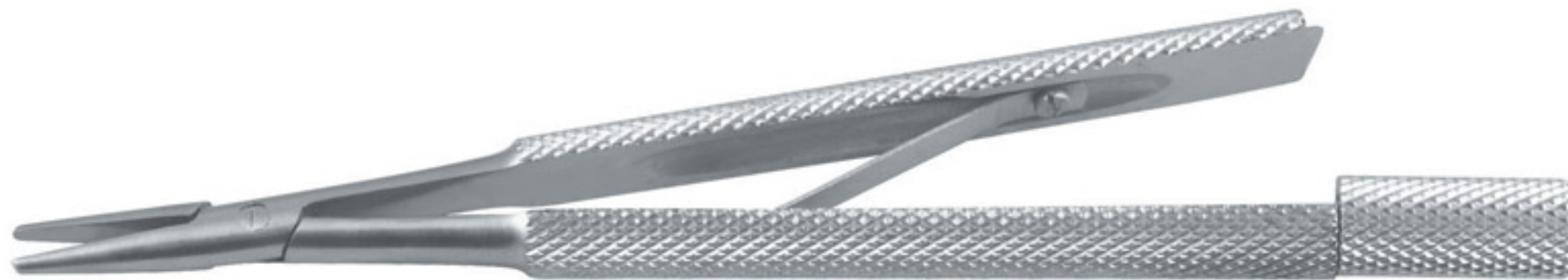

CASTROVIEJO
45.1724.08 9 cm
45.1728.13 13 cm



46.0887.14
46.1887.14



46.0884.14
46.1884.14

BARRAQUER
46.0884.14 - 46.0887.14
14 cm
46.1884.14 - 46.1887.14 (Titanium)
14 cm



BARRAQUER
46.0871.11
11 cm
46.1871.14 (Titanium)
11 cm



BARRAQUER
46.1708.14
14 cm
46.1709.14 (Titanium)
14 cm

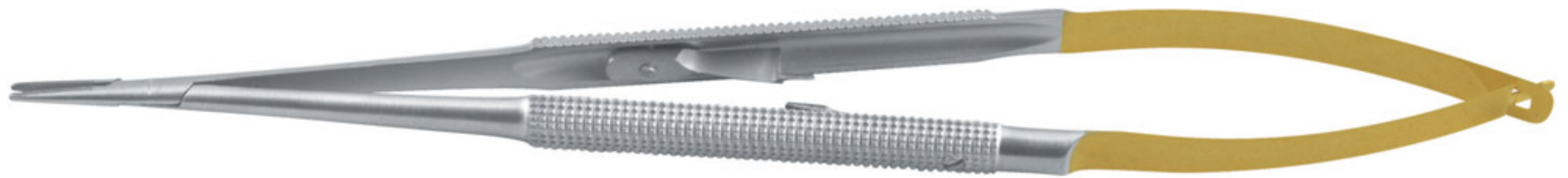

BARRAQUER
45.1716.18
18 cm



46.0791.14



46.0786.14



ARRUGA
46.0786.14 - 46.0791.14
14 cm



BARRAQUER
45.1720.11
11 cm



KALT
46.0796.14
14 cm



44.0436.13
13 cm

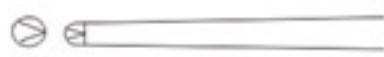

1x2 Teeth



44.0444.13
13 cm

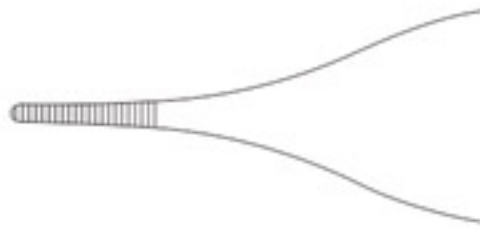

MICRO ADSON
44.130.12
12 cm



1x2 Teeth



MICRO ADSON
44.138.12
12 cm

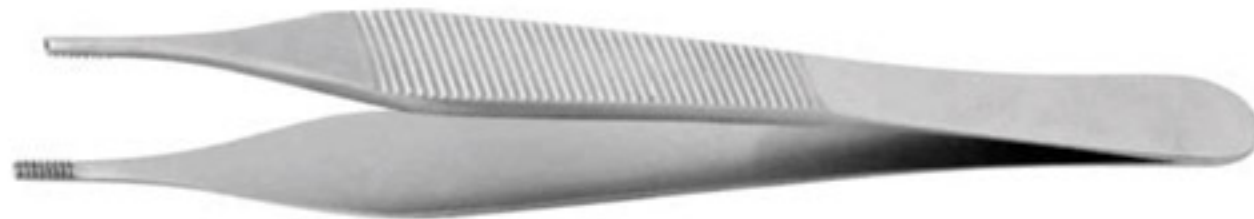

ADSON BROWN
44.1141.12
12 cm



Straight



SEMKEN
44.1145.12
12 cm



Curved



SEMKEN
44.1146.12
12 cm



POTTS-SMITH
44.916.18
18 cm

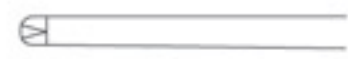

POTTS-SMITH
44.0948.18
18 cm



1.5 mm jaw



DEBAKEY "AT"
44.0000.15
15 cm

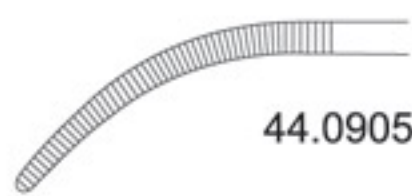

44.0905.17



CUSHING
44.0902.17 - 44.0905.17
17 cm



44.0902.17



LUCAE
44.1100.14
14 cm



GRUENWALD
(JANSEN)
44.1105.16
16 cm



JWELLER'S STYLE (WATCHMAKER)
45.0410.12
12 cm



JWELLER'S STYLE (WATCHMAKER)
45.1824.12
12 cm



GILLIES SHIN HOOK
48.0558.01
18 cm



KLIENERT KUTZ
48.0574.01
16 cm



JOSEPH DOUBLE SHIN HOOK
48.0628.16
16 cm



ROLLET
48.0616.13
13 cm



SENN-MILLER
48.0273.16
16 cm blunt



SENN-MILLER
48.0272.16
16 cm sharp



RAGNELL-DAVIS
48.0280.14
14 cm



DESMARRES SADDLE
48.1610.14
16 cm ,12 mm width

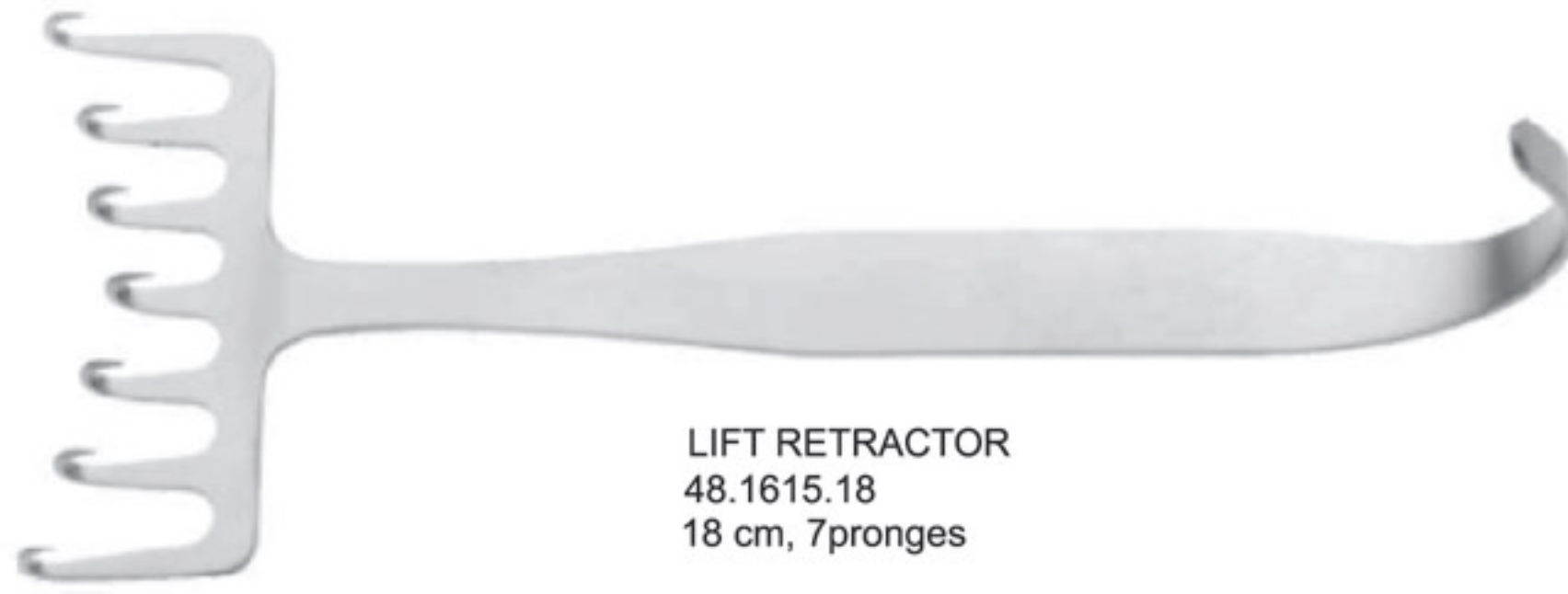

LIFT RETRACTOR
48.1615.18
18 cm, 7 pronges



MARTINEZ KILNR
48.1618.11
11.5 cm, 10 mm wide sharp



KILNR ALAE RETRACTOR
48.1620.08
8.5 cm 10mm sharp prong



FORMAN ALAE RETRACTOR
48.1623.16
16 cm



COTTLE HOOK
48.1625.16
14 cm, 1 prong blunt ball & sharp tip



OBWEGESR
48.1698.15
15 cm



DESCOLADOR
48.1630.20
20 cm

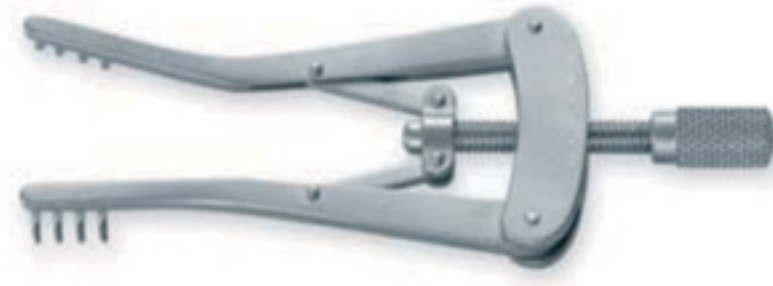

ALM
48.0284.07
7 cm 4x4 teeth



WEITLANER
48.1244.10 10.5 cm
18.1245.13 13.5 cm



WEITLANER
48.1257.13
13 cm



LAVASSIER
48.1635.00



BAUER DIREITO
48.1638.01 Right
48.1640.02 Left



SAGITAL DIREITO
48.1642.01 Right
48.1645.02 Left



OBWEGESER
48.1650.00 11 x 65 mm
48.1653.00 11 x 80 mm



OBWEGESER
48.1658.00 11 x 42 mm
48.1671.00 11 x 62 mm



OBWEGESER
48.1673.00 11 x 42 mm
48.1676.00 11 x 62 mm



MINNESOTA / ASPIRADOR
48.1679.14
14 cm



OBWEGESER
48.1682.17
17 cm



OBWEGESER
48.1685.18
18 cm



WIEDER
48.1688.00



BAUER DIREITO
48.1692.24 Right
48.1695.24 Left
24 cm



AUFRICHT NASAL
50.1628.16
16 cm



JOSEPH SAW
50.1629.19
19 cm



JOSEPH SAW
50.1630.00 left
50.1631.00 right
125 mm x 85 mm



BALLENGER SWIVEL KNIFE
50.1632.19
19 cm

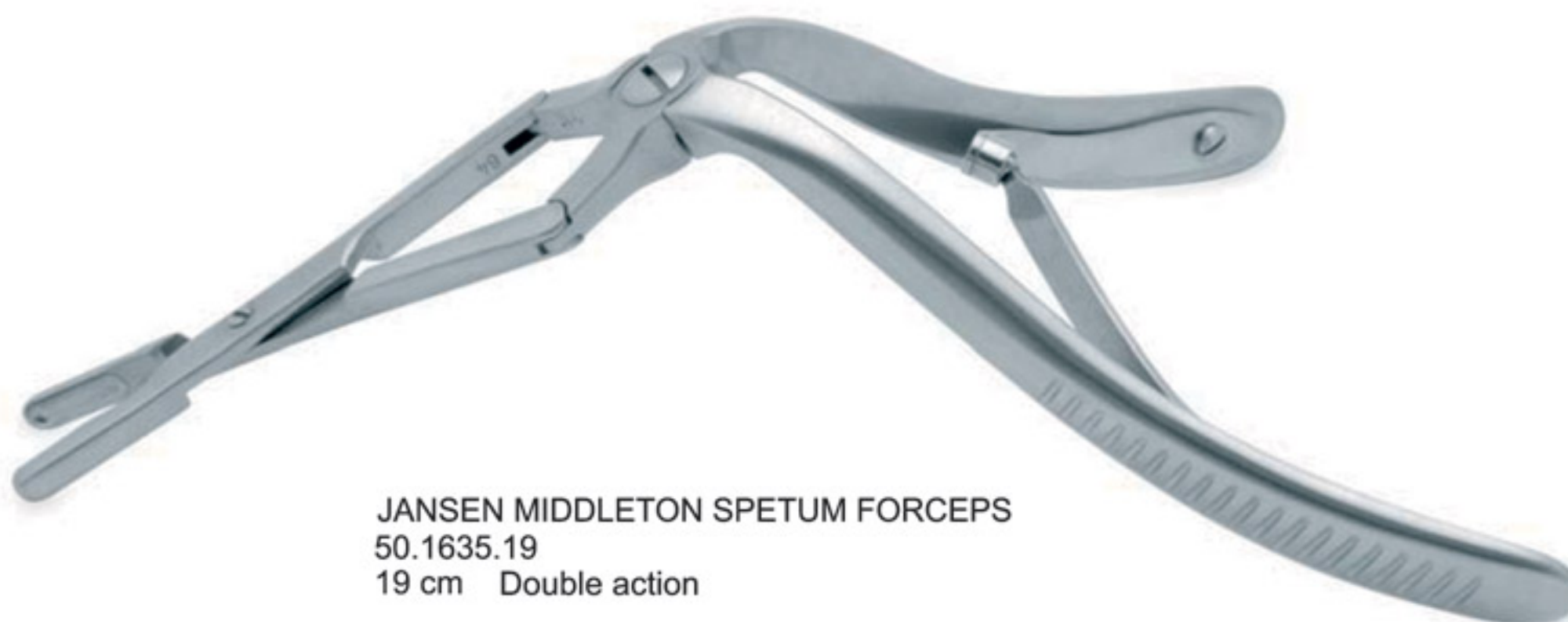

JANSEN MIDDLETON SPETUM FORCEPS
50.1635.19
19 cm Double action



WATSON SKIN GRAFT KNIFE
41.1350.30
30 cm



BRAITHWAITE SKIN GRAFT KNIFE
41.1355.30
30 cm



FORMAN DOUBLE END NASAL RASP
21 cm, T/c



50.1640.21



50.1642.21



50.1644.21



PARKES NASAL RASP
Backward cutting
21 cm, T/c



50.1646.21

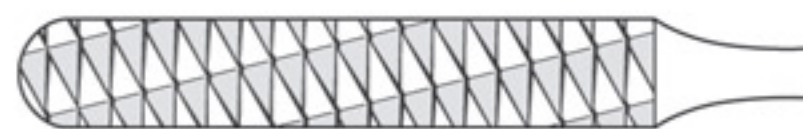

50.1648.21

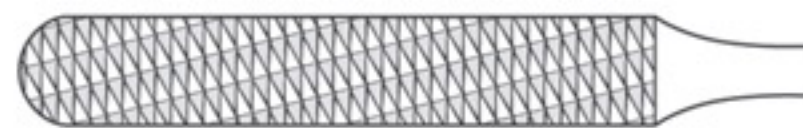

50.1650.21



MALTZ
50.1652.18
18.5 cm



MALTZ T/c
50.1654.18
18.5 cm



WAGNER
57.1501.00 4mm
50.1503.00 6mm
50.1507.00 8mm



WAGNER
57.1511.00 6mm
50.1515.00 8mm



WAGNER
57.1519.00 4mm



MEAD
57.0102.17
17 cm, ø 26 mm

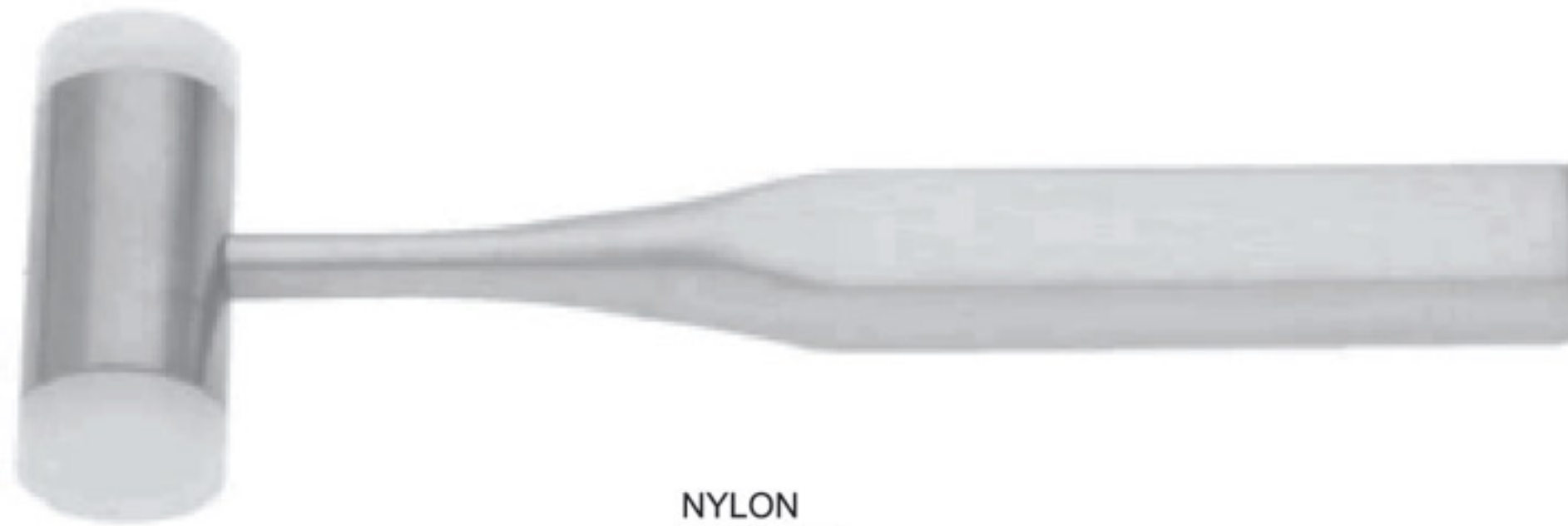

NYLON
57.1525.00
18.5 cm



GERZOG
57.1530.00
18 cm, 250g



COTTLE
15 cm / 6"

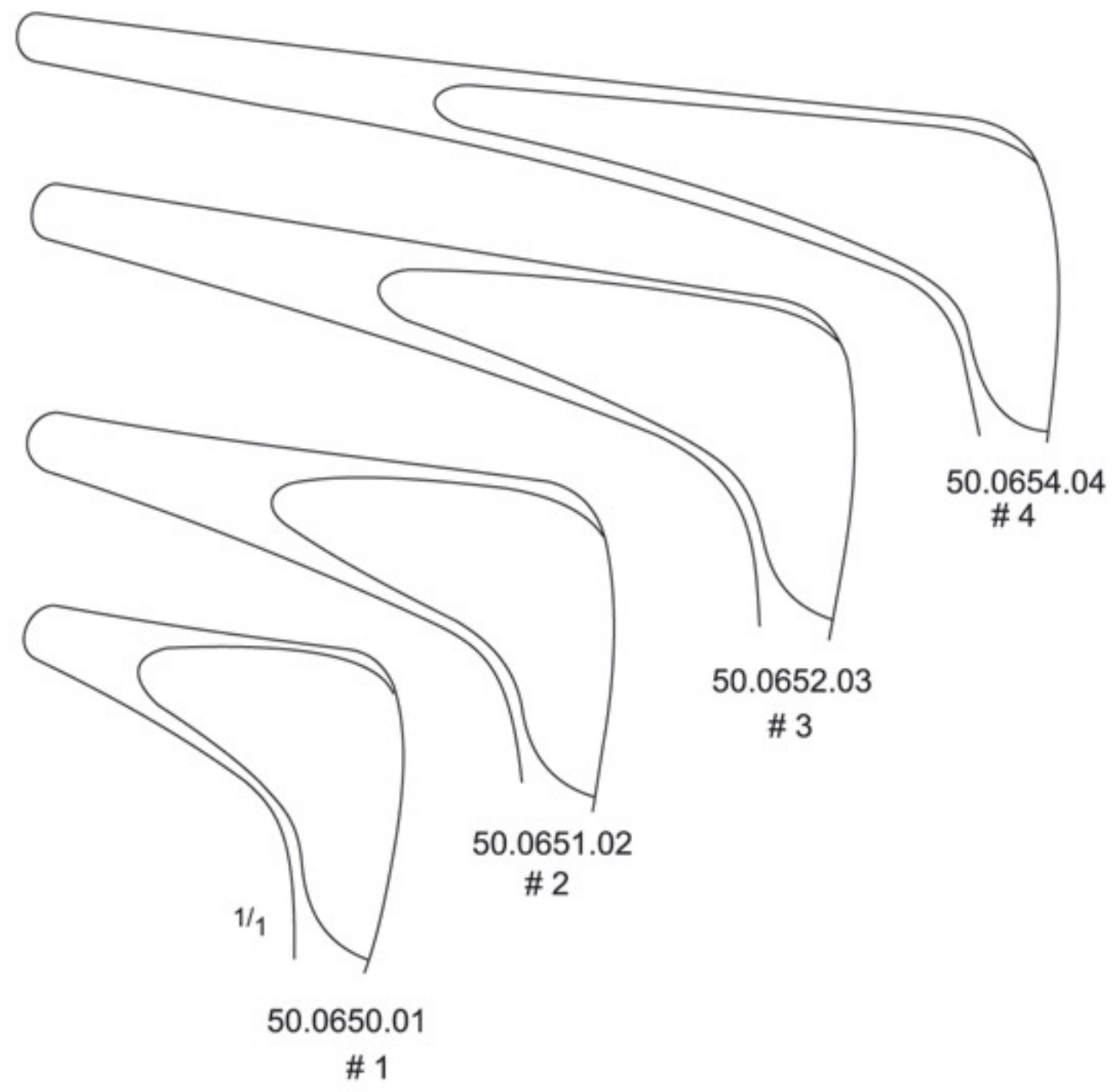

HARTMANN-HALLE
15 cm / 6"

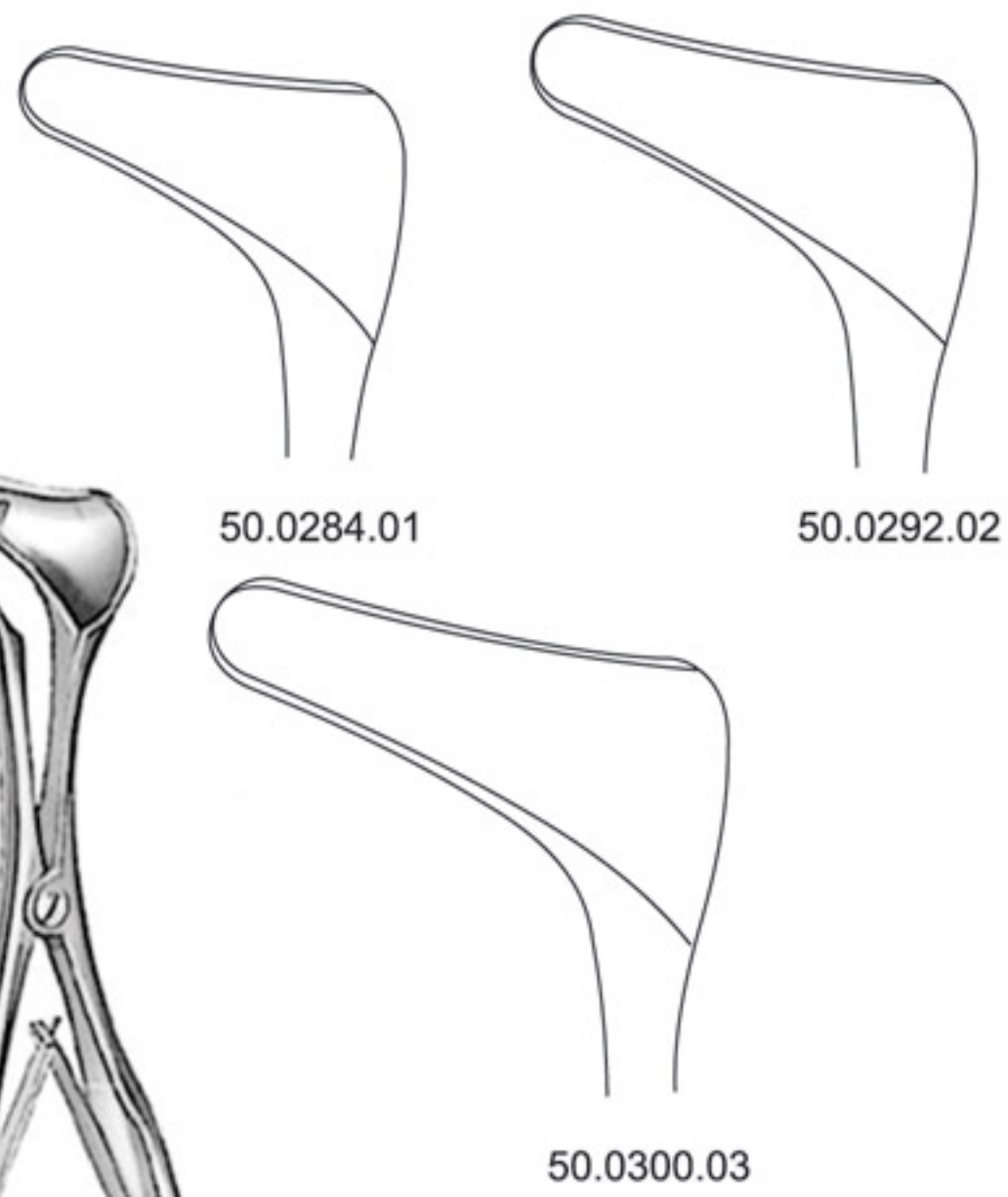



KILLIAN
14 cm / 5 1/2"

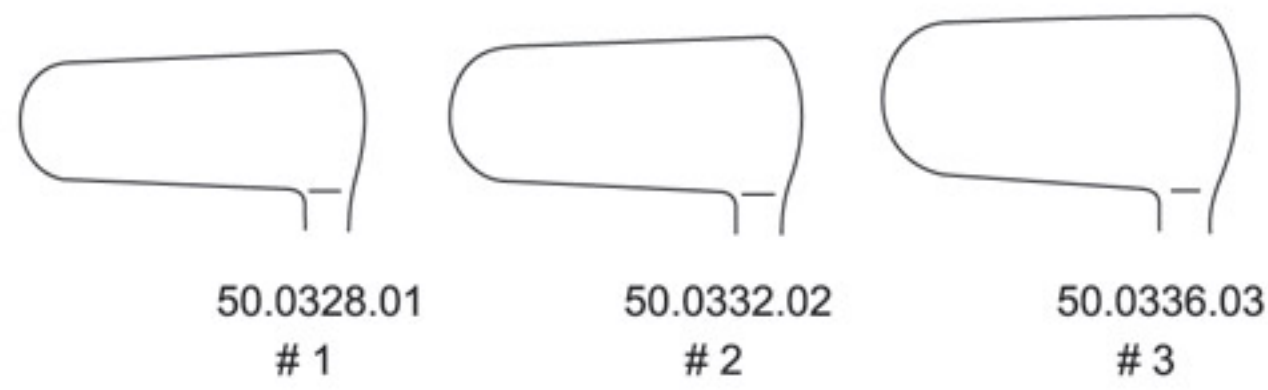
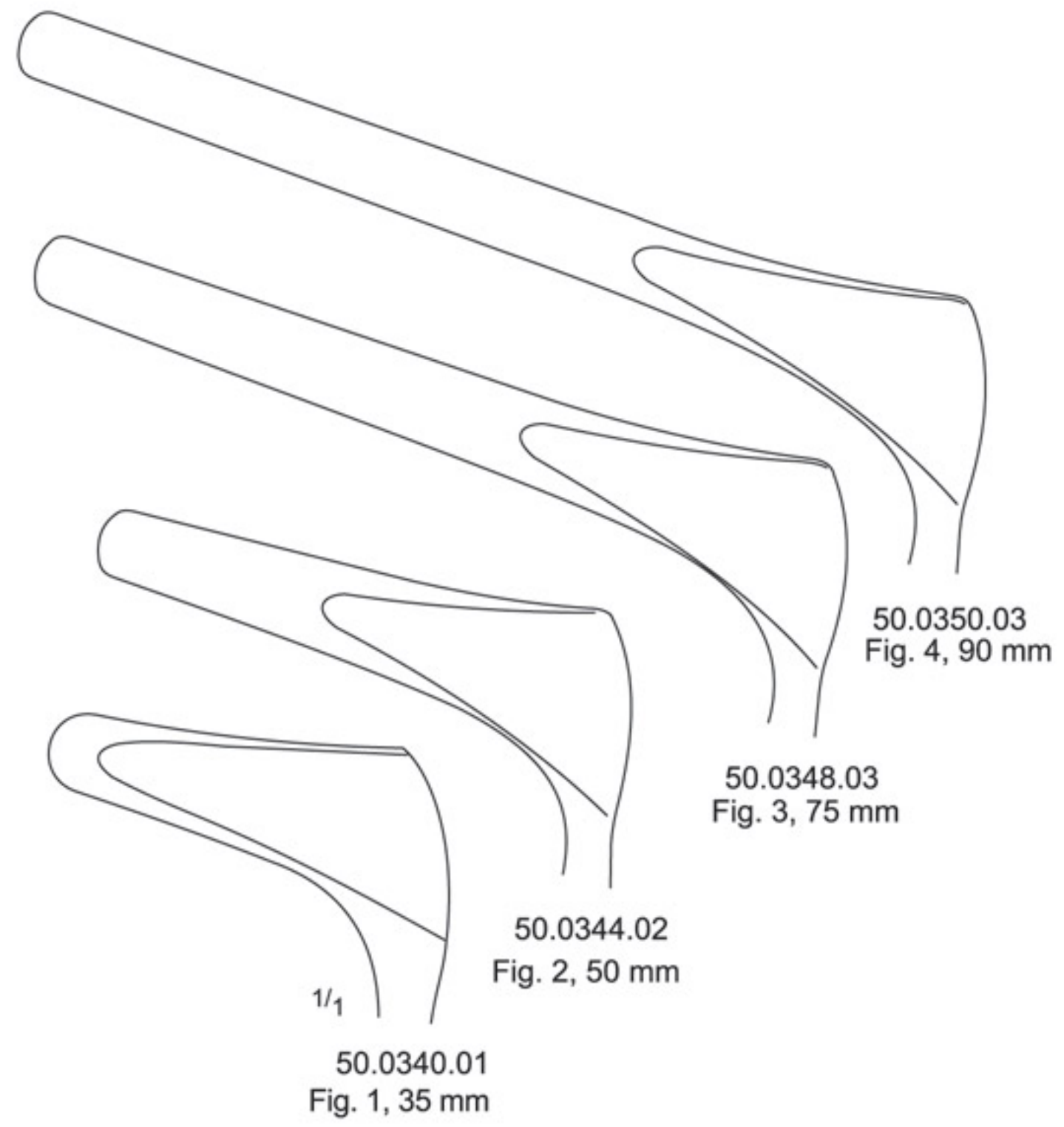

GOLDSMITH (THUDICUM)
6.5 cm / 2 1/2"

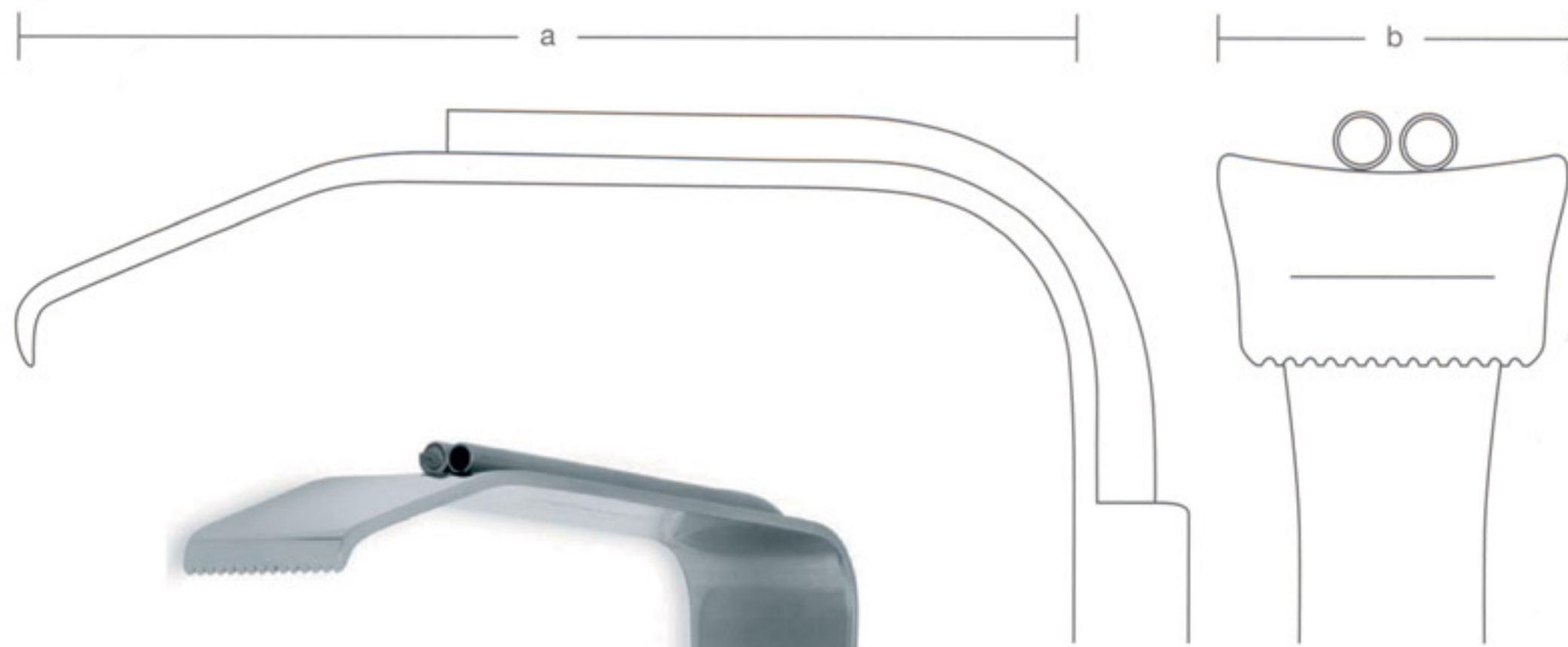

	(A)	(B)
50.1675.18	90	24 mm
50.1677.18	90	30 mm
50.1679.18	115	24mm

TEBBETTS
18.5 cm



BREAST RETRACTOR
Fiber optic & Adapter
48.1708.00 70 x 16 mm
48.1712.00 90 x 27 mm



BREAST RETRACTOR
Fiber optic & Adapter
48.1716.00 130 x 16 mm
48.1720.00 150 x 25 mm
48.1724.00 180 x 16 mm
48.1728.00 150 x 16 mm
48.1732.00 180 x 25 mm
48.1736.00 220 x 27 mm



BREAST RETRACTOR
Suction
48.1740.00 80 x 16 mm
48.1744.00 90 x 27 mm
48.1744.00 150 x 25 mm



BREAST RETRACTOR
Suction Size Angle
48.1750.00 180 x 16 mm 120°
48.1756.00 180 x 25 mm 120°
48.1760.00 180 x 27 mm 120°
48.1776.00 180 x 30 mm 120°



BREAST RETRACTOR

Suction	Size	Angle
48.1768.00	180 x 16 mm	130°
48.1772.00	180 x 25 mm	130°
48.1777.00	180 x 27 mm	130°
48.1780.00	180 x 30 mm	130°



BREAST RETRACTOR

Fiber Optic	Size
48.1784.00	270 x 45 x 25 mm



TEBBETS STYLE

Fiber Optic	Size
48.1788.00	80 x 16 mm
48.1792.00	90 x 30 mm
48.1794.00	90 x 24 mm
48.1798.00	36 x 16 mm
48.1802.00	100 x 25 mm
48.1806.00	120 x 25 mm
48.1810.00	150 x 25 mm
48.1814.00	150 x 30 mm



TEBBETS STYLE

Fiber Optic	Size
48.1818.00	70 x 14 mm
48.1822.00	80 x 16 mm
48.1826.00	230 x 13 mm
48.1830.00	230 x 25 mm
48.1834.00	100 x 25 mm
48.1838.00	120 x 25 mm
48.1842.00	120 x 30 mm
48.1846.00	150 x 25 mm
48.1850.00	150 x 30 mm



WIEDER RETRACTOR
Suction Size
48.1900.00 130 x 30 mm
48.1904.00 130 x 40 mm



WIEDER RETRACTOR
Suction Size
48.1908.00 130 x 30 mm
48.1912.00 130 x 40 mm



SPECULAMS
Fiber Optic Size
48.2260.00 35 x 130 mm
48.2264.00 50 x 130 mm
48.2268.00 75 x 130 mm
48.2272.00 90 x 130 mm



SPECULAMS
Fiber Optic Angle
48.2500.00 75° 8FR
48.2504.00 75° 10FR
48.2508.00 30° 8FR
48.2512.00 30° 10FR

One central hole / two lateral holes

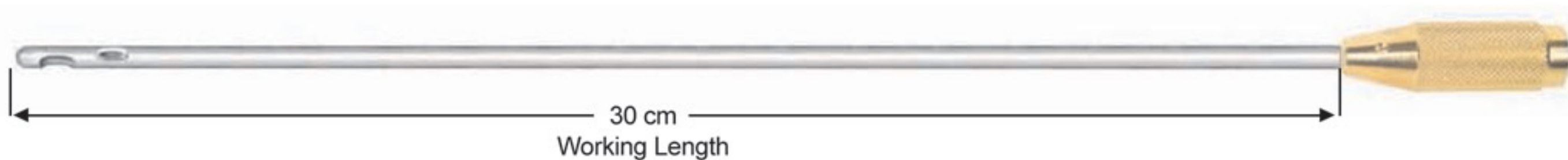

100-101.30
30 cm
ø 5mm



100-102.30
30 cm
ø 5mm



Three holes, diagonal



100-104.20
20 cm
ø 3 mm



100-105.30
30 cm
ø 4 mm



100-106.30
30 cm
ø 5 mm



100-107.40
40 cm
ø 6 mm



For infiltration



100-110.25
25 cm
ø 2 mm



100-111.25
25 cm
ø 3 mm

Point with hole/one lateral hole

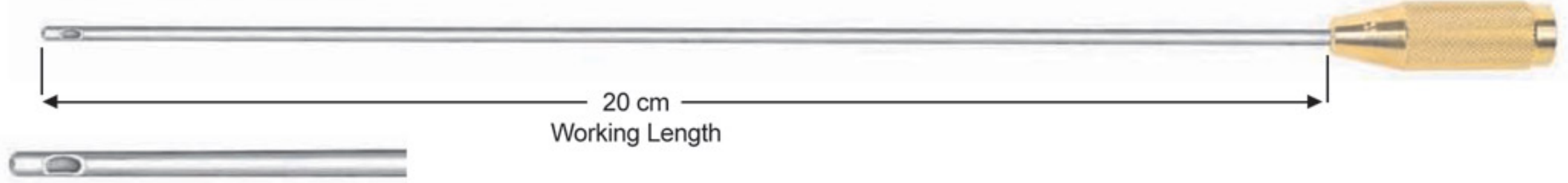

100-115.20
20 cm
ø 3mm

100-116.30
30 cm
ø 3mm



6x10 mm



100-117.30
30 cm

100-118.35
35 cm



One lateral hole
For fine proportioning in facial sections



100-119.05
5 cm
ø 1.7 mm

100-120.06
15 cm
ø 1.7 mm



100-121.05
5 cm
ø 2.0 mm

100-122.06
15 cm
ø 2.0 mm



100-123.05
5 cm
ø 3.0 mm

100-124.06
15 cm
ø 3.0 mm



100-125.05
5 cm
ø 1.7 mm



100-126.06
15 cm
ø 1.7 mm



100-127.05
5 cm
ø 2.0 mm



100-128.06
15 cm
ø 2.0 mm



100-129.05
5 cm
ø 3.0 mm

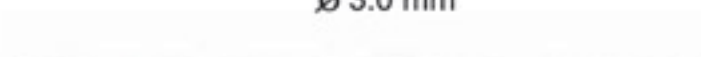

100-130.06
15 cm
ø 3.0 mm

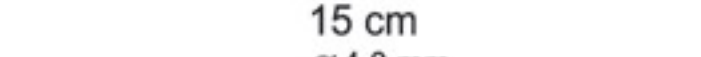

100-131.15
15 cm
ø 3.0 mm

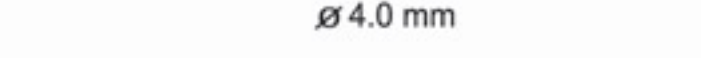

100-132.25
25 cm
ø 3.0 mm



100-133.15
15 cm
ø 4.0 mm



100-134.25
25 cm
ø 4.0 mm



100-135.20
20 cm
ø 3.0 mm

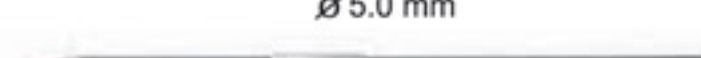

100-136.30
30 cm
ø 4.0 mm

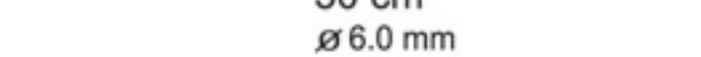

100-137.30
30 cm
ø 5.0 mm

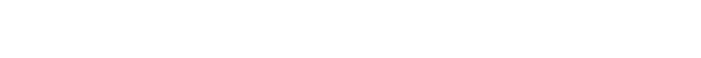

100-138.30
30 cm
ø 6.0 mm

One lateral hole

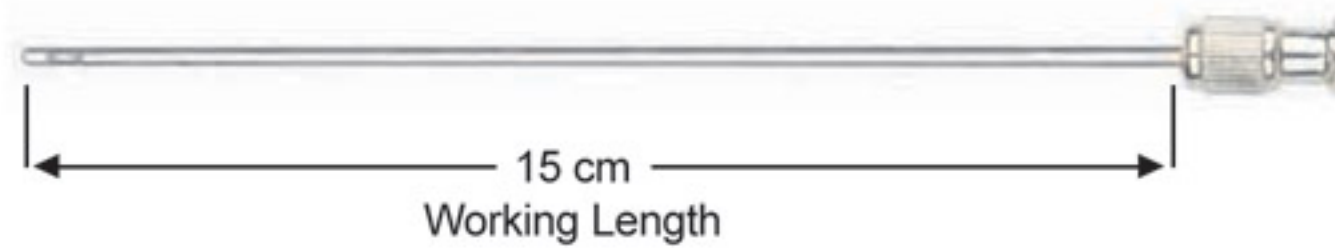

with LUER-LOCK connector

three lateral holes

One central hole, two lateral holes

18 Holes



15 cm
Working Length

hole \varnothing 1.0 mm



100-139.15
15 cm
 \varnothing 2.0 mm

hole \varnothing 1.5 mm



100-140.15
15 cm
 \varnothing 3.0 mm

18 Holes



hole \varnothing 1.0 mm



100-141.15
15 cm
 \varnothing 2.0 mm

hole \varnothing 1.5 mm



100-142.15
15 cm
 \varnothing 3.0 mm

22 Holes



hole \varnothing 1.5 mm



100-143.20
20 cm
 \varnothing 3.0 mm

hole \varnothing 2.0 mm



100-144.20
20 cm
 \varnothing 4.0 mm

22 Holes



hole \varnothing 1.5 mm



100-145.20
20 cm
 \varnothing 3.0 mm

hole \varnothing 2.0 mm



100-146.20
20 cm
 \varnothing 4.0 mm

The bayonet shaped handles allow an easier manipulation.

22 Holes



hole \varnothing 1.5 mm

100-147.20
20 cm
 \varnothing 3.0 mm



hole \varnothing 2.0 mm

100-148.20
20 cm
 \varnothing 4.0 mm

22 Holes



hole \varnothing 1.5 mm

100-149.20
20 cm
 \varnothing 3.0 mm



hole \varnothing 2.0 mm

100-150.20
20 cm
 \varnothing 4.0 mm

8 Holes



hole \varnothing 1.0 mm

100-151.15
15 cm
 \varnothing 2.0 mm



8 Holes



hole \varnothing 1.0 mm

100-152.15
15 cm
 \varnothing 2.0 mm

Handle with connection thread for cannulas hose
connection \varnothing 13mm for operation with a suction pump.



100-153.00

with rotatable tube connection



100-154.00



100-155.00

with rotatable tube connection



100-156.00





medisana
International

Medisana International

P.O. Box 1357

Sialkot – Pakistan

Tel: 0092 52 4293666

Email: info@medisanaintl.com